

DISTRIBUIDOR: □

□

SYMTA, S.A.L. □

SAN MAXIMO, 31 □

28041-MADRID □

□

TLF.: 91 500 2060 □

FAX: 91 500 0045 □

Correo-e: info@symta.com



LabHut.com

tablet dissolution accessories

in association with





LabHut.com

tablet dissolution accessories

LabHut.com is an international supplier of chromatography and dissolution products with over a decade's experience of supplying quality dissolution products to the international market. We can supply dissolution products for all OEMs and custom dissolution parts for most applications.

Order online at: www.labhut.com

More than just a Product Catalogue...

Information ⓘ
Technical information such as USP guidelines and descriptions/diagrams of USP Apparatus

Key Considerations ⓘ
Important information and advice, such as correct use of products, materials information and product variations/alternatives

Care & Maintenance ⚙️
Cleaning, handling and storage guidelines

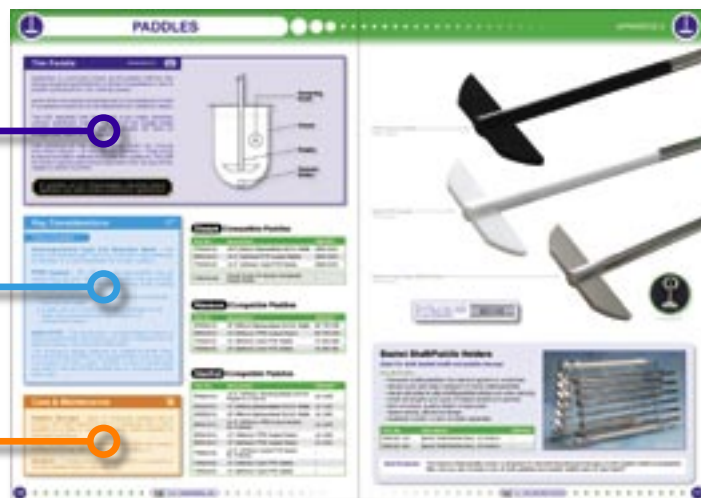

Manufacturer (OEM) References

Equivalent manufacturer product part numbers appear in 'OEM Ref' columns of product listings.

An OEM Reference located within a product listing that is not attributed to a specific manufacturer will have the relevant manufacturer's initial icon adjacent to it.

When a dash (-) appears in the OEM Ref column for a product listing attributed to a specific manufacturer, it signifies an innovated product designed for use in that manufacturer's dissolution applications. Dashes elsewhere signify universal products which can be used in all dissolution applications.

Manufacturers:

Caleva

Distek

Erweka

Hanson

Pharmatest

Sotax

VanKel

Zymark

(Varian)

(Caliper LifeSciences)

If you cannot find what you need
please contact us























✉️ sales@labhut.com

☎️ +44 (0)1452 310210

📠 +44 (0)1452 300075

All LabHut.com tablet dissolution accessories are U.S. Pharmacopeia compliant where applicable and meet machine manufacturer specifications

	BASKETS	4
	BASKET SHAFTS	8
	SPIN SHAFT ACCESSORIES	9
	PADDLES	10
	CAPSULE SINKERS	12
	VESSELS	16
	VESSEL COVERS	20
	FILTERS	22
	SAMPLING CANNULAE	26
	TRANSDERMAL TESTING	32
	BIODISSOLUTION ACCESSORIES	34
	FELODIPINE TEST BASKET	35
	CALIBRATION TOOLS	36
	GLASS ACCESSORIES	38
	I INTRINSIC DISSOLUTION	39
	DISINTEGRATION	40
	Z CALIPER LIFESCIENCES (ZYMARK)	41
	MISC ACCESSORIES	42
	OEM INDEX – OEM REFERENCE	43
	INDEX – PART NUMBER	45



BASKETS



The Basket Method

APPARATUS 1



Adopted in 1970 the rotating basket method of dissolution testing was the first official method. It essentially consists of an approximately 1 inch (25.4mm) x 1 3/8 inch (34.925mm) stainless steel, 40-mesh wire basket rotated at a constant speed between 25 and 150rpm. This method is now called Apparatus 1 (or Method 1).

The apparatus consists of a metallic drive shaft connected to the cylindrical basket. The basket is positioned inside a vessel made of glass or other inert, transparent material (see page 16). The vessel contents are kept at a constant temperature by being placed inside a water bath or heating jacket. The solution in the vessel is stirred smoothly by the rotating basket.

The USP Method 1 requires a 40-mesh screen unless otherwise specified in the monograph. Other meshes can be used to solve individual problems.

Baskets and basket shafts should be serialised where possible and the serial number noted for each test.

All baskets are U.S. Pharmacopeia compliant where applicable and meet machine manufacturer specifications

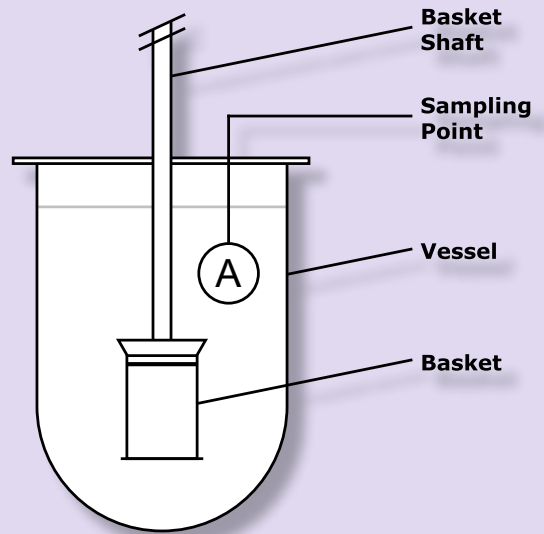

Key Considerations



Mesh Openings – One of the biggest problems associated with the basket method involves the clogging of the mesh openings by particles or excipients or the random release of particles through the mesh to the bottom of the vessel.

Baskets with a wide variety of mesh openings are available and if the disaggregated particle size is consistent, a variation of mesh size may solve some difficult dissolution problems.



10 Mesh



20 Mesh



40 Mesh

Sintered Mesh – Every LabHut stainless steel basket is manufactured using a sintered mesh. Sintering is a strengthening process that compresses and heats the mesh under high pressures and temperatures. This results in welded joints at all the wire overlaps and adds considerable strength and longevity to the basket.

Suppository Baskets – Made from plastic, these baskets have vertical slots instead of mesh to facilitate dissolution. Blocking and/or clogging of the mesh opening is prevented by the use of such a basket, particularly when oil-based suppositories are used.



Care & Maintenance



Basket Handling – Dissolution basket mesh is easily bent and good practice dictates that a basket should only be handled by the rim, not least because oily deposits from fingers can be left on the mesh.

Basket Cleaning – Care should be exercised to ensure that baskets are clean prior to use. Often the dosage form can clog the mesh which will prevent free media movement into the basket. Careful cleaning is required to ensure there is no contamination between tests.

Basket Storage – Baskets should be stored correctly to extend their life. They can frequently be found rolling around in a lab drawer! Baskets can easily be stored in the supplier's case or using a specially designed basket holder. See page 7.

All baskets are laser marked with a unique serial number for easy identification



For EXPERT ADVICE on obtaining the best basket for your application email sales@labhut.com



Caleva Compatible Baskets

Part No.	Description	OEM Ref
BSK010-CA	10 Mesh Stainless Steel Basket	0810123
BSK020-CA	20 Mesh Stainless Steel Basket	0810021
BSK040-CA	40 Mesh Stainless Steel Basket	0810019
BSKSUP-CA	Suppository Basket, Plastic	-



BSK010-CA



BSK020-CA



BSK040-CA



BSKSUP-CA

Distek Compatible Baskets

Part No.	Description	OEM Ref
BSK010-DK	10 Mesh Stainless Steel Basket	2821-0160
BSK010-DKC	10 Mesh Stainless Steel Basket, Evolution Series	2800-0041
BSK020-DK	20 Mesh Stainless Steel Basket	2821-0159
BSK020-DKC	20 Mesh Stainless Steel Basket, Evolution Series	2800-0042
BSK040-DK	40 Mesh Stainless Steel Basket	2821-0072
BSK040-DKC	40 Mesh Stainless Steel Basket, Evolution Series	2800-0032
BSKPTD-40	40 Mesh PTFE Coated Basket	-
BSKSUP-DK	Suppository Basket, Plastic	3250-0445



BSK010-DK



BSK010-DKC



BSK020-DK



BSK020-DKC



BSK040-DK



BSK040-DKC



BSKSUP-DK

Erweka Compatible Baskets

Part No.	Description	OEM Ref
BSK020-EW	20 Mesh Stainless Steel Basket	90-000-0015
BSK040-EW	40 Mesh Stainless Steel Basket	90-000-0040
BSKSUP-EW	Suppository Basket, Plastic	-



BSK020-EW



BSK040-EW



BSKSUP-EW



BASKETS



Hanson Compatible Baskets

Part No.	Description	OEM Ref
BSK010-HR	10 Mesh Stainless Steel Basket	65-220-010
BSK020-HR	20 Mesh Stainless Steel Basket	65-220-020
BSK040-HR	40 Mesh Stainless Steel Basket	65-220-000
BSKPTH-40	40 Mesh PTFE Coated Basket	-
BSKSUP-HR	Suppository Basket, Plastic	65-700-048



BSK010-HR



BSK020-HR



BSK040-HR



BSKPTH-40



BSKSUP-HR

Pharmatest Compatible Baskets

Part No.	Description	OEM Ref
BSK010-PT	10 Mesh Stainless Steel Basket	-
BSK020-PT	20 Mesh Stainless Steel Basket	-
BSK040-PT	40 Mesh Stainless Steel Basket	-
BSKSUP-PT	Suppository Basket, Plastic	-



BSK010-PT



BSK020-PT



BSK040-PT



BSKSUP-PT

Sotax Compatible Baskets

Part No.	Description	OEM Ref
BSK010-SX	10 Mesh Stainless Steel Basket	-
BSK020-SX	20 Mesh Stainless Steel Basket	-
BSK040-SX	40 Mesh Stainless Steel Basket	2830
BSKSUP-SX	Suppository Basket, Plastic	-



BSK010-SX



BSK020-SX



BSK040-SX



BSKSUP-SX



VanKel Compatible Baskets

Part No.	Description	OEM Ref
BSK010-01	10 Mesh Stainless Steel Basket	12-2125
BSK020-01	20 Mesh Stainless Steel Basket	12-2120
BSK040-01	40 Mesh Stainless Steel Basket	12-2100
BSK040-01PL	40 Mesh Precision Length Stainless Steel Basket	-
BSKPTV-40	40 Mesh PTFE Coated Basket	12-2110
BSK100-01	100 Mesh Stainless Steel Basket	12-2154
BSK150-01	50x150 Mesh Stainless Steel Basket	12-2152
BSKSUP-01	Suppository Basket, Plastic	12-2130



BSK010-01



BSK020-01



BSK040-01



BSKPTV-40



BSKSUP-01

STABSK-10	Stationary Basket Assembly with Basket Shaft and 10 Mesh Basket	12-2061
STABSK-20	Stationary Basket Assembly with Basket Shaft and 20 Mesh Basket	12-2060
STABSK-40	Stationary Basket Assembly with Basket Shaft and 40 Mesh Basket	12-2063



STABSK-10



STABSK-20



STABSK-40



USP 26 Felodipine Test Basket – See page 35

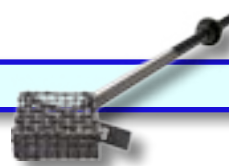

Dissolution Basket Storage

Prolong the life of baskets and save money

To ensure they meet USP requirements, it is essential that for all tests, baskets are not bent or deformed.

The chances of accidentally damaging baskets can be significantly reduced with the use of a good quality basket holder, such as this.

Key Benefits:

- **Compatible** with all popular basket types (Caleva, Distek, Erweka, Hanson, Pharmatest, Sotax, VanKel, Zymark)
- O-rings ensure baskets are **held firmly** to the holder
- Stores up to **12 baskets**
- **Fully stackable**, letting you transport many baskets at a time
- **Low cost** – it pays for itself by preventing damage to just one basket!



Part No.	Description	OEM Ref
BSKHLD-12	Stackable Dissolution Basket Holder, 12 Position	-

The Basket Shaft

APPARATUS 1



The basket shaft is the metallic drive shaft in Apparatus 1 which is connected to the cylindrical basket. See page 4 for more information on Apparatus 1.

All shafts are constructed from type 316 electropolished stainless steel.

Key Considerations



Clip or Clipless?

Spring Clips – The standard dissolution basket is designed to attach to the basket shaft using spring clips. Over time these clips can become bent or corroded which can lead to excessive wobble of the basket on the shaft.

O-Ring – The clipless basket fixes to the shaft using an O-ring instead of clips. While it can be argued that this design reduces wobble and is easier to use, the USP still specifies the use of clips and proof of equivalence may be required if a clipless alternative is to be used.

Care & Maintenance



Shaft Storage – Bent or scratched shafts fail to comply with USP regulations so it is essential not to store shafts on a desk or loose in a drawer where damage or corrosion can occur.

Proper storage in a basket shaft/paddle holder can prevent damage occurring. See page 11 for basket shaft holders.

Wobble – A Wobble Meter (WOBMET-MI) is available to monitor basket shaft wobble. See page 37.

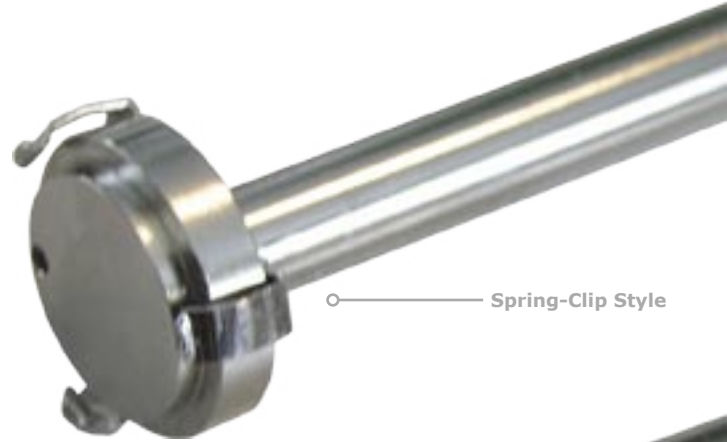

Spring-Clip Style



O-ring Style

All basket shafts are laser marked with a unique serial number for easy identification

Q03026

Distek Compatible Basket Shafts

Part No.	Description	OEM Ref
BSDRNG-16	16.5" (420mm) O-Ring Style Basket Shaft	2821-0074
BSHT16-02	16.5" (420mm) Spring Clip Style Basket Shaft	-
BSDRNG-19	19" (480mm) O-Ring Style Basket Shaft	2821-0097
SHFT16.5-DK	16.5" (420mm) Detachable Shaft	2800-0165
BSKHUB-DK	Basket Adaptor, O-Ring Style	2851-1052
BSKHUB-DKC	Basket Adaptor, Evolution Series Only	3200-0038
BSKCLP-DK	Basket Clip, Evolution Series Only	3100-0017

Hanson Compatible Basket Shafts

Part No.	Description	OEM Ref
BSKSHT-16	16" (405mm) Spring Clip Style Basket Shaft	65-237-000

VanKel Compatible Basket Shafts

Part No.	Description	OEM Ref
BSKSHT-13	13" (330mm) Spring Clip Style Basket Shaft	12-2073
BSKSHT-15	15" (380mm) Spring Clip Style Basket Shaft	12-2070
BSKSHT-15C	15" (380mm) Spring Clip Style Conical Basket Shaft	12-2075
BSKSHT-15CO	15" (380mm) O-Ring Style Conical Basket Shaft	12-2050
BSKSHT-19	19" (480mm) Spring Clip Style Basket Shaft	12-2080



SHFT16.5-DK



BSKHUB-DK



BSKHUB-DKC



BSKCLP-DK



BSKSHT-15C



BSKSHT-15CO



Spin Shafts

APPARATUS 1 / 2 / 6



Spin On/Off Shafts for Apparatus 1, 2 and 6 offer a quick, convenient change between paddle and basket methods without the need to reset the shaft height.

These two-piece basket/paddle/cylinder shafts join above the media to prevent potential contamination.

Key Considerations



Spin Shaft Features:

- Spin On/Off Shafts may be used in any VanKel dissolution apparatus, including the V-Series
- It is unnecessary to remove the shaft when changing apparatus
- There is no need to readjust shaft height or the locking mechanism
- The attachment connection for Spin On/Off Shafts is located outside the media, eliminating any chance of contamination
- Precision manufacturing has assured USP compliance and detachable components meet USP specifications
- Wobble data is well within USP tolerance
- Spin On/Off Shafts are engineered to minimise the risk of cross-threading and ensure a secure connection
- Spin On/Off Shafts are less expensive than maintaining two different sets of shafts

Care & Maintenance



Spin On/Off Shaft Storage – Bent or scratched shafts fail to comply with USP regulations so it is essential not to store shafts on a desk or loose in a drawer where damage or corrosion can occur.

Proper storage in a basket shaft/paddle holder can prevent damage occurring. See page 11 for basket shaft holders.

All spin shafts are laser marked with a unique serial number for easy identification

Q01259

VanKel Spin Shaft Accessories

Part No.	Description	OEM Ref
SPNSHT-13	Spin ON/OFF 14.5" (370mm) Shaft For V-Series (when fully assembled)	-
SPNSHT-15	Spin ON/OFF 15" (380mm) Shaft (when fully assembled)	12-1400
SPNSHT-19	Spin ON/OFF 19" (480mm) Shaft (when fully assembled)	12-1401
SPNBSK-01	Spin ON/OFF Spring Clip Style Basket Shaft, 316 S.S.	12-1430
SPNRNG-01	Spin ON/OFF O-Ring Style Basket Shaft, 316 S.S.	12-1431
SPNBSK-ZM2	Spin ON/OFF Double O-Ring Style Conical Basket Shaft, 316 S.S.	-
SPNEPD-01	Spin ON/OFF Electropolished 316 S.S. Paddle	12-1421
SPNNDP-01	Spin ON/OFF PTFE Coated Paddle	12-1420
SPNTPD-01	Spin ON/OFF Solid PTFE Paddle	-
SPNAP6-01	Spin ON/OFF USP APP 6 Rotating Cylinder for Transdermal Patches, Electropolished 316 S.S.	-





PADDLES



The Paddle

APPARATUS 2



Apparatus 2, commonly known as the paddle method, has similar physical specifications to those of Apparatus 1 with a paddle substituted for the rotating basket.

Some of the dimensions and tolerances for the paddle are critical if consistent results are to be obtained from vessel to vessel.

The USP specifies that the paddle must rotate smoothly without significant wobble. The arc of the paddle blade creates considerable flow and any wobble will have an exaggerated effect on the flow profile.

The contours of the paddle blade must not include any sharp edges – at the tips for instance – that could produce turbulent instead of laminar flow patterns. The USP constrains wobble and vertical alignment with the axis of the vessel to within $\pm 2.0\text{mm}$.

All paddles are U.S. Pharmacopeia compliant where applicable and meet machine manufacturer specifications

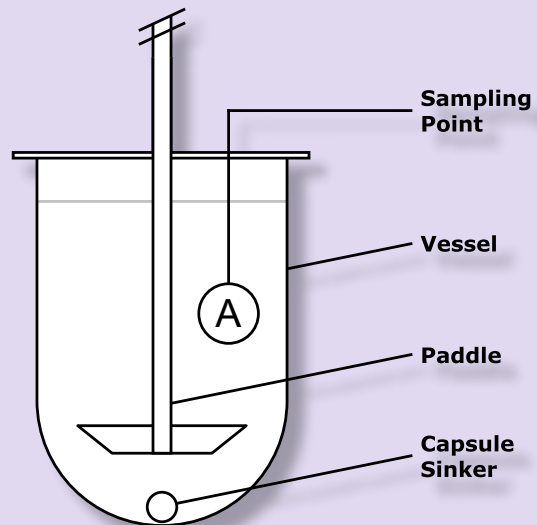

Key Considerations



Types of paddle:

Electropolished Type 316 Stainless Steel – The strong 316 stainless steel (316 S.S.) shaft has a high resistance to bending. It is electropolished for smooth rotation.

PTFE Coated – The USP suggests that paddles may be coated with an inert coating. Most paddles are accordingly coated with PTFE or another inert coating. Such coating serves two purposes:

- It prevents corrosion and the introduction of unwanted ions into the media
- It seals the joint where the blade is attached to the shaft, thus preventing the accumulation of contaminant traces

Solid PTFE – The single piece moulded design features a fluoropolymer blade and single-piece stem moulded over an electropolished, 316 stainless steel shaft.

The innovative design features no paddle-to-shaft joint, thus eliminating potential cross-contamination and removing a probable corrosion path. Wobble is also considerably reduced in the solid PTFE paddle due to its being a single piece cast.

Care & Maintenance



Paddle Storage – Bent or scratched paddles fail to comply with USP regulations so it is essential not to store paddles on a desk or loose in a drawer where damage or corrosion can occur.

Proper storage in a basket shaft/paddle holder can prevent damage occurring. See paddle holders on page 11.

Wobble – A Wobble Meter (WOBMET-MI) is available to monitor paddle wobble. See page 37.

Distek Compatible Paddles

Part No.	Description	OEM Ref
EPD016-02	16.5" (420mm) Electropolished 316 S.S. Paddle	2800-0010
NPD016-02	16.5" (420mm) PTFE Coated Paddle	2800-0002
TPD016-02	16.5" (420mm) Solid PTFE Paddle	2800-0178
TUMSCR-DK	Thumb Screw for Distek Compatible Paddle Shafts	-

Hanson Compatible Paddles

Part No.	Description	OEM Ref
EPD016-01	16" (405mm) Electropolished 316 S.S. Paddle	65-700-036
NPD016-01	16" (405mm) PTFE Coated Paddle	65-700-030
TPD016-01	16" (405mm) Solid PTFE Paddle	72-800-456
TPD018-01	18" (460mm) Solid PTFE Paddle	72-800-461

VanKel Compatible Paddles

Part No.	Description	OEM Ref
EPD013-01	14.5" (370mm) Electropolished 316 S.S. Paddle for V-Series	12-1035
EPD015-01	15" (380mm) Electropolished 316 S.S. Paddle	12-1030
EPD019-01	19" (485mm) Electropolished 316 S.S. Paddle	12-1040
NPD013-01	14.5" (370mm) PTFE Coated Paddle for V-Series	12-1005
NPD015-01	15" (380mm) PTFE Coated Paddle	12-1000
NPD019-01	19" (485mm) PTFE Coated Paddle	12-1010
TPD013-01	14.5" (370mm) Solid PTFE Paddle for V-Series	-
TPD015-01	15" (380mm) Solid PTFE Paddle	-
TPD019-01	19" (485mm) Solid PTFE Paddle	-



PTFE Coated Paddle (NPD series)



Solid PTFE Paddle (TPD series)



Polished Stainless Steel Paddle (EPD series)



All paddles are laser marked with a unique serial number for easy identification.



TUMSCR-DK

Basket Shaft/Paddle Holders

Ideal for both basket shaft and paddle storage

Key Benefits:

- Prevents shafts/paddles from becoming bent or scratched
- Allows quick and easy transport of many shafts/paddles
- Handy end plate to stop shafts/paddles sliding out when carrying
- Holds all lengths and types of basket shafts and paddles
- Non-corrosive, quality plastic construction
- Space-saving, attractive design
- Available in both 12 and 16 shaft capacities



PADHLD-12A

Part No.	Description	OEM Ref
PADHLD-12A	Basket Shaft/Paddle Rack, 12 Position	-
PADHLD-16A	Basket Shaft/Paddle Rack, 16 Position	-

Dual Purpose: This basket shaft/paddle holder is designed for optimal handling and storage of both basket shafts and paddles. Why not use one to keep a set of both paddles and basket shafts next to each bath?



CAPSULE SINKERS



The Sinker

APPARATUS 2



Floating tablets rarely dissolve at a reproducible rate. Using a sinker in Apparatus 2 fixes the tablet to a certain point and aids reproducibility. Sinkers can also be useful where tablets may stick to the sides of the vessel.

USP 711 states:

"A small, loose piece of non-reactive material such as not more than a few turns of wire helix may be attached to dosage units that would otherwise float. Other validated sinker devices may be used."

Once a sinker design is selected for a particular application, the dimensions and drawings should be recorded to ensure uniformity in the procedure.

Key Considerations



Inevitably, home-made sinkers tend not to be reproducible and so commercially available sinkers are quite popular. The choice of sinker will depend on the tablet or capsule.

General Guidelines:

- **Sinker Size** – The sinker should have minimal surface contact with the tablet as this can affect the dissolution rate. Sinkers are available in different sizes to accommodate most capsule/tablet dimensions. See the sinker and capsule guides on pages 14 and 15.
- **Sinker Weight** should preferably be kept to a minimum – just enough to have the desired effect.
- **PTFE Coated Sinkers** can be used where there may be a reaction between steel and the tablet. They also work well with magnetic retrievers.
- **Uncoated** type 316 stainless steel sinkers are more durable than coated sinkers.
- **Basket Sinkers** can be used but care should be taken that the outer coating of the tablet does not clog the mesh.
- **Wire Spirals** should be as wide as practically possible to avoid clogging which would affect the dissolution rate.

Basket Sinkers

Part No.	Description	OEM Ref
CUSBSK-JP	Japanese Pharmacopeia Basket Sinker (This has same dimensions as sinker shown in USP)	12-3070
BSK008-01	8 Mesh Basket Sinker	-
BSK008-JP	8 Mesh Basket Sinker, Japanese Pharmacopeia Size	-
SNK008-VK	8 Mesh Basket Sinker with Lid	12-3062
SNK010-VK	10 Mesh Basket Sinker with Lid	12-3060
SNK040-VK	40 Mesh Basket Sinker with Lid	12-3064

Pronged Sinkers

Part No.	Description	OEM Ref
CAPWHT-VK	3 Pronged Capsule Sinker	12-3050
MAGWHT-VK	3 Pronged Capsule Sinker with Magnetic Legs	12-3056
CAPWHT-SV	3 Pronged Capsule Sinker, 316 S.S.	-



O-Ring Sinkers

O-ring sinkers feature an expandable rubber ring. This lets the capsule swell whilst still maintaining adequate sinking.

Part No.	Description	OEM Ref
CAPWHT-S99	O-Ring Sinker, 316 S.S.	8399



= Sotax
 = VanKel

All Capsule Sinkers are shown at Actual Size



Spiral Sinkers

Part No.	Description	OEM Ref
CAPWHT-TR	Time Release Capsule Sinker	-
CAPWHT-PC	Breath Film Sinker	-
CAPWST-15	4 Spiral Sotax Style 316 S.S. Capsule Sinker	8280
CAPWHT-04	4 Spiral PTFE Coated Capsule Sinker	-
CAPWHT-4S	4 Spiral 316 S.S. Capsule Sinker	-
CAPWHT-LG	4 Spiral PTFE Coated Capsule Sinker	-
CAPWHT-XL	4 Spiral PTFE Coated Capsule Sinker	-
CAPWST-18	5 Spiral Sotax Style 316 S.S. Capsule Sinker	7346
CAPWST-19	6 Spiral Sotax Style 316 S.S. Capsule Sinker	8283
CAPWHT-2S	6 Spiral 316 S.S. Capsule Sinker	-
CAPWHT-02	6 Spiral PTFE Coated Capsule Sinker	-
CAPWHT-XS	6 Spiral 316 S.S. Capsule Sinker	-
CAPWST-23	7 Spiral Sotax Style 316 S.S. Capsule Sinker	6881
CAPWST-31	10 Spiral Sotax Style 316 S.S. Capsule Sinker	7349



CAPWHT-TR



CAPWHT-PC



CAPWST-15

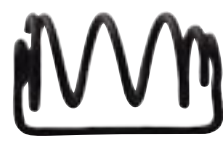

CAPWHT-04

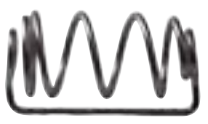

CAPWHT-4S

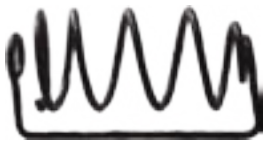

CAPWHT-LG

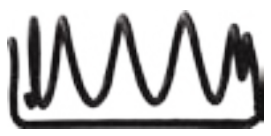

CAPWHT-XL

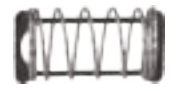

CAPWST-18



CAPWST-19

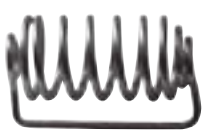

CAPWHT-2S



CAPWHT-02



CAPWHT-XS



CAPWST-23



CAPWST-31

All Capsule Sinkers are shown at Actual Size

Type 316 Stainless Steel Wire

This wire is ideal for winding your own tablet sinkers, especially if you have non-standard sized tablets. It is the same high-quality wire used to construct the LabHut basket sinkers and spiral sinkers and is very easy to work with.

Part No.	Description	OEM Ref
WIRESK-VK	316 Stainless Steel Wire, 0.024" (0.6mm) Diameter, 50' (15m) Roll	12-3000

Custom Sinkers

LabHut can supply custom sinkers to any specification. Please contact us with your requirements.

Part No.	Description	OEM Ref
CAPWHT-CUS	Custom weights & sinkers	-



Extensive details on all sinkers and capsules – SEE OVERLEAF



CAPSULE SINKERS

Sinker Type	Part Number	Style	Material	Coating	Inside Diameter	
					(inches)	(mm)
BASKET	CUSBSK-JP	Basket, JP	316 S.S.	-	0.470	11.9
	BSK008-01	Basket, 8 Mesh	316 S.S.	-	0.620	15.7
	BSK008-JP	Basket, 8 Mesh	316 S.S.	-	0.410	10.4
	SNK008-VK	Basket, 8 Mesh	316 S.S.	-	0.788	20.0
	SNK010-VK	Basket, 10 Mesh	316 S.S.	-	0.788	20.0
	SNK040-VK	Basket, 40 Mesh	316 S.S.	-	0.788	20.0
PRONGED	CAPWHT-VK	3 Prong	Nylon / P.P.	-	0.200	5.1
	MAGWHT-VK	3 Prong	Nylon / P.P.	-	0.200	5.1
	CAPWHT-SV	3 Prong	316 S.S.	-	0.275 → 0.210	7.0 → 5.3
O-RING	CAPWHT-S99	O-Ring	316 S.S.	-	0.466	11.8
SPIRAL	CAPWHT-TR	Butterfly	316 S.S.	-	0.224	5.7
	CAPWHT-PC	Strip Film	316 S.S.	-	0.436	11.0
	CAPWST-15	Helix	316 S.S.	-	0.197	5.0
	CAPWHT-04	Helix	Music Wire	PTFE	0.385	9.8
	CAPWHT-4S	Helix	316 S.S.	-	0.385	9.8
	CAPWHT-LG	Helix	Music Wire	PTFE	0.410	10.4
	CAPWHT-XL	Helix	Music Wire	PTFE	0.465	11.8
	CAPWST-18	Helix	316 S.S.	-	0.236	6.0
	CAPWST-19	Helix	316 S.S.	-	0.276	7.0
	CAPWHT-2S	Helix	316 S.S.	-	0.370	9.4
	CAPWHT-02	Helix	Music Wire	PTFE	0.370	9.4
	CAPWHT-XS	Helix	316 S.S.	-	0.580	14.7
	CAPWST-23	Helix	316 S.S.	-	0.315	8.0
	CAPWST-31	Helix	316 S.S.	-	0.433	11.0
WIRE	WIRESK-VK	Sinker Wire 50'	316 S.S.	-	-	-

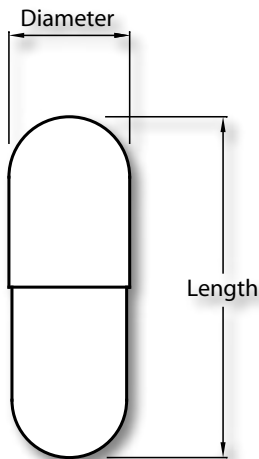

CAPSULES				
Capsule Size	Length		Diameter	
	(inches)	(mm)	(inches)	(mm)
000	1.029	26.1	0.390	9.91
00E	1.012	25.7	0.336	8.53
00	0.917	23.3	0.336	8.53
0E	0.909	23.1	0.301	7.65
0	0.854	21.7	0.301	7.65
1	0.765	19.4	0.272	6.91
2	0.709	18.0	0.250	6.35
3	0.626	15.9	0.229	5.83
4	0.563	14.3	0.209	5.32
5	0.437	11.1	0.193	4.91



Inside Length (inches) (mm)		Wire Diameter (inches) (mm)		Max Capsule Size	No. of Coils	Weight (g)
0.935	23.7	0.039	0.99	00	8	4.00
1.060	26.9	0.028	0.71	000	9	5.40
0.790	20.1	0.028	0.71	1	8	3.85
0.461	11.7	0.028	0.71	000	-	17.60
0.461	11.7	0.025	0.64	000	-	19.00
0.461	11.7	0.010	0.25	000	-	20.00
1.000	25.4	-	-	2	-	0.90
1.000	25.4	-	-	2	-	1.20
1.040	26.4	-	-	1 (min=3)	-	1.25
1.015	25.8	-	-	1	-	1.14
0.386	9.8	0.026	0.66	-	-	0.55
0.436	11.1	0.035	0.89	-	-	1.20
0.610	15.5	0.016	0.41	5	6	0.60
0.840	21.3	0.043	1.09	0	5	1.70
0.840	21.3	0.047	1.19	0	5	1.95
1.100	27.9	0.043	1.09	000	6.5	2.00
1.150	29.2	0.043	1.09	000	5.5	2.15
0.709	18.0	0.016	0.41	3	8.7	0.75
0.760	19.3	0.016	0.41	2	8	1.00
0.840	21.3	0.043	1.09	0	8.5	2.85
0.840	21.3	0.050	1.27	0	8.5	2.05
0.885	22.5	0.047	1.19	Special*	8.5	3.60
0.905	23.0	0.016	0.41	0	9	0.95
1.220	31.0	0.031	0.79	000	11.9	3.25
-	-	0.032	0.81	-	-	-

NEED ANY FURTHER
ADVICE ON SINKERS?
Email
sales@labhut.com

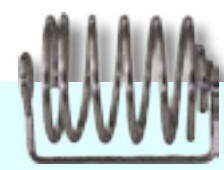

* The Maximum Capsule Size of CAPWHT-XS is described as "Special" because this sinker is often used in veterinary applications where the capsule diameter can be very large - this sinker has an inside diameter of 0.580" (14.7mm) to accommodate such capsules.

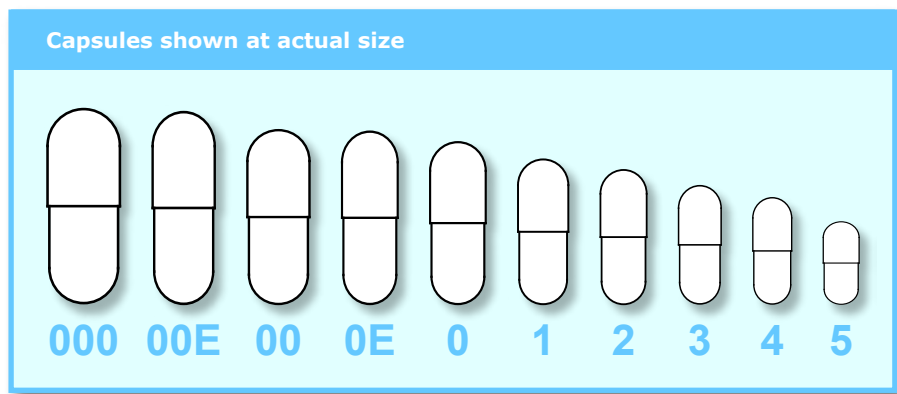



VESSELS



The Vessel



Good dissolution vessels are critical in obtaining correct and reproducible results and are sometimes overlooked as a key element in the dissolution test.

All vessels should meet the physical dimensions of the USP and have a hemispherical bottom which means that they should be perfectly rounded with no obvious join with the sides and no 'bumps' of glass on the inside. Wall thicknesses should be even and reproducible.

Although the USP states the dimensions for vessels, the tolerances are actually quite wide, meaning vessels associated with various dissolution baths are not dimensionally the same. Replacing a vessel with one not specifically designed for the instrument could impair vessel centering and paddle height. Also larger or smaller inside diameters can affect vessel hydrodynamics.

All LabHut vessels come complete with a certificate of compliance.

All vessels are U.S. Pharmacopeia compliant where applicable and meet machine manufacturer specifications

Care & Maintenance



Vessel Cleaning – It is important that vessels are clean prior to use – this is relevant when using capsules that have sticky coatings. This is necessary for two reasons – there may be contamination of the media which could lead to a high result or the tablet under test may stick to the vessel walls leading to a low result – this tends to show when using prednisone.

Any good laboratory detergent should work well to clean vessels. It can be used with hot water and a soft-bristled brush. Rinse with tap water (the hardness does a great job of removing soap residue) followed by a final rinse of purified water. It may also be necessary sometimes to use a towel wetted with methanol to remove really stubborn residues.

Vessel Storage – Vessels that are clipped or scratched should not be used. Small tablet particles can get stuck in the grooves. Severely scratched vessels can also affect the dynamics of the solution.

Proper storage in a vessel stand can prevent damage occurring. See vessel stands on page 18.

Key Considerations



Most baskets are graduated and all glass and plastic vessels are serialised for easy identification

Glass Vessels benefit from good thermal conductivity (it is often necessary to have the temperature of the water bath as much as 2°C higher than the analysis temperature when using plastic vessels).

Another advantage of using glass vessels is their high resistance to scratching, which means they have to be replaced less frequently.



Glass Vessel



Amber Vessel

Amber Vessels can be used if light sensitive compounds are being tested. They are available in glass and plastic.

Plastic Vessels can be used in place of glass where appropriate. The plastic must not interfere with the analysis by sorbing, leaching or reacting with the analyte. Typically styrene acrylonitrile is used.

Plastic vessels have the advantage over glass in that they are very reproducible – the vessel is made from a mould rather than hand-formed. This reduces possible errors in setting the paddle height and centering and can give very reproducible results.

Another advantage of plastic vessels is that they have feet so they can stand upright independently.

The biggest disadvantage is that plastic is very prone to scratching and cracking, requiring frequent replacement.



Plastic Vessel

Peak Vessels are designed to prevent cone formation at the base of the vessel.

An undesirable poorly stirred cone shaped region can develop under the paddle during USP Apparatus 2 dissolution tests. Peak vessels have a cone shape moulded into the bottom of the vessel that improves the hydrodynamics around the dosage form and leads to more reproducible dissolution rates.

The peak effectively displaces the unstirred cone, forcing the material tested into the region of appropriate hydrodynamics, where all surfaces of the dosage are constantly and uniformly exposed to the moving medium.

Peak vessels do not comply with USP specifications and cannot be substituted in existing applications.



Peak Vessel

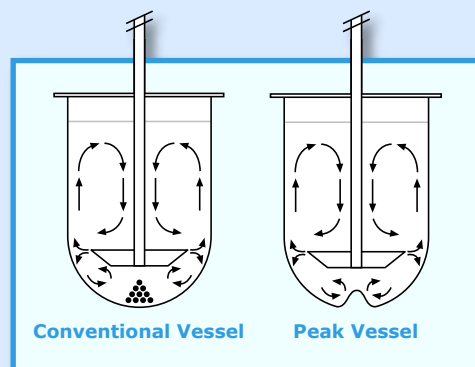

Conventional Vessel

Peak Vessel



Caleva Compatible Vessels

Part No.	Description	OEM Ref
GLA900-CA	1000ml Clear Glass Vessel	0810004
GLA900-AC	1000ml Amber Glass Vessel	0810009



GLA900-CA



GLA900-AC

Distek Compatible Vessels

Part No.	Description	OEM Ref
GLA200-DK	200ml Clear Glass Vessel	3010-0095
GLA500-DK	500ml Clear Glass Vessel	-
GLA900-DK	1000ml Clear Glass Vessel	3010-0069
GLA900-AD	1000ml Amber Glass Vessel	-
GLA9CR-DK	1000ml Clear Glass Vessel with Centering Ring	3010-0093
GLA9CR-AD	1000ml Amber Glass Vessel with Centering Ring	3010-0023
GLA9PK-DK	1000ml Clear Glass Peak Vessel	3010-0550
PLA900-DK	1000ml Clear Plastic Vessel	3350-0095
PLA900-AD	1000ml Amber Plastic Vessel	-
FLU9CL-DK	1000ml Clear Fluoropolymer Vessel	-
FLU900-DK	1000ml Opaque Fluoropolymer Vessel	-
GLA02K-DK	2000ml Clear Glass Vessel	3010-0285
RING01-DK	Plastic Centering Ring	3350-0096
VSCLIP-DK	Vessel Hold Down Clamp	2821-0257



GLA200-DK



GLA500-DK



GLA900-DK



GLA900-AD



GLA9CR-DK



GLA9CR-AD



RING01-DK



VSCLIP-DK



GLA9PK-DK



PLA900-DK



PLA900-AD



FLU9CL-DK



FLU900-DK



GLA02K-DK

Erweka Compatible Vessels

Part No.	Description	OEM Ref
GLA900-EW	1000ml Clear Glass Vessel	80-000-1002
GLA900-AW	1000ml Amber Glass Vessel	80-000-1004
PLA900-EW	1000ml Clear Plastic Vessel	-
GLA02K-EW	2000ml Clear Glass Vessel	80-000-2002



GLA900-EW



GLA900-AW



PLA900-EW



GLA02K-EW





Hanson Compatible Vessels

Part No.	Description	OEM Ref
GLA500-HR	500ml Clear Glass Vessel	-
GLA900-HR	1000ml Clear Glass Vessel	72-600-510
GLA900-AH	1000ml Amber Glass Vessel	72-600-556
GLA9PK-HR	1000ml Clear Glass Peak Vessel with Centering Ring	-
PLA900-HR	1000ml Clear Plastic Vessel	91-030-003
PLA900-AH	1000ml Amber Plastic Vessel	-
FLU9CL-HR	1000ml Clear Fluoropolymer Vessel	-
FLU900-HR	1000ml Opaque Fluoropolymer Vessel	-
GLA02K-HR	2000ml Clear Glass Vessel	72-600-509



Pharmatest Compatible Vessels

Part No.	Description	OEM Ref
GLA900-PT	1000ml Clear Glass Vessel	303-5225
GLA900-AT	1000ml Amber Glass Vessel	303-5425
PLA900-PT	1000ml Clear Plastic Vessel	-
PLA900-AP	1000ml Amber Plastic Vessel	-



Universal Vessel Stands

For the safe transportation and storage of vessels

Due to their shape, dissolution vessels are difficult to hold securely. This can often result in scratched, chipped or even smashed vessels.

The steel/acrylic stands are available in 6 or 8 vessel capacities and can hold vessels from any dissolution bath manufacturer.

They can also be stacked together to save bench space and enable you to transport many vessels at a time.



Part No.	Description	OEM Ref
VESSTD-06A	Vessel Stand, 6 Position	-
VESSTD-08A	Vessel Stand, 8 Position	-



Sotax Compatible Vessels

Part No.	Description	OEM Ref
GLA900-ST	1000ml Clear Glass Vessel	2503
GLA900-AS	1000ml Amber Glass Vessel	2503-2



GLA900-ST

VanKel Compatible Vessels

Part No.	Description	OEM Ref
GLA100-VK	100ml Clear Glass Vessel	12-5040
GLA200-VK	200ml Clear Glass Vessel	12-5050
GLA500-01	500ml Clear Glass Vessel	12-5060
GLA900-01	1000ml Clear Glass Vessel	12-5000
GLA900-AV	1000ml Amber Glass Vessel	12-5010
GLA9PK-01	1000ml Clear Glass Peak Vessel	12-5500
GLA9PK-VK	1000ml Clear TruCenter Glass Peak Vessel for V-Series Baths	12-5125
GLA900-VK	1000ml Clear TruCenter Glass Vessel for V-Series Baths	12-5035
GLA9AM-VK	1000ml Amber TruCenter Glass Vessel for V-Series Baths	12-5020
PLA900-01	1000ml Clear Plastic Vessel	12-5200
PLA900-AV	1000ml Amber Plastic Vessel	-
FLU9CL-01	1000ml Clear Fluoropolymer Vessel	-
FLU900-01	1000ml Opaque Fluoropolymer Vessel	-
GLA02K-01	2000ml Clear Glass Vessel	12-5070



GLA100-VK

GLA200-VK

GLA500-01

GLA900-01



GLA900-AV

GLA9PK-01

GLA9PK-VK

GLA900-VK



GLA9AM-VK

PLA900-01

PLA900-AV

FLU9CL-01

Experiencing Vessel Centering Brackets with Broken "Pins"?

Original equipment centering brackets often encounter one or more broken centering pins. This results in unbalanced centering, which can easily exceed USP (711) specifications.

The centering pins on **EZLBKT-01** are more robust to begin with and are easily replaceable if broken with **EZLKIT-01**.



EZLBKT-01

EZLKIT-01

V600A-CR

EZLPEG-01



FLU900-01

GLA02K-VK



VESSEL COVERS



The Cover



The loss of media due to evaporation and condensation can be considerable. Vessel Covers should reduce these problems and provide openings to accommodate cannulae and stoppers.

Cover styles include all common one-piece and hinged covers, as well as a unique rotary configuration.

Industry standard openings are provided to accommodate standard cannulae and stoppers.

Key Considerations



Evaporation Losses are reduced by using vessel covers with a minimal open area during the test. Slots and holes for temperature verification, sample introduction and sample collection should be closed when not in use.

Cannula Stoppers – Cannulae can be used with stoppers during manual sampling to ensure that the sample is always taken from the same depth.

Vessel covers must have the appropriate hole for the stopper (which is attached to the cannula) to sit in.

The stopper and cannula must match the vessel cover type or manufacturer.

See page 26 for sampling cannulae and stoppers.

Distek Compatible Vessel Covers

Part No.	Description	OEM Ref
COVERD-00	Low Evaporation Rotary Cover, 0.53" (13.5mm) Cannula Hole Diameter	-
COVERD-01	Clear Hinged Cover, 0.53" (13.5mm) Cannula Hole Diameter	3250-0089
COVERD-02	Amber Hinged Cover, 0.53" (13.5mm) Cannula Hole Diameter	-
COVERD-BK	Clear Hinged Cover with Large Centre Hole for Easy Basket Access, 0.53" (13.5mm) Cannula Hole Diameter	3250-0070
COVERAD-BK	Amber Hinged Cover with Large Centre Hole for Easy Basket Access, 0.53" (13.5mm) Cannula Hole Diameter	-
COVERD-HG	Clear Low Evaporation Hinged Cover, 0.53" (13.5mm) Cannula Hole Diameter	-
COVDHG-SB	Clear Stationary Basket Apparatus Hinged Cover	3250-0081
COVPLG-7D	7th Position Cover Plug	3350-0109
COVPLG-DK	Probe Hole Plug	5720-4037
COVCAP-DK	Clear Cap for Basket Access Cover	3250-0019
COVCAP-AD	Amber Cap for Basket Access Cover	-
HINGE-DK	Plastic Hinge	5560-6011

VanKel Compatible Vessel Covers

Part No.	Description	OEM Ref
COVERV-00	Low Evaporation Rotary Cover, 0.31" (7.9mm) Cannula Hole Diameter	-
COVERV-01	Clear Cover with Paddle Slot, 0.31" (7.9mm) Cannula Hole Diameter	12-6300
COVERV-02	Amber Cover with Paddle Slot, 0.31" (7.9mm) Cannula Hole Diameter	12-6320
COVERV-03	Clear Solid Cover	12-6330
COVERV-04	Clear Evaporation Cover for Dosage Delivery Module, 0.31" (7.9mm) Cannula Hole Diameter	12-6310
COVERV-HG	Clear Low Evaporation Hinged Cover, 0.31" (7.9mm) Cannula Hole Diameter	-
COVERV-LL	Low Loss Evaporation Cover, Conical Shape, 0.78" (19.8mm) Cannula Hole Diameter	12-0469
COVERV-LLHG	Low Loss Evaporation Hinged Cover, Conical Shape, 0.78" (19.8mm) Cannula Hole Diameter	12-6328
COVERV-LLSB	Stationary Basket Apparatus Low Loss Evaporation Hinged Cover, Conical Shape	-
COVERV-LLVS	TruCenter Low Loss Evaporation Hinged Cover, Conical Shape, 0.78" (19.8mm) Cannula Hole Diameter	12-6327
COVHGV-SB	Clear Stationary Basket Apparatus Hinged Cover	-
COVERV-6K	Clear Evaporation Cover for VK600/VK6000 Series, 0.31" (7.9mm) Cannula Hole Diameter	12-6200

Hanson Compatible Vessel Covers

Part No.	Description	OEM Ref
COVERH-00	Low Evaporation Rotary Cover, 0.53" (13.5mm) Cannula Hole Diameter	65-233-170
COVERH-01	Clear Cover with Paddle Slot	72-500-215
COVERH-02	Grey Cover with Paddle Slot	72-800-603
COVERH-03	Amber Cover with Paddle Slot	-
COVERH-04	Clear Solid Cover	-
COVERH-HG	Clear Low Evaporation Hinged Cover, 0.53" (13.5mm) Cannula Hole Diameter	95-590-046
COVERH-LL	Low Loss Evaporation Cover, Conical Shape	-





COVERD-00



COVERD-01



COVERD-02



COVERD-BK



COVERAD-BK



COVERD-HG



COVDHG-SB



COVPLG-7D



COVPLG-DK



COVCAP-DK



HINGE-DK



COVERH-00



COVERH-01



COVERH-02



COVERH-03

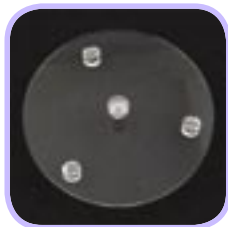

COVERH-04



COVERH-HG



COVERH-LL



COVERV-00



COVERV-01



COVERV-02



COVERV-03



COVERV-04

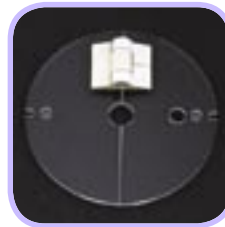

COVERV-HG



COVERV-LL



COVERV-LLHG



COVERV-LLVS



COVERV-6K



FILTERS

The Filter



Almost every dissolution test relies on samples being taken to produce a result. Filters are used to prevent particles of tablet from getting into the sample and affecting the spectrophotometer or HPLC results.

Filters should be shown not to adsorb any compounds of interest.

All filters are U.S. Pharmacopeia compliant where applicable and meet machine manufacturer specifications

Key Considerations



Most manufacturers use a filter on the end of the sampling cannula. These **cannula filters** are made of UHMW Polyethylene for larger porosities or Poroplast for lower porosities (1-5µm) and are completely inert to most compounds.

With filters, **porosities** are nominal and represent an average pore size rather than an absolute pore size. Thus a 35µm and 40µm filter will perform in much the same way.

If in-line filters are used it is important that a small amount of media is **pushed back** in the reverse direction to wash particles off the filter back into the vessel. Particles are part of the tablet and as such should be kept inside the vessel dissolving with the rest of the tablet.

Failure to do this results in the particles staying on the filter. The effect of this is not only to remove the particles from the media but next time a sample is taken, the media is pulled through the particles stuck to the filter which can give erroneously high readings.

When selecting a filter, it is wise to conduct some tests to ensure that there is no **sample absorption** onto the filter. If this is a problem then alternative filters and materials are available but external filtration may be required.



Cannula Filters
(see all manufacturers, pages 23-25)



Cannula Filters, VanKel Style
(see VanKel, page 25)



Filter Discs
(see Distek, page 23)



Filter Tips
(see VanKel, page 25)

Types of filter:

Cannula Filters

Cannula Filters generally have a large surface area and may affect the hydrodynamics in the vessel. However they have a good flow rate and may be used when high levels of particulates are present to prevent particulates blocking the sample probes. A large porosity range is available. Different manufacturers recommend different filters for use with their sample probes and not all are interchangeable because of differences in probe diameter.

Filter Discs

Some low volume sample probes require an In-Line Filter Disc (or filter frit) which has a lower surface area than a cannula filter. These are designed to keep the filtration process outside the vessel but may suffer from blocking due to the lower surface area.

This problem can be solved with the Hi-Cap cannula which uses standard cannula filters outside the vessel. See page 30.

Filter Tips

Filter Tips are smaller than cannula filters and fit on the end of larger diameter sample probes.

For EXPERT ADVICE on obtaining the correct filter for your cannula email sales@labhut.com



Caleva Compatible Cannula Filters

Caleva tablet dissolution baths normally use cannula style filters with a large range of porosities.

Part No.	Description	Quantity	OEM Ref
FIL001-CA-100 FIL001-CA-1000	1µm Cannula Filters, Poroplast	100 Pack 1000 Case	0810100 0810101
FIL004-CA-100 FIL004-CA-1000	4µm Cannula Filters, Poroplast	100 Pack 1000 Case	0810103 0810104
FIL010-CA-100 FIL010-CA-1000	10µm Cannula Filters, UHMW Polyethylene	100 Pack 1000 Case	0810106 0810107
FIL035-CA-100 FIL035-CA-1000	35µm Cannula Filters, UHMW Polyethylene	100 Pack 1000 Case	0810142 0810143
FIL040-CA-100 FIL040-CA-1000	40µm Cannula Filters, UHMW Polyethylene	100 Pack 1000 Case	0810097 0810098
FIL070-CA-100 FIL070-CA-1000	70µm Cannula Filters, UHMW Polyethylene	100 Pack 1000 Case	- -



Caleva Cannula Filter

Distek Compatible Filter Discs and Cannula Filters

Distek tablet dissolution baths utilise a **narrow sample probe** that incorporates a **small filter disc** at the top. As these small filters can become blocked, an **external filter at the end of the sample probe** may be used instead of, or in addition to the filter disc.

Part No.	Description	Quantity	OEM Ref
FIL010-DK	10µm Filter Discs, UHMW Polyethylene	1000 Case	5720-0203
FIL045-DK	45µm Filter Discs, UHMW Polyethylene	1000 Case	5720-0275
FIL070-DK	70µm Filter Discs, UHMW Polyethylene	1000 Case	-
FIL090-DK	90µm Filter Discs, UHMW Polyethylene	1000 Case	-
FIL10S-DK-100 FIL10S-DK-1000	10µm Cannula Filters, 1/16" (1.6mm) ID, UHMW Polyethylene	100 Pack 1000 Case	5720-0500 5720-0501
FIL20S-DK-100 FIL20S-DK-1000	20µm Cannula Filters, 1/16" (1.6mm) ID, UHMW Polyethylene	100 Pack 1000 Case	- -
FIL35S-DK-100 FIL35S-DK-1000	35µm Cannula Filters, 1/16" (1.6mm) ID, UHMW Polyethylene	100 Pack 1000 Case	5720-0220-100 5720-0220-1000
FIL45S-DK-100 FIL45S-DK-1000	45µm Cannula Filters, 1/16" (1.6mm) ID, UHMW Polyethylene	100 Pack 1000 Case	5720-0020-100 5720-0020-1000
FIL70S-DK-100 FIL70S-DK-1000	70µm Cannula Filters, 1/16" (1.6mm) ID, UHMW Polyethylene	100 Pack 1000 Case	5720-0502 5720-0503



Distek Filter Disc



Distek Cannula Filter

Erweka Compatible Cannula Filters

Erweka tablet dissolution baths normally use cannula style filters with a large range of porosities.

Part No.	Description	Quantity	OEM Ref
FIL001-EW-100 FIL001-EW-1000	1µm Cannula Filters, Poroplast	100 Pack 1000 Case	90-000-0013 90-000-0013
FIL004-EW-100 FIL004-EW-1000	4µm Cannula Filters, Poroplast	100 Pack 1000 Case	90-000-0023 90-000-0023
FIL010-EW-100 FIL010-EW-1000	10µm Cannula Filters, UHMW Polyethylene	100 Pack 1000 Case	90-000-0033 90-000-0033
FIL020-EW-100 FIL020-EW-1000	20µm Cannula Filters, UHMW Polyethylene	100 Pack 1000 Case	- -
FIL035-EW-100 FIL035-EW-1000	35µm Cannula Filters, UHMW Polyethylene	100 Pack 1000 Case	- -
FIL040-EW-100 FIL040-EW-1000	40µm Cannula Filters, UHMW Polyethylene	100 Pack 1000 Case	- -
FIL070-EW-100 FIL070-EW-1000	70µm Cannula Filters, UHMW Polyethylene	100 Pack 1000 Case	- -



Erweka Cannula Filter



FILTERS



Hanson Compatible Cannula Filters

Hanson Research dissolution baths normally use cannula style filters. The Hanson/Waters Dissolution/HPLC Interface uses a narrow bore (1/16" ID) filter instead of the normal cannula diameter. Both types are supplied, as listed below.

Part No.	Description	Quantity	OEM Ref
FIL001-HR-100 FIL001-HR-1000	1µm Cannula Filters, Poroplast	100 Pack 1000 Case	27-101-087 27-101-097
FIL004-HR-100 FIL004-HR-1000	4µm Cannula Filters, Poroplast	100 Pack 1000 Case	27-101-088 27-101-098
FIL010-HR-100 FIL010-HR-1000	10µm Cannula Filters, UHMW Polyethylene	100 Pack 1000 Case	27-101-074 27-101-091
FIL020-HR-100 FIL020-HR-1000	20µm Cannula Filters, UHMW Polyethylene	100 Pack 1000 Case	- -
FIL035-HR-100 FIL035-HR-1000	35µm Cannula Filters, UHMW Polyethylene	100 Pack 1000 Case	27-101-085 27-101-095
FIL045-HR-100 FIL045-HR-1000	45µm Cannula Filters, UHMW Polyethylene	100 Pack 1000 Case	27-101-089 -
FIL070-HR-100 FIL070-HR-1000	70µm Cannula Filters, UHMW Polyethylene	100 Pack 1000 Case	27-101-082 27-101-092
FIL10S-HR-100 FIL10S-HR-1000	10µm Cannula Filters, 1/16" (1.6mm) ID, UHMW Polyethylene	100 Pack 1000 Case	27-101-083 27-101-093
FIL35S-HR-100 FIL35S-HR-1000	35µm Cannula Filters, 1/16" (1.6mm) ID, UHMW Polyethylene	100 Pack 1000 Case	27-101-086 27-101-096
FIL45S-HR-100 FIL45S-HR-1000	45µm Cannula Filters, 1/16" (1.6mm) ID, UHMW Polyethylene	100 Pack 1000 Case	27-101-090 -
FIL70S-HR-100 FIL70S-HR-1000	70µm Cannula Filters, 1/16" (1.6mm) ID, UHMW Polyethylene	100 Pack 1000 Case	27-101-084 27-101-094



FIL010-HR-100/1000



FIL070-HR-100/1000



FIL10S-HR-100/1000

Cannula Filter Colour Coding

Cannula filters are colour coded for easy identification of porosity.



Pharmatest Compatible Cannula Filters

Pharmatest dissolution baths normally use cannula style filters.

Part No.	Description	Quantity	OEM Ref
FIL001-PT-100 FIL001-PT-1000	1µm Cannula Filters, Poroplast	100 Pack 1000 Case	- -
FIL004-PT-100 FIL004-PT-1000	4µm Cannula Filters, Poroplast	100 Pack 1000 Case	- -
FIL005-PT-100 FIL005-PT-1000	5µm Cannula Filters, UHMW Polyethylene	100 Pack 1000 Case	31-63511-50 -
FIL010-PT-100 FIL010-PT-1000	10µm Cannula Filters, UHMW Polyethylene	100 Pack 1000 Case	- -
FIL035-PT-100 FIL035-PT-1000	35µm Cannula Filters, UHMW Polyethylene	100 Pack 1000 Case	- 31-63211-50
FIL070-PT-100 FIL070-PT-1000	70µm Cannula Filters, UHMW Polyethylene	100 Pack 1000 Case	- -



Pharmatest Cannula Filter



Sotax Compatible Cannula Filters

Sotax dissolution baths use a closed design. For manual and automatic sampling it is necessary to mount the sampling cannula through the drive head of the bath. This allows the use of cannula filters.

Part No.	Description	Quantity	OEM Ref
FIL010-SX-100	10µm Cannula Filters, UHMW Polyethylene	100 Pack	-
FIL010-SX-1000		1000 Case	-
FIL035-SX-100	35µm Cannula Filters, UHMW Polyethylene	100 Pack	-
FIL035-SX-1000		1000 Case	-
FIL070-SX-100	70µm Cannula Filters, UHMW Polyethylene	100 Pack	-
FIL070-SX-1000		1000 Case	-



Sotax Cannula Filter

VanKel Compatible Cannula Filters and Filter Tips

VanKel baths normally use either cannula style filters or filter tips. The filter tips fit on the end of larger diameter sample probes.

Part No.	Description	Quantity	OEM Ref
FIL010-01-100	10µm Cannula Filters, UHMW Polyethylene	100 Pack	17-4000
FIL010-01-1000		1000 Case	17-4000
FIL010-VK-100	10µm Direct Fit Cannula Filters (no Tygon tubing needed), UHMW Polyethylene	100 Pack	-
FIL010-VK-1000		1000 Case	-
FIL020-01-100	20µm Cannula Filters, UHMW Polyethylene	100 Pack	-
FIL020-01-1000		1000 Case	-
FIL035-01-100	35µm Cannula Filters, UHMW Polyethylene	100 Pack	17-4010
FIL035-01-1000		1000 Case	17-4010
FIL035-VK-100	35µm Direct Fit Cannula Filters (no Tygon tubing needed), UHMW Polyethylene	100 Pack	-
FIL035-VK-1000		1000 Case	-
FIL045-01-100	45µm Cannula Filters, UHMW Polyethylene	100 Pack	-
FIL045-01-1000		1000 Case	-
FIL070-01-100	70µm Cannula Filters, UHMW Polyethylene	100 Pack	17-4020
FIL070-01-1000		1000 Case	17-4020
FIL070-VK-100	70µm Direct Fit Cannula Filters (no Tygon tubing needed), UHMW Polyethylene	100 Pack	-
FIL070-VK-1000		1000 Case	-
FILTIP-02	2µm Filter Tips	1000 Case	17-4100
FILTIP-05	5µm Filter Tips	1000 Case	17-4110
FILTIP-10	10µm Filter Tips	1000 Case	17-4120
FILTIP-20	20µm Filter Tips	1000 Case	17-4130
FILTIP-45	45µm Filter Tips	1000 Case	17-4140



VanKel Filter Tip



FIL010-01-100/1000



FIL020-01-100/1000



FIL035-01-100/1000



FIL070-01-100/1000

Tygon Tubing Troubles? Go for a Direct Fit!

The VanKel series of Direct Fit Cannula Filters have been designed to fit directly onto the end of the standard VanKel (Varian) style manual and automated cannula. No Tygon tubing needed!



SAMPLING CANNULAE

The Cannula



Almost every dissolution test relies on samples being taken to produce a result. It is important that the sampling method does not adversely affect the accuracy of the dissolution test. Sampling errors are very common and are often the cause of erroneous results. The sampling position is critical but so too is the type of sampling cannula (also known as a probe) used.

The USP defines the sampling point as:

"A zone half way between the top of the media and top of the paddle or basket not less than 1cm from the vessel wall."

Key Considerations



Sampling Position – The sampling position is important particularly for tests with baskets as there can be a concentration profile between the bottom of the vessel and the stirring element. It is less noticeable with paddles as the extra agitation provides for a more uniform flow profile.

The sampling position is different for 500ml and 900ml tests. This can create problems for equipment that uses 'through the shaft' sampling.

Cannula Length – Cannulae vary in length from 4.75" (120mm) to 15" (380mm). These extended lengths are normally used for "through the head sampling" whereby the cannula passes through the drive head of the dissolution bath.

Cannula Material – The cannulae are made from either stainless steel or PEEK so that they do not adsorb or interfere with the active ingredient.

Stoppers – Cannulae can be used with stoppers during manual sampling to ensure that the sample is always taken from the same depth. Stoppers are attached to the cannulae and sit in a hole in the vessel cover. If these are to be used then it is important to get the stopper and cannula to match the vessel cover type or manufacturer.

The range of self-tightening stoppers can be installed and positioned without the need for tools such as screwdrivers or spanners. See below for more details.

Selecting a Self-Tightening Cannula Stopper

Self-tightening cannula stoppers offer a convenient method of setting the cannula sampling position in accordance with USP 711.



Adjustable cannula stoppers are available for Distek, Hanson and VanKel cannulae.

Since there are numerous configurations of cannulae and dissolution instruments in common use, the specific application should be reviewed to ensure correct stopper selection.

The two factors which determine the specific stopper choice are:

- 1) Cannula outside diameter
- 2) Stopper outside diameter

The part numbering system incorporates both cannula and stopper outside diameters.

Part Numbering System:

CANSTP - 065 - 53
Cannula OD ———— | ———— Stopper OD

CANNULA OD	
Inches	Manufacturer
.065 (1/16")	Distek/Hanson
.078	VanKel
.125 (1/8")	Hanson
.142	VanKel

STOPPER OD	
Inches	Manufacturer
.31	VanKel
.44	Hanson/Waters
.53	Distek

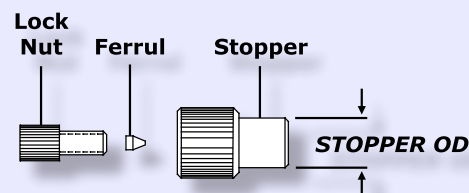
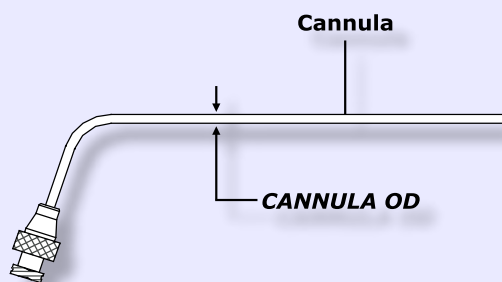

Stopper Configurations: Common configurations are listed with the appropriate cannulae. Configurations not listed are available by special order. Email sales@labhut.com or call +44 (0)1452 310210.



Caleva Compatible Sampling Cannulae

Part No.	Description	OEM Ref
CAN475-SC	120mm (4.75") Bent Stainless Steel Cannula with Luer Adapter, for 900ml Manual Sampling	-
CAN775-SC	195mm (7.75") Bent Stainless Steel Cannula with Luer Adapter, for 500ml Manual Sampling	-
CAN475-PC	120mm (4.75") Bent PEEK Cannula with Luer Adapter, for 900ml Manual Sampling	-
CAN775-PC	195mm (7.75") Bent PEEK Cannula with Luer Adapter, for 500ml Manual Sampling	-
CANSTP-CA	Adjustable Cannula Stopper	-



Distek Compatible Sampling Cannulae

Part No.	Description	OEM Ref
CAN500-DK	500ml Sampling Probe	2910-0500
CAN900-DK	900ml Sampling Probe	2910-0900
CAN01K-DK	1000ml Sampling Probe	2910-1000
CAN5PK-DK16	500ml PEEK Sampling Probe, 1/16" (1.6mm) OD	-
CAN9PK-DK8	900ml PEEK Sampling Probe, 1/8" (3.2mm) OD	-
CANRET-DK	Return Probe	2910-0001
CANSTP-065-53	Distek/Hanson 1/16" (1.6mm) Self-Tightening Cannula Stopper for Distek Covers	-
FILASY-DK	Inline Filter Housing Assembly for Distek Style Filters	-
LE87-6	Male Luer to Female Luer, Thread Style Elbow	5720-9074
SFTL-6	Female Luer Lug Style with 5/16" Hex to 1/4-28 UNF Thread	5720-9059
SMTLL-6	Male Luer Integral Lock Ring to 1/4-28 UNF Thread	5720-9060



Filters for all Cannulae – See pages 22-25





SAMPLING CANNULAE

Erweka Compatible Sampling Cannulae

Part No.	Description	OEM Ref
CAN475-SH	120mm (4.75") Bent Stainless Steel Cannula with Luer Adapter, for 900ml Manual Sampling	-
CAN775-SH	195mm (7.75") Bent Stainless Steel Cannula with Luer Adapter, for 500ml Manual Sampling	-
CAN015-SH	380mm (15") Bent Stainless Steel Cannula with Luer Adapter, Through Head Mount	-
CAN475-PH	120mm (4.75") Bent PEEK Cannula with Luer Adapter, for 900ml Manual Sampling	-
CAN775-PH	195mm (7.75") Bent PEEK Cannula with Luer Adapter, for 500ml Manual Sampling	-
CAN015-PH	380mm (15") Bent PEEK Cannula with Luer Adapter, Through Head Mount	-
CANSTP-EW	Adjustable Cannula Stopper	-



Hanson Compatible Sampling Cannulae

Part No.	Description	OEM Ref
CAN475-HR	4.75" (120mm) Bent Stainless Steel Cannula with Luer Adapter and Permanent Tip	-
CAN775-HR	7.75" (195mm) Bent Stainless Steel Cannula with Luer Adapter and Permanent Tip	-
CAN015-HR	15" (380mm) Bent Stainless Steel Cannula, 1/8" (3.2mm) OD, 0.085" (2.2mm) ID	72-300-304
CAN475-SH	4.75" (120mm) Bent Stainless Steel Cannula with Luer Adapter, for 900ml Manual Sampling, 1/8" (3.2mm) OD	95-590-002
CAN775-SH	7.75" (195mm) Bent Stainless Steel Cannula with Luer Adapter, for 500ml Manual Sampling, 1/8" (3.2mm) OD	95-590-001
CAN015-SH	15" (380mm) Bent Stainless Steel Cannula with Luer Adapter, Through Head Mount, 1/8" (3.2mm) OD	95-590-003
CANS15-SH	15" (380mm) Straight Stainless Steel Cannula with Luer Adapter, Through Head Mount, 1/8" (3.2mm) OD	-
CAN475-PH	4.75" (120mm) Bent PEEK Cannula with Luer Adapter, for 900ml Manual Sampling, 1/8" (3.2mm) OD	95-590-005
CAN775-PH	7.75" (195mm) Bent PEEK Cannula with Luer Adapter, for 500ml Manual Sampling, 1/8" (3.2mm) OD	95-590-004
CAN015-PH	15" (380mm) Bent PEEK Cannula with Luer Adapter, Through Head Mount, 1/8" (3.2mm) OD	95-590-006
CANS15-PH	15" (380mm) Straight PEEK Cannula with Luer Adapter, 1/8" (3.2mm) OD	-
CANSTP-065-53	Distek/Hanson 1/16" (1.6mm) Self-Tightening Cannula Stopper for Distek Covers	-
CANSTP-125-31	Hanson 1/8" (3.2mm) OD Self-Tightening Cannula Stopper for VanKel Covers	-
CANSTP-125-53	Hanson 1/8" (3.2mm) OD Self-Tightening Cannula Stopper for Distek Covers	-
TUMSCR-HR	Adjustable Cannula Stopper (for use with all 15" (380mm) cannulae)	-





Pharmatest Compatible Sampling Cannulae

Part No.	Description	OEM Ref
CAN475-SP	120mm (4.75") Bent Stainless Steel Cannula with Luer Adapter, for 900ml Manual Sampling	-
CAN775-SP	195mm (7.75") Bent Stainless Steel Cannula with Luer Adapter, for 500ml Manual Sampling	-
CAN475-PP	120mm (4.75") Bent PEEK Cannula with Luer Adapter, for 900ml Manual Sampling	-
CAN775-PP	195mm (7.75") Bent PEEK Cannula with Luer Adapter, for 500ml Manual Sampling	-
CANSTP-PT	Adjustable Cannula Stopper	-



NEED HELP selecting the correct cannula for your application?
Email sales@labhut.com

Sotax Compatible Sampling Cannulae

Part No.	Description	OEM Ref
CAN013-ST	330mm (13") Bent Stainless Steel Cannula with Luer Adapter, Through Head Mount	-
CAN013-ST-5	330mm (13") Stainless Steel Cannula, Including Stopper and Sleeve, for 500ml Sampling	-
CAN013-ST-9	330mm (13") Stainless Steel Cannula, Including Stopper and Sleeve, for 900ml Sampling	-
PRBFSR-ST	Combined Sample/Return Cannula with Filter Housing	-
PRBNSR-ST	Combined Sample/Return Cannula without Filter Housing	-
PRBFSR-5S	500ml Sample/Return Probe Fixed with Filter Housing, Stopper & Up/Down Collars	-
PRBFSR-9S	900ml Sample/Return Probe Fixed with Filter Housing, Stopper & Up/Down Collars	-
CANSTP-ST	Adjustable Cannula Stopper (for use with CAN013-ST)	-
CADSTP-ST	Validation Stopper (two holes for manual and auto cannulae)	-





VanKel Compatible Sampling Cannulae

Part No.	Description	OEM Ref
CAN475-01	4.75" (120mm) bent SS cannula with luer adapter, for 900ml sampling, 0.083" (2.1mm) OD	12-3200
CAN775-01	7.75" (195mm) bent SS cannula with luer adapter, for 500ml sampling, 0.083" (2.1mm) OD	12-3210
CA8475-VK	4.75" (120mm) bent SS cannula with luer adapter, for 900ml sampling, 1/8" (3.2mm) OD	-
CA8775-VK	7.75" (195mm) bent SS cannula with luer adapter, for 500ml sampling, 1/8" (3.2mm) OD	-
CA8015-VK	15" (380mm) bent SS cannula with luer adapter, through head mount, 1/8" (3.2mm) OD	-
CA8475-PV	4.75" (120mm) bent PEEK cannula with luer adapter, for 900ml sampling, 1/8" (3.2mm) OD	-
CA8775-PV	7.75" (195mm) bent PEEK cannula with luer adapter, for 500ml sampling, 1/8" (3.2mm) OD	-
CA8015-PV	15" (380mm) bent PEEK cannula with luer adapter, through head mount, 1/8" (3.2mm) OD	-
CANRET-25	2.5" (65mm) Autosampling Return Cannula	17-3320
CAN900-45	4.5" (115mm) Autosampling Cannula	17-3300
CAN500-60	6.5" (165mm) Autosampling Cannula	17-3305
PROBEX-VK	500ml Cannula Extension Kit	17-3306
CANSTP-078-31	VanKel Standard Self-Tightening Cannula Stopper for VanKel Covers	-
CANSTP-142-31	VanKel 1/8" (3.2mm) OD Self-Tightening Cannula Stopper for VanKel Covers	-



Filters for all Cannulae – See pages 22-25





Disposable Sampling Cannulae

No more cleaning or cross-contamination

Key Features:



- Made from high quality stainless steel
- Compatible with all open dissolution baths
- Use standard cannula filters
- Luer connection for easy fixing to syringes
- No cleaning required, saving time and expense
- Eliminates the chance of sample cross contamination
- Very low cost compared to standard steel cannulae

Traditional sampling cannulae require care, effective cleaning and can be expensive. The disposable cannulae are **thrown away after use** meaning **no cleaning** is required and cross-contamination is eliminated.

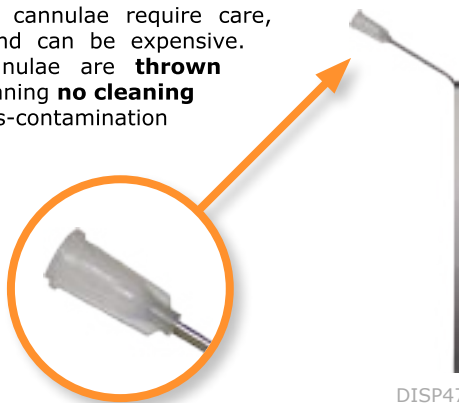

DISP475-HR

Cannula Assembly

Part No.	Description	Quantity	OEM Ref
DISP475-HR	Disposable Sampling Cannula, 900ml	30 Pack	-
DISPCAN-CUST	Disposable Sampling Cannula, Custom Size	Any	-

Hanson Compatible Cannula Filters (See page 24)

Part No.	Description	Quantity	OEM Ref
FIL10S-HR-100	10µm Cannula Filters, 1/16" (1.6mm) ID	100 Pack	27-101-083
FIL10S-HR-1000	10µm Cannula Filters, 1/16" (1.6mm) ID	1000 Case	27-101-093
FIL35S-HR-100	35µm Cannula Filters, 1/16" (1.6mm) ID	100 Pack	27-101-086
FIL35S-HR-1000	35µm Cannula Filters, 1/16" (1.6mm) ID	1000 Case	27-101-096
FIL45S-HR-100	45µm Cannula Filters, 1/16" (1.6mm) ID	100 Pack	27-101-090
FIL45S-HR-1000	45µm Cannula Filters, 1/16" (1.6mm) ID	1000 Case	-
FIL70S-HR-100	70µm Cannula Filters, 1/16" (1.6mm) ID	100 Pack	27-101-084
FIL70S-HR-1000	70µm Cannula Filters, 1/16" (1.6mm) ID	1000 Case	27-101-094

Hi-Cap High Capacity Sampling Cannulae

Increased capacity for most brands of dissolution bath

Available for 500ml, 900ml and 1000ml tests, this new style sampling probe has an inert twist-lock housing which safely contains a standard VanKel cannula filter. This means that the same cannula filters can be used for different dissolution baths, offering increased flexibility.

The surface area of the VanKel cannula filter is greater than 7 times that of the small filter disc that is traditionally used in this style of sample probe.

The Hi-Cap's thin low-volume stainless steel cannula can remain in the vessel throughout the dissolution test without affecting the dissolution result, removing the need for an automated probe lift. The cannula simply sits in the vessel cover and samples from the same position every time.

Cannula Assembly

Part No.	Description	OEM Ref
CAN500-DV	Hi-Cap High capacity sampling cannula for most dissolution baths, 500ml	-
CAN900-DV	Hi-Cap High capacity sampling cannula for most dissolution baths, 900ml	-
CAN01K-DV	Hi-Cap High capacity sampling cannula for most dissolution baths, 1000ml	-

VanKel Compatible Cannula Filters (See page 25)

Part No.	Description	Quantity	OEM Ref
FIL010-01-100	10µm Cannula Filters, UHMW Polyethylene	100 Pack	17-4000
FIL010-01-1000	10µm Cannula Filters, UHMW Polyethylene	1000 Case	17-4000
FIL020-01-100	20µm Cannula Filters, UHMW Polyethylene	100 Pack	-
FIL020-01-1000	20µm Cannula Filters, UHMW Polyethylene	1000 Case	-
FIL035-01-100	35µm Cannula Filters, UHMW Polyethylene	100 Pack	17-4010
FIL035-01-1000	35µm Cannula Filters, UHMW Polyethylene	1000 Case	17-4010
FIL045-01-100	45µm Cannula Filters, UHMW Polyethylene	100 Pack	-
FIL045-01-1000	45µm Cannula Filters, UHMW Polyethylene	1000 Case	-
FIL070-01-100	70µm Cannula Filters, UHMW Polyethylene	100 Pack	17-4020
FIL070-01-1000	70µm Cannula Filters, UHMW Polyethylene	1000 Case	17-4020



CAN01K-DV

Paddle Over Disc

APPARATUS 5



With paddle over disc, a transdermal patch is placed either between a glass disc and an inert PTFE mesh (APPFIVE-HR), or directly onto a stainless steel mesh (APPFIVE-V35, APPFIVE-V56 and APPFIVE-V80). This is placed at the bottom of the vessel, with the mesh facing upwards, under a rotating paddle.

Transdermal testing is carried out at 32°C to reflect the temperature of the skin.

Other variables such as the height setting and sampling requirements are the same as for USP Method 2.

The LabHut USP 5 apparatus is compatible with all brands of dissolution bath.

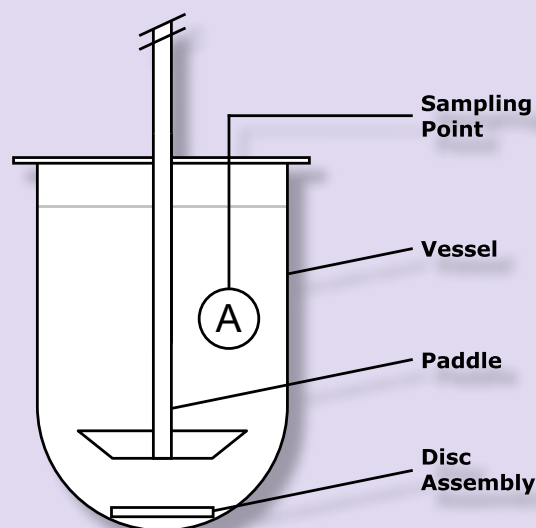

Key Considerations



The **APPFIVE-HR** watch glass patch holder is a borosilicate watch glass with a 17 mesh PTFE screen, held together by plastic clips. Patches up to 90mm in diameter can be tested. It is compatible with all brands of dissolution bath and conforms exactly to the USP specification.

The **APPFIVE-V35**, **APPFIVE-V56** and **APPFIVE-V80** patch holders have stainless steel screens and can accommodate various patch sizes.

Various meshes are available for APPFIVE-V35.



APPFIVE-HR



APPFIVE-HRCLIP



APPFIVE-HRSCR



APPFIVE-V80



APPFIVE-V56



APPFIVE-V35



APP5S16-35



APP5S20-35



APP5S30-35



APP5S40-35

Transdermal Patch Holders and Accessories

Part No.	Description	OEM Ref	
APPFIVE-HR	Watch Glass Transdermal Patch Holder with 17 Mesh Screen and 4 Plastic Clips	65-190-093	H
APPFIVE-HRCLIP	Plastic Clip for APPFIVE-HR (each)	65-190-205	H
APPFIVE-HRSCR	17 Mesh PTFE Screen for APPFIVE-HR	65-190-190	H
APPFIVE-V35	Transdermal Patch Holder, 1.38" (35mm) Opening (40 Mesh Screen)	12-4200	V
APPFIVE-V56	Transdermal Patch Holder, 2.20" (56mm) Opening (120 Mesh Screen)	12-4230	V
APPFIVE-V80	Transdermal Patch Holder, 3.15" (80mm) Opening (16 x 16 Mesh Screen)	-	
APP5S16-35	16 Mesh 316 Stainless Steel Screen for APPFIVE-V35 (pack of 25)	-	
APP5S20-35	20 Mesh 316 Stainless Steel Screen for APPFIVE-V35 (pack of 25)	-	
APP5S30-35	30 Mesh 316 Stainless Steel Screen for APPFIVE-V35 (pack of 25)	-	
APP5S40-35	40 Mesh 316 Stainless Steel Screen for APPFIVE-V35 (pack of 25)	-	



Rotating Cylinder

APPARATUS 6



The USP 6 rotating cylinder is similar to USP Method 1 (the rotating basket). With USP Method 6 however, the basket assembly is replaced by a solid stainless steel cylinder.

The transdermal patch is fixed to the outside surface of the cylinder.

Transdermal testing is carried out at 32°C to reflect the temperature of the skin.

Other variables such as the height setting and sampling requirements are the same as for USP Method 1.

The LabHut USP 6 apparatus is compatible with most brands of dissolution bath.

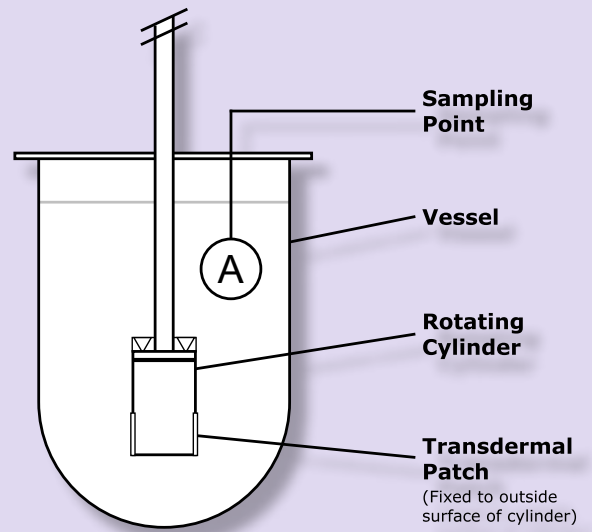

Key Considerations



The extension (APPSIX-EX) is used when the transdermal patch requires a larger area (see picture below).



APPSIX-01

H = Hanson
V = VanKel



Rotating Cylinder

Part No.	Description	OEM Ref	
APPSIX-01	Rotating Cylinder for Transdermal Patches, Electropolished 316 Stainless Steel	12-1360 65-590-011	V H
APPSIX-EX	Rotating Cylinder Extension for APPSIX-01, Electropolished 316 Stainless Steel	- 65-590-012	H

Spin On/Off

The rotating cylinder is also available as a Spin ON/OFF shaft. See SPNAP6-01 on page 9.

Caps & Covers

Part No.	Description	OEM Ref	
EVACOV-05	PVC Evaporation Cover for 300ml Glass Vessels	27-1500	✓
EVACOV-07	PTFE Evaporation Cover for 300ml Glass Vessels	-	
LOWCAP-03	Lower Cap for 300ml Glass Vessels	27-1020	✓
LOWCAP-05	Lower Cap for 300ml Glass Vessels, Wider VanKel Style	27-1050	✓
UPPCAP-03	Upper Cap for 300ml Glass Vessels	27-1000	✓



LOWCAP-03



LOWCAP-05



UPPCAP-03



EVACOV-05



EVACOV-07

Vessels & Sampling Tubes

Part No.	Description	OEM Ref	
GLA300-01	Outer Vessel, 300ml, Clear Glass, Non-graduated	-	
GLA300-02	Outer Vessel, 300ml, Clear Glass, Graduated	27-5100	✓
GLA300-03	Outer Vessel, 300ml, Clear Glass, Class A, with 250ml mark	-	
GLA300-AV	Outer Vessel, 300ml, Amber Glass, Non-graduated	-	
GLAIST-01	Inner Sampling Tube, 100ml, Clear Glass	27-5000	✓
GLAIST-AV	Inner Sampling Tube, 100ml, Amber Glass	-	



GLA300-01



GLA300-02



GLA300-03



GLA300-AV

Screens

Screens with 1.25" diameters for 300ml glass vessels.

Part No.	Description	OEM Ref	
MSHSCR-20	20 Mesh 316 Stainless Steel Screen	27-2100	✓
MSHSCR-30	30 Mesh 316 Stainless Steel Screen	27-2103	✓
MSHSCR-40	40 Mesh 316 Stainless Steel Screen	27-2105	✓
POLSCR-20	20 Mesh Polypropylene Screen	27-2000	✓
POLSCR-30	30 Mesh Polypropylene Screen	-	
POLSCR-40	40 Mesh Polypropylene Screen	27-2005	✓
POLSCR-1K	100 Mesh Polypropylene Screen	27-2015	✓



GLAIST-01



GLAIST-AV

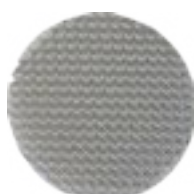

MSHSCR-20



MSHSCR-30



MSHSCR-40

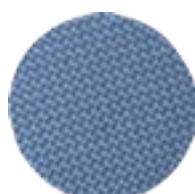

POLSCR-20



POLSCR-30



POLSCR-40



POLSCR-1K



The Stationary Basket

APPARATUS 26



The USP Monograph for Felodipine Extended-Release Tablets specifies the use of a quadrangular stationary basket. The LabHut Stationary Basket fully complies with the USP Monograph.

The LabHut Felodipine Basket is made from precision welded stainless steel mesh and the basket is securely fixed to the shaft and will not easily bend or break off.

The basket also features a small flap to prevent the tablet escaping during testing. The flap is fabricated such that it will not fall off or be lost during use.

USP 26 requires the use of a basket suspended a precise distance from the paddle shaft, which in turn requires the use of a modified vessel cover.

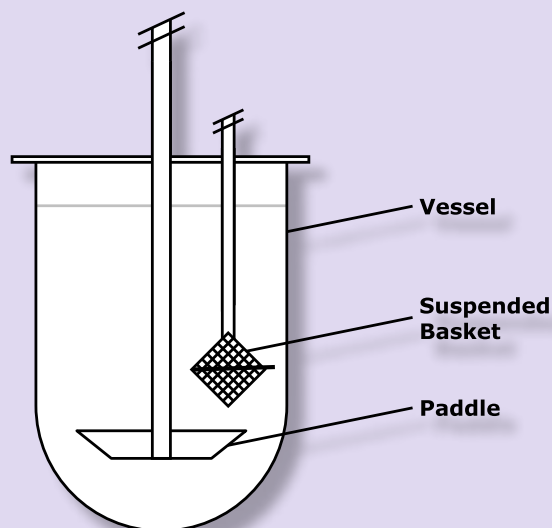

Key Considerations



The Stationary Basket method offers a potential solution to problems associated with floating, sticking and swelling dosage forms.

While the use of sinkers may solve similar problems, their final position in the dissolution vessel may vary, thus contributing to variations in test results – these variations can be eliminated by using the stationary basket.

(Suitability for certain applications must be verified.)



Felodipine Stationary Basket

Part No.	Description	OEM Ref
STABSK-VK8	USP 26 Felodipine Test Stationary Basket	12-2069 V

Compatible Vessel Covers (See page 20)

Part No.	Description	OEM Ref
COVDHG-SB	Clear Stationary Basket Apparatus Hinged Cover for Distek Baths D	3250-0081
COVHGV-SB	Clear Stationary Basket Apparatus Hinged Cover for VanKel Baths	-

D = Distek
V = VanKel

Stationary Basket Spacer (See page 37)

Part No.	Description	OEM Ref
DEPSET-SB	Stationary Basket Spacer, 1cm	-

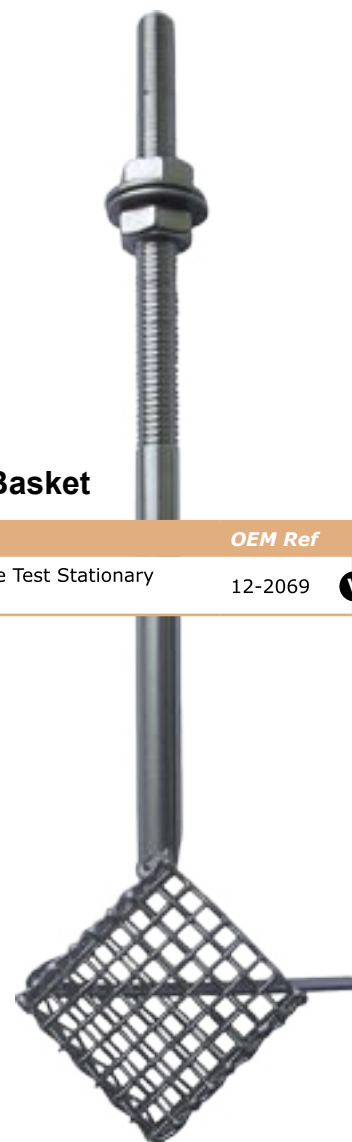

Controlling Hardware Variables

To achieve reliable and consistent results in dissolution testing it is essential to control many small variables. Some of these variables have been defined in the USP and some have yet to be addressed in the compendium due to a lack of data or disagreements about how they can be measured. The variables are described below in Key Considerations.

Key Considerations

Wobble

Use: **WOBMET-MI**

The USP limit for wobble is $\pm 2\text{mm}$. If there is significant wobble it can have a significant effect on the dissolution rate. The wobble can be caused by a bent or loose shaft or a misshapen basket.

The easiest way to check for wobble is by eye (2mm will be easily seen) but it should be quantified by a suitable tool. To check shaft straightness simply roll the shaft over a bench top – it should roll smoothly and not stick up at the end. Wobble can be kept to a minimum by handling the baskets and shafts with care – they should be kept in proper holders rather than just collectively in a drawer. See page 11 for basket shaft/paddle holders.

Wobble is measured just above the paddle blade or on the bottom rim of the basket.



Vibration

Use: **VIBMET-UN**

Vibration is one of the most significant causes of failure but is not yet defined within the USP (it states 'no significant vibration'). Part of the problem is defining what limits should be acceptable as vibration varies with frequency.

Vibration should be seen as excess energy which is transferred to the vessel and will almost certainly increase the dissolution rate. An increase of 5-10% is possible.

The most common cause of vibration is the water bath pump or a worn drive belt in the motor unit. Other causes of vibration are typically caused by other pieces of equipment on the same bench.



Shaft Centering

Use: **CNTGAG-MI**



The USP definition for stirring is that the shaft should be within $\pm 2\text{mm}$ of the centre. This parameter is fairly easy to measure in open-design dissolution baths but is difficult to measure in the 'clam shutting' designs.

Shaft centering is dependent on two parameters – the position of the spindle (this is factory-set) and the position of the vessels. If the vessels are not set correctly or are loose then there is a possibility that the centering will be incorrect. An off-centre shaft can add significantly to the dissolution rate.

Basket & Paddle Height

Use: **DEPSET-MI**

The USP states that the bottom of the basket/paddle is 25mm $\pm 2\text{mm}$ above the bottom of the vessel. This parameter is normally measured using one of several designs of height tester. The height is important for having reproducible media hydrodynamics. Incorrectly set paddle heights can cause both high and low readings.



Shaft RPM

Use: **TACHOM-UN**



The USP limit for stirring is $\pm 4\%$ of the set speed of the test. This level of shaft control was set during the early days of equipment manufacturing where surging motors (which temporarily increased or decreased the speed) were difficult to control. All modern equipment can now control the speed to within $\pm 0.5\text{rpm}$ so this problem is rare. However the RPM still needs to be validated with a suitable tachometer.

Vessels

See: **Vessels (page 16)**

Vessel design is something that is often overlooked by the analyst. The USP allows for a significant variation in the specification of the vessels with a height of 160-170mm and an ID of 98-106mm. This variation means that if vessels are changed in the bath then the paddle height and centering measurements need to be rechecked.

Vessels should ideally be serialised. They should be smooth and clean. Small ridges on the inside of a vessel can greatly increase the dissolution rate whilst scratches and sticky or gummy patches can reduce the dissolution rate.

Bath Level

Use: **LEVEL-UN**

The level of a dissolution bath is often overlooked. It should not be assumed that the laboratory bench is level. This is one of the parameters that should be checked on installation and some dissolution testers have an in-built level checking device.

Testers which are not level can give erroneous results and the media rotation is not linear within the vessel.

Level should be tested front to back as well as side to side. A calibrated level will provide an accurate measurement of this. If the bath is moved for any reason then this parameter will need to be re-checked.



Vertical Alignment

The vertical alignment of the shafts to the base of the dissolution bath is critical to the correct operation of the system. From an adjustment point of view, there is little that the user can do about it and it should be set by the manufacturer.

However, it is a good idea to check the alignment – this should always be checked by the manufacturer on installation because physical trauma can occur during shipping. If an error is found then the manufacturer should be contacted to correct the problem.

The simplest method to check the alignment yourself is with a set square available from any tool store. Remove the vessels and lower the shaft until it is just below the base plate. Take the square and align it with the base and shaft to check the vertical alignment of the shaft.

Temperature

Use: **THERMD-LC**

Temperature control in tablet dissolution testing is critical as a change in temperature has a linear effect on the dissolution rate. Temperature should be measured with a calibrated thermometer, either analogue or digital, and should normally be 37°C.

The specified temperature should be measured in each vessel prior to each run commencing. There is a temptation to only measure temperature in a few of the vessels and assume that they are all the same. This may not necessarily be the case as temperature gradients can occur within a water bath that affect the speed of equilibration of all the vessels.

Most dissolution baths display the temperature of the bath itself but this should not be taken as an indication of the temperature inside the vessel. Typically it is necessary to run the water bath as much as 0.5°C or so above the required temperature to ensure the correct temperature inside the vessel. If plastic vessels are used instead of glass then this may result in a greater difference in temperature.





Calibration Tools

Part No.	Description	OEM Ref
CNTGAG-MI	Multi-Instrument Vessel Centering Gauge	-
DEPGAG-VK	Depth Set Gauge, VanKel Style	12-7300 V
DEPSET-MI	Ball Style Depth Set Gauge	-
DEPSET-SB	Stationary Basket Spacer, 1cm	-
DPSPBK-VK	Basket Height Spacer	12-7210 V
DSPSPD-VK	Paddle Height Spacer	12-7200 V
LEVEL-UN	Universal Precision Spirit Level	-
TACHOM-UN	Optical Tachometer	-
THERMD-LC	Calibrated Digital Thermometer	-
VALTOL-KT	Validation Toolkit (centering gauge, depth set gauge, level, wobble meter)	-
VALTOL-CUST	Custom Validation Toolkit (any combination of calibration tools)	-
VIBMET-UN	Vibration Meter with probe and case	-
WOBMET-MI	Wobble Meter (including vessel cover and brackets) for all open top baths	-



VALTOL-KT



CNTGAG-MI

WOBMET-MI

DEPGAG-VK

LEVEL-UN



DEPSET-SB



DPSPBK-VK



DSPSPD-VK



DEPSET-MI



TACHOM-UN

Re-Calibration Service

Part No.	Description
RECAL-CG	Vessel Centering Gauge Recalibration Service
RECAL-LV	Universal Spirit Level Recalibration Service
RECAL-TA	Optical Tachometer Recalibration Service
RECAL-VM	Vibration Meter Recalibration Service
RECAL-WM	Wobble Meter Recalibration Service

(Re-calibration recommended on an annual basis)

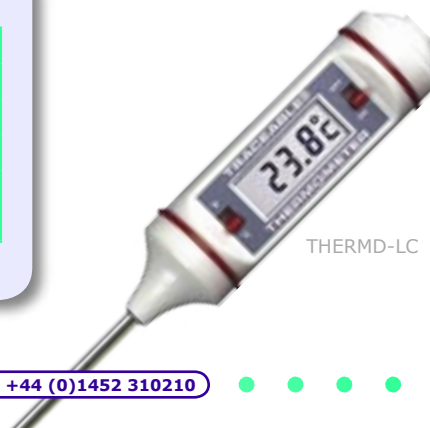

THERMD-LC



VIBMET-UN

V = VanKel



Volumetric Flasks

Part No.	Description	OEM Ref
VOLFLK-05	500ml Volumetric Flask, Class A, Calibrated at 20°C	-
VOLFLK-09	900ml Volumetric Flask, Class A, Calibrated at 20°C	-
VOLFLK-1K	1000ml Volumetric Flask, Class A, Calibrated at 20°C	-
VOLFLK-X5	500ml Volumetric Flask, Class A, Calibrated at 37°C	-
VOLFLK-X9	900ml Volumetric Flask, Class A, Calibrated at 37°C	-
VOLFLK-X1	1000ml Volumetric Flask, Class A, Calibrated at 37°C	-



VOLFLK-05



VOLFLK-X9



VOLFLK-X1

Tapped Density

Part No.	Description	OEM Ref
GLA100-01	100ml Funnel Top Cylinder, Graduated, Hexagonal Base	52-5010
GLA1CA-01	100ml Funnel Top Cylinder, Graduated, Hexagonal Base, Class A, Calibrated at 20°C	-
GLA250-01	250ml Funnel Top Cylinder, Graduated, Hexagonal Base	52-5020



GLA100-01



GLA1CA-01



GLA250-01

Rotating Bottle Apparatus

Part No.	Description	OEM Ref
RBAASSY-01	100ml Clear Glass Bottle and Cap, Viton Liner	-
RBAASSY-02	100ml Clear Glass Bottle and Decant Cap, 40 Mesh Screen	-
RBSCRN-40	40 Mesh Screen for 100ml Decant Cap	32-1220



RBAASSY-01



RBAASSY-02



RBSCRN-40

Misc Glass Accessories

Part No.	Description	OEM Ref
FLEAK-150	100ml Glass Fleaker	-
FLEAK-300	300ml Glass Fleaker	-
GLATUB-A/ 25x150mm	50ml Amber Outer Media Tube for 12 Valve APP 7	27-5160



FLEAK-150



FLEAK-300



GLATUB-A/25x150mm

“Wood Apparatus Design”



The Intrinsic Dissolution Apparatus below is based on the conventional “Wood Apparatus Design”. This industry standard configuration has a long and successful history.

This design uses standard dissolution vessels and provides better centering and easier dosage placement than competing designs.

Intrinsic Dissolution Apparatus

Part No.	Description	OEM Ref	
IDASET-01	Intrinsic Dissolution Apparatus Set	-	H
IDADIE-01	8mm Intrinsic Die with Gasket, 316 Stainless Steel	12-4120	V
		95-590-204	H
IDAPCH-01	8mm Punch and Handle	12-4140	V
		95-590-203	H
IDAPLT-01	Surface Plate with Screws	12-4130	V
		95-590-205	H
IDAPRS-01	2 Ton Universal Intrinsic Press	-	H
		95-590-206	V
IDASNH-01	Shaft and Holder, 316 Stainless Steel	12-4150	V
		95-590-202	H

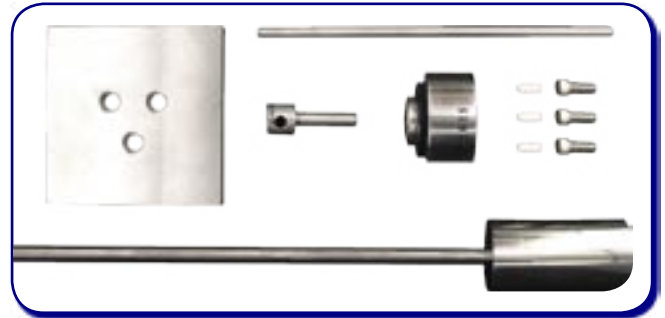

IDASET-01

(Set includes: IDADIE-01, IDAPCH-01, IDAPLT-01, IDASNH-01)



IDADIE-01



IDAPCH-01

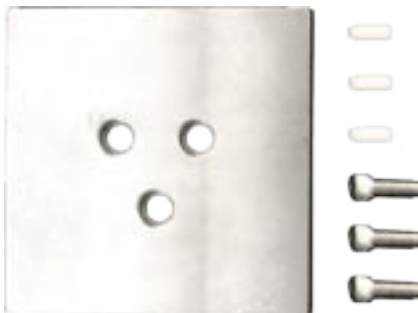

IDAPLT-01



IDAPRS-01



IDASNH-01

H = Hanson
V = VanKel



VanKel Disintegration Accessories

Part No.	Description	OEM Ref
DISASY-06	Basket Assembly with 6 Glass Tubes and 10 Mesh Stainless Steel Screens, for VanKel	37-2001
DISASY-P6	Basket Assembly with 6 Plastic Tubes and 10 Mesh Stainless Steel Screens, for VanKel	-
DISTUB-06	Glass Disintegration Tubes for 6 Tube Assembly	37-5000
DISTUB-P6	Plastic Disintegration Tubes for 6 Tube Assembly	-
FDISK-VK	Fluted Plastic Disc for 6 Tube Assembly	37-4000
GLA900-DB	900ml Disintegration Beaker, Flared Top	37-5200
GLA905-DB	900ml Disintegration Beaker, Flat Top	37-5305



DISASY-06 / DISASY-P6



DISTUB-06



DISTUB-P6



FDISK-VK



GLA900-DB



GLA905-DB

Zymark Compatible Baskets

Part No.	Description	OEM Ref
BSK040-ZM	40 Mesh Stainless Steel Basket	63127
BSK040-ZM2	40 Mesh Precision Length Stainless Steel Basket	-



BSK040-ZM



BSK040-ZM2

Precision Length Basket

The Precision Length Basket (BSK040-ZM2) is specifically designed for use with Caliper Multidose and other robotic dissolution systems. It has a long usable life in the demanding robotic environment.

Zymark Compatible Basket Shafts

Part No.	Description	OEM Ref
BSKSHT-ZM2	15" (380mm) Double O-Ring Style Conical Basket Shaft	-

Spin On/Off

The double O-ring conical basket shaft is also available as a Spin ON/OFF shaft. See SPNBSK-ZM2 on page 9.



BSKSHT-ZM2

Zymark Compatible Vessels

Part No.	Description	OEM Ref
GLA9CR-ZM	1000ml Clear Glass Vessel with Centering Ring	58730
CNTRNG-ZM	Multidose Centering Ring	69606



GLA9CR-ZM



CNTRNG-ZM

Zymark Miscellaneous

Part No.	Description	OEM Ref
ADTPIN-ZM	Multidose Adapter Pin	48481
LOCPIN-ZM	Multidose Locater Pin	48479
RETRNG-ZM	Multidose Vessel Retainer	-



RETRNG-ZM

Tubing

Part No.	Description	OEM Ref	
PPTUBV-01	Peristaltic Pump Tubing, Santoprene, Coded Purple & White (Set of 8)	17-6000	V
PPTUBV-02	Peristaltic Pump Tubing, Silicone, Coded Purple & White (Set of 8)	17-6010	V
PPTUBD-01	Peristaltic Pump Tubing, Santoprene (Set of 6)	5640-0337	D
TAATUB-HP	3 Collar Tygon Auto Analyser Tubing, 0.08" (2.06mm) ID (Set of 12)	5041-2166	D
TEFTUB-HP	FEP PTFE Tubing for HP 1/32" (0.8mm) ID x 1/16" (1.6mm) OD, 500' (152m) Roll	-	
TEFTUB-8V	Colour Coded Sample PTFE Tubing, 0.42" (10.67mm) ID x 0.066" (1.68mm) OD, 8 Lengths of 50' (15m)	17-6035	V
TUBING	Tygon Tubing, 1/16" (1.6mm) x 1/8" (3.2mm) (Sold by Foot)	-	



PPTUBV-01



PPTUBV-02



PPTUBD-01



TEFTUB-8V



TEFTUB-HP



TAATUB-HP



TUBING

D = Distek

V = VanKel

Paper Rolls

Part No.	Description	OEM Ref	
PAP100-01	Plain Paper Rolls for Report Center II, 2.25" (57mm) Wide (Pack of 25)	12-9995	V
TPP100-01	Thermal Paper Rolls (Pack of 25)	12-9994	V



PAP100-01



TPP100-01

Clear Bath Algaecide

Clear Bath is a liquid algae inhibitor for use with all types of dissolution bath. Using just 10-15 drops per gallon keeps a dissolution bath clean. One bottle will treat 1500 to 1900 litres of water.

Part No.	Description	OEM Ref
105540	Clear Bath Algaecide, 230ml (8fl oz) Bottle	-



105540

Glass Syringes

Part No.	Description	OEM Ref	
SYR020-01	20cc Glass Syringe	12-3230	V



SYR020-01

Caleva OEM Reference

OEM Ref	Part No.	Page No.
0810004	GLA900-CA	17
0810009	GLA900-AC	17
0810019	BSK040-CA	5
0810021	BSK020-CA	5
0810097	FIL040-CA-100	23
0810098	FIL040-CA-1000	23
0810100	FIL001-CA-100	23
0810101	FIL001-CA-1000	23
0810103	FIL004-CA-100	23
0810104	FIL004-CA-1000	23
0810106	FIL010-CA-100	23
0810107	FIL010-CA-1000	23
0810123	BSK010-CA	5
0810142	FIL035-CA-100	23
0810143	FIL035-CA-1000	23

Erweka OEM Reference

OEM Ref	Part No.	Page No.
80-000-1002	GLA900-EW	17
80-000-1004	GLA900-AW	17
80-000-2002	GLA02K-EW	17
90-000-0013	FIL001-EW-100 FIL001-EW-1000	23
90-000-0015	BSK020-EW	5
90-000-0023	FIL004-EW-100 FIL004-EW-1000	23
90-000-0033	FIL010-EW-100 FIL010-EW-1000	23
90-000-0040	BSK040-EW	5

Pharmatest OEM Reference

OEM Ref	Part No.	Page No.
303-5225	GLA900-PT	18
303-5425	GLA900-AT	18
31-63211-50	FIL-035-PT-1000	24
31-63511-50	FIL-005-PT-100	24

Distek OEM Reference

OEM Ref	Part No.	Page No.
2800-0002	NPD016-02	10
2800-0010	EPD016-02	10
2800-0032	BSK040-DKC	5
2800-0041	BSK010-DKC	5
2800-0042	BSK020-DKC	5
2800-0165	SHFT16.5-DK	8
2800-0178	TPD016-02	10
2821-0072	BSK040-DK	5
2821-0074	BSDRNG-16	8
2821-0097	BSDRNG-19	8
2821-0159	BSK020-DK	5
2821-0160	BSK010-DK	5
2821-0257	VSCCLIP-DK	17
2851-1052	BSKHUB-DK	8
2910-0001	CANRET-DK	27
2910-0500	CAN500-DK	27
2910-0900	CAN900-DK	27
2910-1000	CAN01K-DK	27
3010-0023	GLA9CR-AD	17
3010-0069	GLA900-DK	17
3010-0093	GLA9CR-DK	17
3010-0095	GLA200-DK	17
3010-0285	GLA02K-DK	17
3010-0550	GLA9PK-DK	17
3100-0017	BSKCLP-DK	8
3200-0038	BSKHUB-DKC	8
3250-0019	COVCAP-DK	20
3250-0070	COVERD-BK	20
3250-0081	COVDHG-SB	20,35
3250-0089	COVERD-01	20
3250-0445	BSKSUP-DK	5
3350-0095	PLA900-DK	17
3350-0096	RING01-DK	17
3350-0109	COVPLG-7D	20
5041-2166	TAATUB-HP	42
5560-6011	HINGE-DK	20
5640-0337	PPTUBD-01	42
5720-0020-100	FIL45S-DK-100	23
5720-0020-1000	FIL45S-DK-1000	23
5720-0203	FIL010-DK	23
5720-0220-100	FIL35S-DK-100	23
5720-0220-1000	FIL35S-DK-1000	23
5720-0275	FIL045-DK	23
5720-0500	FIL10S-DK-100	23
5720-0501	FIL10S-DK-1000	23
5720-0502	FIL70S-DK-100	23
5720-0503	FIL70S-DK-1000	23
5720-4037	COVPLG-DK	20
5720-9059	SFTL-6	27
5720-9060	SMTLL-6	27
5720-9074	LE87-6	27

Hanson OEM Reference

OEM Ref	Part No.	Page No.
27-101-074	FIL010-HR-100	24
27-101-082	FIL070-HR-100	24
27-101-083	FIL10S-HR-100	24,31
27-101-084	FIL70S-HR-100	24,31
27-101-085	FIL035-HR-100	24
27-101-086	FIL35S-HR-100	24,31
27-101-087	FIL001-HR-100	24
27-101-088	FIL004-HR-100	24
27-101-089	FIL045-HR-100	24
27-101-090	FIL45S-HR-100	24,31
27-101-091	FIL010-HR-1000	24
27-101-092	FIL070-HR-1000	24
27-101-093	FIL10S-HR-1000	24,31
27-101-094	FIL70S-HR-1000	24,31
27-101-095	FIL035-HR-1000	24
27-101-096	FIL35S-HR-1000	24,31
27-101-097	FIL001-HR-1000	24
27-101-098	FIL004-HR-1000	24
65-190-093	APPFIVE-HR	32
65-190-190	APPFIVE-HRSCR	32
65-190-205	APPFIVE-HRCLIP	32
65-220-000	BSK040-HR	6
65-220-010	BSK010-HR	6
65-220-020	BSK020-HR	6
65-233-170	COVERH-00	20
65-237-000	BSKSH-16	8
65-590-011	APPSIX-01	33
65-590-012	APPSIX-EX	33
65-700-030	NPD016-01	10
65-700-036	EPD016-01	10
65-700-048	BSKSUP-HR	6
72-300-304	CAN015-HR	28
72-500-215	COVERH-01	20
72-600-509	GLA02K-HR	18
72-600-510	GLA900-HR	18
72-600-556	GLA900-AH	18
72-800-456	TPD016-01	10
72-800-461	TPD018-01	10
72-800-603	COVERH-02	20
91-030-003	PLA900-HR	18
95-590-001	CAN775-SH	28
95-590-002	CAN475-SH	28
95-590-003	CAN015-SH	28
95-590-004	CAN775-PH	28
95-590-005	CAN475-PH	28
95-590-006	CAN015-PH	28
95-590-046	COVERH-HG	20
95-590-201	IDASET-01	39
95-590-202	IDASNH-01	39
95-590-203	IDAPCH-01	39
95-590-204	IDADIE-01	39
95-590-205	IDAPLT-01	39
95-590-206	IDAPRS-01	39

VanKel OEM Reference

OEM Ref	Part No.	Page No.
12-0469	COVERV-LL	20
12-1000	NPD015-01	10
12-1005	NPD013-01	10
12-1010	NPD019-01	10
12-1030	EPD015-01	10
12-1035	EPD013-01	10
12-1040	EPD019-01	10
12-1360	APPSIX-01	33
12-1400	SPNSHT-15	9
12-1401	SPNSHT-19	9
12-1420	SPNNPD-01	9
12-1421	SPNEPD-01	9
12-1430	SPNBSK-01	9
12-1431	SPNRNG-01	9
12-2050	BSKSHT-15CO	8
12-2060	STABSK-20	7
12-2061	STABSK-10	7
12-2063	STABSK-40	7
12-2069	STABSK-VK8	35
12-2070	BSKSHT-15	8
12-2073	BSKSHT-13	8
12-2075	BSKSHT-15C	8
12-2080	BSKSHT-19	8
12-2100	BSK040-01	7
12-2110	BSKPTV-40	7
12-2120	BSK020-01	7
12-2125	BSK010-01	7
12-2130	BSKSUP-01	7
12-2152	BSK150-01	7
12-2154	BSK100-01	7
12-3000	WIRESK-VK	13
12-3050	CAPWHT-VK	12
12-3056	MAGWHT-VK	12
12-3060	SNK010-VK	12
12-3062	SNK008-VK	12
12-3064	SNK040-VK	12
12-3070	CUSBSK-JP	12
12-3200	CAN475-01	30
12-3210	CAN775-01	30
12-3230	SYR020-01	42
12-4120	IDADIE-01	39
12-4130	IDAPLT-01	39
12-4140	IDAPCH-01	39
12-4150	IDASNH-01	39
12-4200	APPFIVE-V35	32
12-4230	APPFIVE-V56	32
12-5000	GLA900-01	19
12-5010	GLA900-AV	19
12-5020	GLA9AM-VK	19
12-5035	GLA900-VK	19
12-5040	GLA100-VK	19

VanKel OEM Reference

OEM Ref	Part No.	Page No.
12-5050	GLA200-VK	19
12-5060	GLA500-01	19
12-5070	GLA02K-01	19
12-5125	GLA9PK-VK	19
12-5200	PLA900-01	19
12-5500	GLA9PK-01	19
12-6000	VK600A-CR	19
12-6050	EZLBKT-01	19
12-6065	EZLPEG-01	19
12-6200	COVERV-6K	20
12-6300	COVERV-01	20
12-6310	COVERV-04	20
12-6320	COVERV-02	20
12-6327	COVERV-LLVS	20
12-6328	COVERV-LLHG	20
12-6330	COVERV-03	20
12-7200	DPSPPD-VK	37
12-7210	DPSPBK-VK	37
12-7300	DEPGAG-VK	37
12-9994	TPP100-01	42
12-9995	PAP100-01	42
17-3300	CAN900-45	30
17-3305	CAN500-60	30
17-3306	PROBEX-VK	30
17-3320	CANRET-25	30
17-4000	FIL010-01-100/ FIL010-01-1000	25,31
17-4010	FIL035-01-100/ FIL035-01-1000	25,31
17-4020	FIL070-01-100/ FIL070-01-1000	25,31
17-4100	FILTIP-02	25
17-4110	FILTIP-05	25
17-4120	FILTIP-10	25
17-4130	FILTIP-20	25
17-4140	FILTIP-45	25
17-6000	PPTUBV-01	42
17-6010	PPTUBV-02	42
17-6035	TEFTUB-8V	42
27-1000	UPPCAP-03	34
27-1020	LOWCAP-03	34
27-1050	LOWCAP-05	34
27-1500	EVACOV-05	34
27-2000	POLSCR-20	34
27-2005	POLSCR-40	34
27-2015	POLSCR-1K	34
27-2100	MSHSCR-20	34
27-2103	MSHSCR-30	34
27-2105	MSHSCR-40	34
27-5000	GLAIST-01	34
27-5100	GLA300-02	34

VanKel OEM Reference

OEM Ref	Part No.	Page No.
27-5160	GLATUB-A/ 25x150mm	38
32-1220	RBSCRN-40	38
37-2001	DISASY-06	40
37-4000	FDISK-VK	40
37-5000	DISTUB-06	40
37-5200	GLA900-DB	40
37-5305	GLA905-DB	40
52-5010	GLA100-01	38
52-5020	GLA250-01	38

Sotax OEM Reference

OEM Ref	Part No.	Page No.
2503	GLA900-ST	19
2503-2	GLA900-AS	19
2830	BSK040-SX	6
6881	CAPWST-23	13
7346	CAPWST-18	13
7349	CAPWST-31	13
8280	CAPWST-15	13
8283	CAPWST-19	13
8399	CAPWHT-S99	12

Zymark OEM Reference

OEM Ref	Part No.	Page No.
48479	LOCPIN-ZM	41
48481	ADTPIN-ZM	41
58730	GLA9CR-ZM	41
63127	BSK040-ZM	41
69606	CNTRNG-ZM	41

If you cannot find what you need
please contact us

 sales@labhut.com

 +44 (0)1452 310210

 +44 (0)1452 300075

Part No.	Page No.	Part No.	Page No.	Part No.	Page No.	Part No.	Page No.	Part No.	Page No.
105540	42	BSKSHT-15CO	8	CANSTP-125-53	28	DEPGAG-VK	37	FIL020-EW-100	23
ADTPIN-ZM	41	BSKSHT-16	8	CANSTP-142-31	30	DEPSET-MI	37	FIL020-EW-1000	23
APP5S16-35	32	BSKSHT-19	8	CANSTP-CA	27	DEPSET-SB	35,37	FIL020-HR-100	24
APP5S20-35	32	BSKSHT-ZM2	41	CANSTP-EW	28	DISASY-06	40	FIL020-HR-1000	24
APP5S30-35	32	BSKSUP-01	7	CANSTP-PT	29	DISASY-P6	40	FIL035-01-100	25,31
APP5S40-35	32	BSKSUP-CA	5	CANSTP-ST	29	DISP475-HR	31	FIL035-01-1000	25,31
APPFIVE-HR	32	BSKSUP-DK	5	CAPWHT-02	13	DISPCAN-CUST	31	FIL035-CA-100	23
APPFIVE-HRCLIP	32	BSKSUP-EW	5	CAPWHT-04	13	DISTUB-06	40	FIL035-CA-1000	23
APPFIVE-HRSCR	32	BSKSUP-HR	6	CAPWHT2S	13	DISTUB-P6	40	FIL035-EW-100	23
APPFIVE-V35	32	BSKSUP-PT	6	CAPWHT-4S	13	DPSPBK-VK	37	FIL035-EW-1000	23
APPFIVE-V56	32	BSKSUP-SX	6	CAPWHT-CUS	13	DPSPPD-VK	37	FIL035-HR-100	24
APPFIVE-V80	32	CA8015-PV	30	CAPWHT-LG	13	EPD013-01	10	FIL035-HR-1000	24
APPSIX-01	33	CA8015-VK	30	CAPWHT-PC	13	EPD015-01	10	FIL035-PT-100	24
APPSIX-EX	33	CA8475-PV	30	CAPWHT-S99	12	EPD016-01	10	FIL035-PT-1000	24
BSDRNG-16	8	CA8475-VK	30	CAPWHT-SV	12	EPD016-02	10	FIL035-SX-100	25
BSDRNG-19	8	CA8775-PV	30	CAPWHT-TR	13	EPD019-01	10	FIL035-SX-1000	25
BSHT16-02	8	CA8775-VK	30	CAPWHT-VK	12	EVACOV-05	34	FIL035-VK-100	25
BSK008-01	12	CADSTP-ST	29	CAPWHT-XL	13	EVACOV-07	34	FIL035-VK-1000	25
BSK008-JP	12	CAN013-ST	29	CAPWHT-XS	13	EZLBKT-01	19	FIL040-CA-100	23
BSK010-01	7	CAN013-ST-5	29	CAPWST-15	13	EZLKIT-01	19	FIL040-CA-1000	23
BSK010-CA	5	CAN013-ST-9	29	CAPWST-18	13	EZLPEG-01	19	FIL040-EW-100	23
BSK010-DK	5	CAN015-HR	28	CAPWST-19	13	FDISK-VK	40	FIL040-EW-1000	23
BSK010-DKC	5	CAN015-PH	28	CAPWST-23	13	FIL001-CA-100	23	FIL045-01-100	25,31
BSK010-HR	6	CAN015-SH	28	CAPWST-31	13	FIL001-CA-1000	23	FIL045-01-1000	25,31
BSK010-PT	6	CAN01K-DK	27	CNTGAG-MI	37	FIL001-EW-100	23	FIL045-DK	23
BSK010-SX	6	CAN01K-DV	31	CNTRNG-ZM	41	FIL001-EW-1000	23	FIL045-HR-100	24
BSK020-01	7	CAN475-01	30	COVCAP-AD	20	FIL001-HR-100	24	FIL045-HR-1000	24
BSK020-CA	5	CAN475-HR	28	COVCAP-DK	20	FIL001-HR-1000	24	FIL070-01-100	25,31
BSK020-DK	5	CAN475-PC	27	COVDHG-SB	20,35	FIL001-PT-100	24	FIL070-01-1000	25,31
BSK020-DKC	5	CAN475-PH	28	COVERAD-BK	20	FIL001-PT-1000	24	FIL070-CA-100	23
BSK020-EW	5	CAN475-PP	29	COVERD-00	20	FIL004-CA-100	23	FIL070-CA-1000	23
BSK020-HR	6	CAN475-SC	27	COVERD-01	20	FIL004-CA-1000	23	FIL070-DK	23
BSK020-PT	6	CAN475-SH	28	COVERD-02	20	FIL004-EW-100	23	FIL070-EW-100	23
BSK020-SX	6	CAN475-SP	29	COVERD-BK	20	FIL004-EW-1000	23	FIL070-EW-1000	23
BSK040-01	7	CAN500-60	30	COVERD-HG	20	FIL004-HR-100	24	FIL070-HR-100	24
BSK040-01PL	7	CAN500-DK	27	COVERH-00	20	FIL004-HR-1000	24	FIL070-HR-1000	24
BSK040-CA	5	CAN500-DV	31	COVERH-01	20	FIL004-PT-100	24	FIL070-PT-100	24
BSK040-DK	5	CAN5PK-DK16	27	COVERH-02	20	FIL004-PT-1000	24	FIL070-PT-1000	24
BSK040-DKC	5	CAN775-01	30	COVERH-03	20	FIL005-PT-100	24	FIL070-SX-100	25
BSK040-EW	5	CAN775-HR	28	COVERH-04	20	FIL005-PT-1000	24	FIL070-SX-1000	25
BSK040-HR	6	CAN775-PC	27	COVERH-HG	20	FIL010-01-100	25,31	FIL070-VK-100	25
BSK040-PT	6	CAN775-PH	28	COVERH-LL	20	FIL010-01-1000	25,31	FIL070-VK-1000	25
BSK040-SX	6	CAN775-PP	29	COVERV-00	20	FIL010-CA-100	23	FIL090-DK	23
BSK040-ZM	41	CAN775-SC	27	COVERV-01	20	FIL010-CA-1000	23	FIL10S-DK-100	23
BSK040-ZM2	41	CAN775-SH	28	COVERV-02	20	FIL010-DK	23	FIL10S-DK-1000	23
BSK100-01	7	CAN775-SP	29	COVERV-03	20	FIL010-EW-100	23	FIL10S-HR-100	24,31
BSK150-01	7	CAN900-45	30	COVERV-04	20	FIL010-EW-1000	23	FIL10S-HR-1000	24,31
BSKCLP-DK	8	CAN900-DK	27	COVERV-6K	20	FIL010-HR-100	24	FIL20S-DK-100	23
BSKHLD-12	7	CAN900-DV	31	COVERV-HG	20	FIL010-HR-1000	24	FIL20S-DK-1000	23
BSKHUB-DK	8	CAN9PK-DK8	27	COVERV-LL	20	FIL010-PT-100	24	FIL35S-DK-100	23
BSKHUB-DKC	8	CANRET-25	30	COVERV-LLHG	20	FIL010-PT-1000	24	FIL35S-DK-1000	23
BSKP TD-40	5	CANRET-DK	27	COVERV-LLSB	20	FIL010-SX-100	25	FIL35S-HR-100	24,31
BSKPTH-40	6	CANS15-PH	28	COVERV-LLVS	20	FIL010-SX-1000	25	FIL35S-HR-1000	24,31
BSKP TV-40	7	CANS15-SH	28	COVHGV-SB	20,35	FIL010-VK-100	25	FIL45S-DK-100	23
BSKSHT-13	8	CANSTP-065-53	27,28	COVPLG-7D	20	FIL010-VK-1000	25	FIL45S-DK-1000	23
BSKSHT-15	8	CANSTP-078-31	30	COVPLG-DK	20	FIL020-01-100	25,31	FIL45S-HR-100	24,31
BSKSHT-15C	8	CANSTP-125-31	28	CUSBSK-JP	12	FIL020-01-1000	25,31	FIL45S-HR-1000	24,31

Part No.	Page No.	Part No.	Page No.	Part No.	Page No.	Part No.	Page No.
FIL70S-DK-100	23	GLA9PK-DK	17	PROBEX-VK	30	VOLFLK-X1	38
FIL70S-DK-1000	23	GLA9PK-HR	18	RBAASSY-01	38	VOLFLK-X5	38
FIL70S-HR-100	24,31	GLA9PK-VK	19	RBAASSY-02	38	VOLFLK-X9	38
FIL70S-HR-1000	24,31	GLAIST-01	34	RBSCRN-40	38	VSCLIP-DK	17
FILASY-DK	27	GLAIST-AV	34	RECAL-CG	37	WIRESK-VK	13
FILTIP-02	25	GLATUB-A/ 25x150mm	38	RECAL-LV	37	WOBMET-MI	37
FILTIP-05	25	HINGE-DK	20	RECAL-TA	37		
FILTIP-10	25	IDADIE-01	39	RECAL-VM	37		
FILTIP-20	25	IDADIE-01	39	RECAL-WM	37		
FILTIP-45	25	IDADIE-01	39	RETRNG-ZM	41		
FLEAK-150	38	IDAPCH-01	39	RING01-DK	17		
FLEAK-300	38	IDAPCH-01	39	SFTL-6	27		
FLU900-01	19	IDAPLT-01	39	SHFT16.5-DK	8		
FLU900-DK	17	IDAPLT-01	39	SMTLL-6	27		
FLU900-HR	18	IDAPRS-01	39	SNK008-VK	12		
FLU9CL-01	19	IDAPRS-01	39	SNK010-VK	12		
FLU9CL-DK	17	IDASET-01	39	SNK040-VK	12		
FLU9CL-HR	18	IDASET-01	39	SPNAP6-01	9		
GLA02K-01	19	IDASNH-01	39	SPNBSK-01	9		
GLA02K-DK	17	IDASNH-01	39	SPNBSK-ZM2	9		
GLA02K-EW	17	LE87-6	27	SPNEPD-01	9		
GLA02K-HR	18	LEVEL-UN	37	SPNNPD-01	9		
GLA100-01	38	LOCPIN-ZM	41	SPNRNG-01	9		
GLA100-VK	19	LOWCAP-03	34	SPNSHT-13	9		
GLA1CA-01	38	LOWCAP-05	34	SPNSHT-15	9		
GLA200-DK	17	MAGWHT-VK	12	SPNSHT-19	9		
GLA200-VK	19	MSHSCR-20	34	SPNTPD-01	9		
GLA250-01	38	MSHSCR-30	34	STABSK-10	7		
GLA300-01	34	MSHSCR-40	34	STABSK-20	7		
GLA300-02	34	NPD013-01	10	STABSK-40	7		
GLA300-03	34	NPD015-01	10	STABSK-VK8	35		
GLA300-AV	34	NPD016-01	10	SYR020-01	42		
GLA500-01	19	NPD016-02	10	TAATUB-HP	42		
GLA500-DK	17	NPD019-01	10	TACHOM-UN	37		
GLA500-HR	18	PADHLD-12A	11	TEFTUB-8V	42		
GLA900-01	19	PADHLD-16A	11	TEFTUB-HP	42		
GLA900-AC	17	PAP100-01	42	THERMD-LC	37		
GLA900-AD	17	PLA900-01	19	TPD013-01	10		
GLA900-AW	17	PLA900-AD	17	TPD015-01	10		
GLA900-AH	18	PLA900-AH	18	TPD016-01	10		
GLA900-AS	19	PLA900-AP	18	TPD016-02	10		
GLA900-AT	18	PLA900-AV	19	TPD018-01	10		
GLA900-AV	19	PLA900-DK	17	TPD019-01	10		
GLA900-CA	17	PLA900-EW	17	TPP100-01	42		
GLA900-DB	40	PLA900-HR	18	TUBING	42		
GLA900-DK	17	PLA900-PT	18	TUMSCR-DK	10		
GLA900-EW	17	POLSCR-1K	34	TUMSCR-HR	28		
GLA900-HR	18	POLSCR-20	34	UPPCAP-03	34		
GLA900-PT	18	POLSCR-30	34	VALTOL-CUST	37		
GLA900-ST	19	POLSCR-40	34	VALTOL-KT	37		
GLA900-VK	19	PPTUBD-01	42	VESSTD-06A	18		
GLA905-DB	40	PPTUBV-01	42	VESSTD-08A	18		
GLA9AM-VK	19	PPTUBV-02	42	VIBMET-UN	37		
GLA9CR-AD	17	PRBFSR-5S	29	VK600A-CR	19		
GLA9CR-DK	17	PRBFSR-9S	29	VOLFLK-05	38		
GLA9CR-ZM	41	PRBFSR-ST	29	VOLFLK-09	38		
GLA9PK-01	19	PRBNSR-ST	29	VOLFLK-1K	38		

If you cannot find what you need
please contact us

 sales@labhut.com

 +44 (0)1452 310210

 +44 (0)1452 300075



LabHut.com

tablet dissolution accessories

Order online at: www.labhut.com

LabHut.com is an international supplier of chromatography and dissolution products. From our UK headquarters, we currently supply directly to customers in over 60 countries, plus many more locally through our international distributor network!

Quality Products...

At LabHut, we stock top quality products that offer both excellent performance and value for money.

We supply over 4,000 products from a number of innovative manufacturers:

- Dissolution Accessories & Consumables
- Syringe Filters
- Autosampler Vials, Caps, Septa and Inserts
- GC & LC Autosamplers
- HPLC Columns
- Detector Lamps
- HPLC Instruments
- Microtiter Plates
- Chromatography Validation Equipment

... and Customer Service to match!

Not sure if a product is suitable for your application? Need more information? Looking for advice? Then get in contact!

There's more to LabHut than the website! Our experienced and fully qualified team are always on hand to offer advice and answer any questions you may have.

You can contact us by email at sales@labhut.com.

Or phone us on +44 (0)1452 310210.

What's more, we'll still be here and happy to help you after your purchase, ensuring you really get the most from your investment.

www.labhut.com



LabHut.com



TabletDissolution.com is the reference site for SMI-LabHut's range of tablet dissolution instruments and consumables. It runs alongside LabHut.com, which sells the dissolution products.

www.tabletdissolution.com



The dissolution accessories and consumables at LabHut.com are manufactured by **Quality Lab Accessories LLC** (QLA) in Bridgewater, New Jersey, USA.

QLA's experienced engineering staff and manufacturing facility produce the highest quality products that are industry standards.

www.qla-llc.com

Ordering and Product Information

All of the LabHut Tablet Dissolution products can be ordered online at www.labhut.com or by calling +44 (0)1452 310210. They are also available through distributors worldwide. To find your local distributor please visit www.labhut.com/distributors.

All trademarks acknowledged.

Copyright © 2008
SMI-LabHut Ltd
ALL RIGHTS RESERVED

Printed in the UK, February 2008.



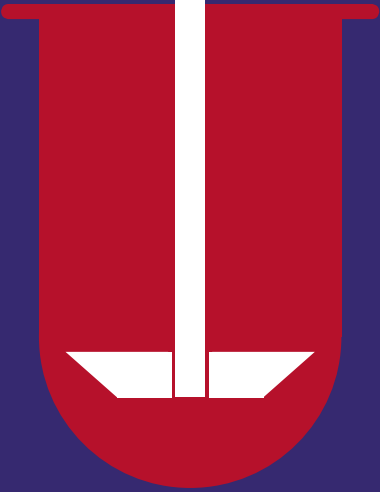
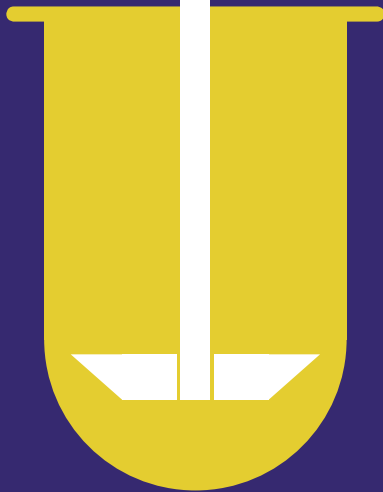
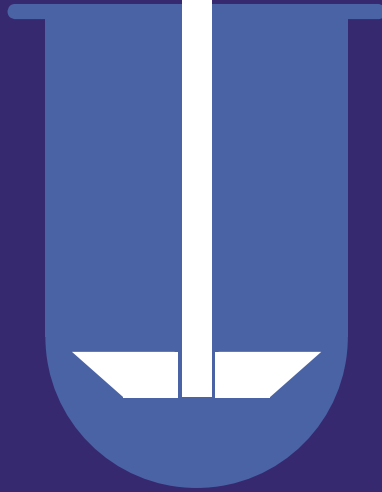
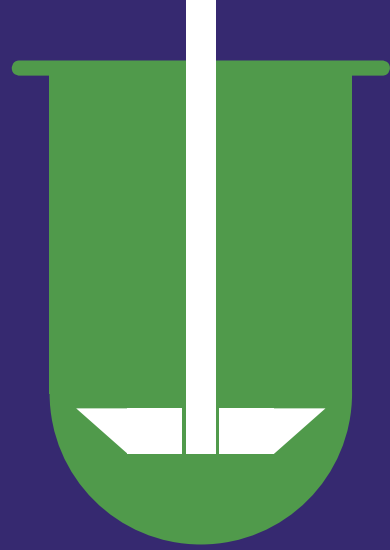

Your Local Distributor:



SMI-LabHut Ltd

SMI-LabHut Ltd

The Granary
The Steadings
Maisemore
Gloucestershire
GL2 8EY
UK

Tel: +44 (0)1452 310210

Fax: +44 (0)1452 300075

Email: sales@labhut.com

Website: www.labhut.com