



ISO
9001:2015

Design, Engineering and Manufacturing

porvair
sciences

Chromatography, Biotechnology, Environmental
and Laboratory Products and Services

Table of Contents

Information

Intro	i
History of Innovation	ii
General Conditions of Sale	iv
Technical Information	v

Chromatography

Standard Opening Crimp Top Vials, 12x32mm, 11mm Crimp Finish	C1	WISP Style Screw Thread, 15x45mm, 13-425mm Neck Finish	C44
Big Mouth Crimp Top Vials, 12x32mm, 11mm Crimp Finish	C5	Shell Vials, 15x45, 15mm Plug	C48
Snap Ring Crimp Top Vials, 12x32mm, 11mm Crimp Finish	C10	Shell Vials for Waters WISP, 8x40mm, 8mm Plug	C50
Snap Seal Vials, Patented, 12x32mm, 11mm Crimp Finish	C16	Dram Vials	C53
Standard Opening Screw Thread Vials, 12x32mm, 8-425mm Neck Finish	C21	Headspace Vials and Accessories	C57
RAM Large Opening Vials, 12x32mm, 9mm Neck Finish	C26	Injection Port GC Septa	C61
Big Mouth Screw Thread Vials, 12x32mm, 10-425mm Neck Finish	C33	Crimpers & Decappers	C65
Shell Vials, 12x32mm, 12mm Plug	C37	Specialty Vials	C68
Versa Vials, 12x32mm, 9mm Opening	C39	Specialty Items	C70
Snap Ring Vials, 15x45, 13mm Crimp Finish	C41		

Biotechnology

96-Well Multi-Tier™ Micro Plate System	B1	Sealing Film for Cell and Tissue Culture, ELISA, EIA, & Similar Assays	B18
Aluminum 96-Well Micro Plate System	B8	Sealing Films for PCR and Cold Storage	B19
Snap Seal™ Vials and Snap Top Caps™ for 96-Well Multi-Tier™ MPS	B10	Molded Sealing Mats for Standard 96-Well Microplates	B24
Snap Seal™ Vials and Snap Top Caps™ for 96-Square Deep Well Microplates	B11	8 and 12 Channel Reservoir Trough Plate for Multi-Channel Pipettors	B26
Glass Inserts and Molded Mats for 96-Square Deep Well Microplates	B12	Polypropylene Plastic Pasteur Pipets	B27
96-Well Plate with Glass Inserts Designed for HTC	B14	Cell Lifter	B28
Sealing Films for 96-Well Microplates	B15	Freezer Boxes	B29

Filters and Membranes

Syringe Filters	F1	SPE	F10
Membrane Filters	F7	QuEChERS	F16

Environmental

VOA Vials - Open Top Closures and Septum	E1	Laboratory Grade Plastic Bottles	E28
Amber Glass Wide Mouth Packers	E11	Narrow Mouth Septum Bottles	E30
Boston Round Glass Bottles	E15	Wide Mouth Septum Jars	E32
Clear Glass Straight Side Wide Mouth Jars - Short and Tall	E21	Wide Mouth Straight Sided Polypropylene Plastic Jars	E34
High Density Polyethylene Wide Mouth Jars	E25	PTFE Cap Liners and Solid Top Closures	E35
High Density Polyethylene Narrow Mouth Jars	E27	Environmental Packaging	E38

Chromatography, Biotechnology and Environmental Products



Our manufacturing operations combine the most modern equipment with our own custom designed machinery and accessories. Specialized, highly automated glass and plastic manufacturing machinery handles volume production while maintaining product integrity. Capable of operating automatically seven days a week and twenty-four hours a day, our molding machinery is designed for quick and easy changeover, making both short and long runs cost effective.

From the annealing ovens to the plastic parts separators, our attention to detail at the initial stage of production assures high quality for all our glass and plastic vials, closures, microplates, and inserts. Produced to meet a wide variety of user specifications, Finneran products maintain their consistency from batch to batch.

ISO Certification

J.G. Finneran Associates has attained ISO-9001:2015 compliance for manufacturing and distribution of its products, as accredited in the United States by the Registrar Accreditation (RAB), and in Europe by the Raad voor Accreditatie (RvA).

CONTACT J.G. FINNERAN ASSOCIATES

3600 Reilly Court
Vineland, NJ 08360
Tel: 856-696-3605
Fax: 856-696-5652
Email: info@jgfinneran.com
www.jgfinneran.com

Founded in 1977 by Jerry and Jo Finneran, J.G. Finneran Associates is an independent, family-owned and operated corporation. Satisfying customer needs is a matter of personal pride at J.G. Finneran. We communicate with the people who use and distribute our products, and we listen to what they have to say. Based on the information they give us, we respond quickly and effectively to problems and new application requirements with efficient and innovative solutions. Our approach has resulted in a host of new designs and patents over the years, establishing J.G. Finneran as a world leader in glass and plastic product design.

As a recognized industry innovator, we offer a complete line of unique proprietary items designed to save our customers time and money. Coupling over a quarter of a century of experience with in-house glass and plastic production facilities, we manufacture and stock our own proprietary items and a variety of standard glass products. Our engineering and design team develops new products and provides continual modifications for existing ones. Efficient support personnel monitor each order to assure product quality, timely delivery, proper technical support, and training on product use.



History of Innovation



1985
100µL Glass/Plastic
LVV with 8mm
Thread and 11mm
Snap Ring™ Finish



1985
100µL Polypropylene
LVV with 8mm
Thread and 11mm
Snap Ring™ Finish



1986
Limited Volume
Inserts with
Bottom Springs



1987
Patented
Capsule
Holder



1989
2.0mL Big Mouth
Vials with 11mm
Crimp Finish



1990
11mm Snap
Top Caps™ and
Polypropylene
Snap Top Caps™
for GC Testing



1990
Patented Top Hat™
Closure Assembly
for 8mm, 13mm
and 24mm Finish



1990
Limited Volume
Inserts with
Patented
Top Springs™



1990
Top Seal™ Closures
for 8mm, 10mm
and 13mm Finish



1991
StepVial
with Step
Inserts



1992
2.0mL Big
Mouth Vials
with 11mm
Snap Ring™ Finish



1993
Ampule
Storage
Holder



1994
8mm PE Snap
Plug Lined
with Silicone



1995
8mm, 12mm and
15mm Starburst
Conical Snap Plugs



1995
Patented Poly
Crimp™ Seal with
11mm and
20mm Finish



1995
Patented 2.0mL
and 4.0mL Snap
Seal™ Vials



1995
Snap Racks™
for 8mm and
12mm vials



1996
Graduated
Marking
Spots for all
Sample Vials



1996
11mm and 13mm
Snap Top Caps™
for Shimadzu
Autosamplers



1997
8mm Snap
Top Caps™



1997
Scallop Packs™
and
Convenience Packs

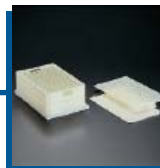

2000
Patented 96-Well
Multi-Tier™
Micro Plate System

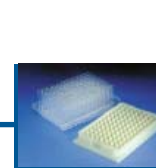

2001
Vial
Loader



2002
2.0mL Glass Versa
Vial™ and 12mm
Versa Vial™ Plug



2002
1.5mL Polypropylene
Versa Vial™



2002
1.5mL Polypropylene
Vial with 8-425mm
Screw Thread, 9mm
Thread and 11mm
Snap Seal™ Finish



2003
Patented 96-Well
Pattern Blue PTFE
Sealing Film, 2mil
and 5mil Thick

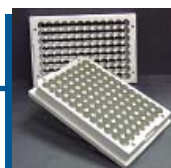

2005
Vented
Aluminum,
96-Well
Base Plate



2006
Patented 12mm x
32mm Vista Vial™
with 8-425mm Screw
Thread, 9mm Thread
and 11mm Snap
Seal™ Finish



2006
Aluminum
Micro Plate
System

History of Innovation



2006
9mm R.A.M.[™]
Interlock[™]
Vial



2008
Vial
Remover



2011
9mm R.A.M.[™]
Vial Assembled
with Conical
or Flat Bottom
Step Insert



2011
8mm Snap Seal[™]
Vials and Snap Top
Caps[™] for 96-Well
Multi-Tier[™] Micro
Plate System



2013
Magnetic
Overcap for
9mm R.A.M.[™]
Closure



2014
Pullpoint
Inserts



2014
6x32mm
Inserts for
High Throughput
Chromatography



2014
Metal
O-Ring
Closures



2014
Black
Product
Series

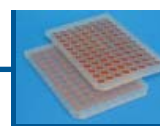

2015
Pierceable
CapMat for
Crimp top
or Flanged
Inserts

Founded in 1977 by Jerry and Jo Finneran, J.G. Finneran Associates is an independent, family-owned and operated corporation. Satisfying customer needs is a matter of personal pride at J.G. Finneran. We communicate with the people who use and distribute our products, and we listen to what they have to say. Based on the information they give us, we respond quickly and effectively to problems and new application requirements with efficient and innovative solutions. Our approach has resulted in a host of new designs and patents over the years, establishing J.G. Finneran as a world leader in glass and plastic product design.

As a recognized industry innovator, we offer a complete line of unique proprietary items designed to save our customers time and money. Coupling over a quarter of a century of experience with in-house glass and plastic production facilities, we manufacture and stock our own proprietary items and a variety of standard glass products. Customer involvement and satisfaction is what we are all about. Our engineering and design team develops new products and provides continual modifications for existing ones. Efficient support personnel monitor each order to assure product quality, timely delivery, proper technical support, and training on product use.

Our manufacturing operations combine the most modern equipment with our own custom designed machinery and accessories. Specialized, highly automated glass and plastic manufacturing machinery handles volume production while maintaining product integrity. Capable of operating automatically seven days a week and twenty-four hours a day, our molding machinery is designed for easy, quick changeover, making both short and long runs cost effective.

From the annealing ovens to the plastic parts separators, our attention to detail at the initial stage of production assures high quality for all our glass and plastic vials, closures, microplates, and inserts. Produced to meet a wide variety of user specifications, Finneran products maintain their consistency from batch to batch.

General Conditions of Sale

ORDERING INFORMATION

Orders are taken by:

Telephone: 1-856-696-3605

Fax: 1-856-696-9002

E-mail: customerservice@jgfinneran.com

*When ordering please specify catalogue numbers, quantity and description. A purchase order is required for all orders.
If a CONFIRMING order is sent, please mark clearly "CONFIRMING" to avoid duplication.*

MINIMUM ORDERS

Minimum orders on any standard product offered in the Price List, is the case quantity. We also require a minimum order on any specially designed products or any other non-standard item. J.G. Finneran Associates, Inc. reserves the right to under run or overrun any special order up to 10% of the ordered quantity.

VOLUME DISCOUNT PRICING

J.G. Finneran Associates, Inc. offers volume discount pricing on a large variety of items. Volume shipments must be scheduled and taken within a specific time frame. Volume pricing is valid for a limited time and must be re-quoted after time expiration. Customers must comply with J.G. Finneran Associates, Inc. payment terms in order to qualify for volume discount pricing.

SHIPPING/DELIVERY

We make every effort to fill orders promptly. However, certain items may not always be in stock for immediate shipment. In the event that a complete shipment cannot be made, we reserve the right to make partial shipments, unless otherwise specified. Normal method of domestic shipment is by United Parcel Service (UPS) ground service, 2nd Day Air and Next Day Air. Methods of international shipments include UPS Express, UPS Expedited, Freight Forwarders and Sea Freight or as indicated by the customer. We are also served by Federal Express and other trucking firms. Freight and insurance charges will be prepaid and added to the invoice.

TERMS OF PAYMENT

Our terms are net 30 days from the invoice date for established accounts only. All items are shipped F.O.B., Vineland New Jersey. For invoices not paid within 30 days, a service charge of 1.5 percent per month will be charged.

EXPORT ORDERS

Freight terms are Ex-works. All prices are in US Dollars. Payment in Advance of shipping is required on all export orders, unless other arrangements are made. Payment may be made by wire transfer or credit card. Other payment options may be available, please contact J.G. Finneran Associates.

RETURNS

Prior approval, at the discretion of J.G. Finneran Associates, Inc., is required before returning a product. Products returned for credit that do not involve a quality issue will be credited at the original invoice price less a restocking fee. Transportation charges shall be paid by the customer. Special order items are non-returnable. Product must be returned in saleable condition (no open packages, no labels, no obsolete inventory, etc.).

ORDER DISCREPANCY

Advise Quality Assurance of any shortage or discrepancy within 3 days of receipt of shipment. Prior to contacting Quality Assurance, recheck package contents against the packing list to verify item(s) have not been backordered. Carefully re-inspect all packaging material(s) for small items which may have been overlooked during unpacking.

CLAIM/DAMAGED GOODS

Damaged or loss claims should be reported immediately and directly to the carrier. The shipping container should be kept until a representative from the shipping company checks the claim.

PRODUCT WARRANTY/LIABILITY LIMITS

J.G. Finneran Associates, Inc. warrants its products to comply with stipulated quality standards and performance capabilities. The products are not warranted, nor does Finneran assume liability for misuse – use of products for which they were not intended. Furthermore, the warranty only extends to products that are wholly comprised of Finneran components. The cost of the product is the most liability which Finneran will assume for breach of warranty.

J.G. FINNERAN ASSOCIATES, INC.

TRADEMARKED & PATENTED PRODUCTS

96-Well Multi-Tier™ Micro Plate System (Patented)

Capsule Holders™ (Patented)

Graduated Vial™

Interlocked™ Vial/Insert

Poly Crimp™ Seal (Patented)

R.A.M.™ Vial

Scallop Pack™

Snap Rack™

Snap Ring™ Vial

Snap Seal™ Vial (Patented)

Snap Top Cap™

Top Seal™ Closure

Top Hat™ (Patented)

Top Spring™ Insert (Patented)

Versa Vial™

Versa Vial™ Plug

Vista Vial™

CHANGES

J.G. Finneran Associates, Inc. reserves the right to change product specifications, quantities, designs or prices without notice and without liability for such changes.

Technical Information

Vial Finish Specifications

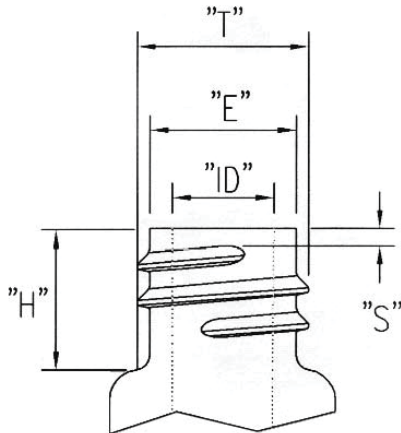

Standard Screw Thread Finish

Definitions

- "T" = Outer diameter of the thread
- "E" = Inside diameter of the thread
- "ID" = Inside diameter
- "S" = Start of thread
- "H" = Distance from top of finish to shoulder for closure clearance

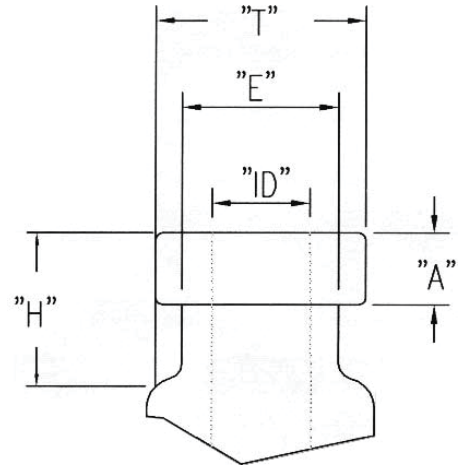

Standard Crimp Seal Finish

Definitions

- "T" = Outer diameter of the thread
- "E" = Inside diameter of the thread
- "ID" = Inside diameter
- "S" = Start of thread
- "H" = Distance from top of finish to shoulder for closure clearance

Screw Thread Finishes

GPI refers to the "Glass Packaging Institute."

The GPI is responsible for establishing and issuing standards for the types and finishes produced by American glass manufacturers.

For example, an 8-425 neck finish is approximately 8mm in diameter across the outside of the threads.

The 425 represents the finish (style of thread).

Typical GPI finishes found in the chromatography field are as follows:

8-425 Closure - Varian, Shimadzu

10-425 Closure - Waters Alliance 2690

13-425 Closure - Waters 48 position WISP™, Shimadzu

Note: 9mm thread finish does not appear in the GPI finishes. It is not a standard finish. The 9mm closure and vial are used with Agilent equipment.

Glass Technical Information

Terminology

Borosilicate - A glass that is high in silicate and having at least 5% boron oxide.

Linear Coefficient of Expansion - Fractional change in length of glass per degree change in temperature.

Strain Point - Maximum temperature to which glass should be heated during use.

Type of Glass

USP Type - Pharmaceutical glass containers can be classified as USP Type I, II, III or NP.

Type I - Borosilicate glass represents the least reactive glass. Type I glass has the least pH shift. (Lowest leaching characteristics)

Coefficient of Expansion = 33 or 51 for Clear and 51 for Amber

Type III - soda lime glass - cannot be autoclaved.

Type NP - general purpose soda-lime glass used where chemical durability and heat shock are not factors.

Coefficient of Expansion = 92

Technical Information

Ions	Type I Clear (33)	Type I Amber (51)
Na	0.3 - 0.5	0.4 - 1.4
K	ND*	ND - 0.02
Ca	ND	ND - 0.1
Mg	ND	ND
Al	ND	ND - 0.5
Fe	ND	ND
Ba	ND	ND - 0.02
Zn	ND	
Mn	ND	ND
Si	ND	ND - 5

Color	Clear	Amber
Linear Coefficient of Expansion	33	51
Strain Point (Degrees Celsius)	515	535
USP Class Type	Type I	Type I
Light Protection	No	Yes

Results in µg/mL

*Non detectable

PLASTIC PROPERTIES

Type of Plastic	LDPE	HDPE	PP	PMP	PS
Max. use temperature, C/F	80°C/176°F	120°C/248°F	135°C/275°F	175°C/347°F	90°C/194°F
Transparency	Translucent	Translucent	Translucent	Clear	Clear
Sterilization					
Autoclaving	No	No	Yes	Yes	No
Disinfectants	Yes	Yes	Yes	Yes	No
Dry Heat	No	No	No	Yes	No
Radiation	Yes	Yes	No*	No	Yes
Specific Gravity	0.92	0.95	0.90	0.83	1.05
Flexibility**	Good	Rigid	Rigid	Rigid	Rigid

Note: Chart is general guideline only.

* = Some radiation resistant polypropylene resins available.

**Flexibility = Depends on thickness.

SEPTA SELECTION GUIDE

Materials	Compatibility	Incompatibility	PP
Silicone	Alcohols, acetone, ether, DMF, DMSO	ACN, THF, chloroform, pyridine, benzene, toluene, hexane, heptane	VERY GOOD
PTFE/Silicone PTFE/Silicone/PTFE	PTFE resistance until punctured, then septa or liner will have silicone compatibility		VERY GOOD VERY GOOD
Rubber (Natural Butyl)	ACN, Acetone, DMF, alcohols, Diethylamine, DMSO, Phenol	Chlorinated solvents, aromatics, hydrocarbons, carbon disulfide	EXCELLENT
Natural PTFE/Natural Rubber Butyl Rubber/PTFE	PTFE resistance until punctured, then septa or liner will have rubber compatibility		VERY GOOD VERY GOOD
Viton	Chlorinated solvents, benzene, toluene, alcohols, hexane, heptane	DMF, DMSO, ACN, THF, pyridine dioxidane, methanol, acetone	VERY GOOD

v

Standard Opening Crimp Top Vials, 12x32mm, 11mm Crimp Finish

Finneran Products Certified For Science™

Vials



32011E-1232A, 32011E-1232



30211M-1232A, 30211M-1232

Neck finish allows use of patented Poly Crimp™ Seals or standard aluminum seals. Designed to work in Agilent and other autosamplers. Choose from clear or amber Type I borosilicate glass. Available with graduated marking spots.

Shelf Pack - 100 pieces; Case Pack - 1000 pieces

Cat. No.	Description
32011-1232	2.0mL Clear Vial
32011-1232A	2.0mL Amber Vial
32011-1232Z	2.0mL Clear Vial, Silanized
32011-1232AZ	2.0mL Amber Vial, Silanized
32011E-1232	2.0mL Clear Vial, White Graduation Spot
32011E-1232A	2.0mL Amber Vial, White Graduation Spot

Limited Volume Interlocked™ Standard Crimp Top Vials

The Finneran Interlocked™ Vial is composed of a 12x32 glass vial and a clear glass limited volume insert fused together. This design eliminates movement of the insert, allows more consistent sample recovery, eliminates needle damage and concerns about contaminants around the fused seam/space between the neck of the vial and the insert. Available with marking spots.

Case Pack - 100 pieces

Cat. No.	Description
30211-1232	100µL Clear Interlocked™ Vial/Insert
30211-1232A	100µL Amber Interlocked™ Vial/Insert
30211M-1232	100µL Clear Interlocked™ Vial/Insert with Marking Spot
30211M-1232A	100µL Amber Interlocked™ Vial/Insert with Marking Spot

Interlocked™ Vials are also available Silanized

Closures

Poly Crimp™ Seals - eliminates the need for crimpers and decappers

Poly Crimp™ Seals - Patented

The Finneran patented polypropylene Poly Crimp™ seal fits virtually any 12x32mm sample vial with a crimp style finish. The Poly Crimp™ seal snaps on and off with crimping being an option for a tighter seal. Poly Crimp™ seals are available in a variety of colors for easy sample identification.

Shelf Pack - 100 pieces; Case Pack - 1000 pieces

Cat. No.	Description
5500-11*	11mm Clear Poly Crimp™ Seal, w/Molded Septum
5500SB-11*	11mm Clear Poly Crimp™ Seal, w/Starburst
5510-11*	11mm Clear Poly Crimp™ Seal, w/10mil PTFE
5517-11*	11mm Clear Poly Crimp™ Seal, w/10mil PTFE w/Slit
5540-11*	11mm Clear Poly Crimp™ Seal, Clear PTFE/Butyl Rubber
5550-11*	11mm Clear Poly Crimp™ Seal, PTFE/Silicone
5560-11*	11mm Clear Poly Crimp™ Seal, PTFE/Silicone/PTFE
5570-11*	11mm Clear Poly Crimp™ Seal, PTFE/Silicone w/Slit
5581-11*	11mm Clear Poly Crimp™ Seal, PTFE/Silicone w/Starburst

* Available in additional colors; (B) Blue, (G) Green, (R) Red, & (Y) Yellow



Standard Opening Crimp Top Vials, 12x32mm, 11mm Crimp Finish

Closures



Aluminum Seals, Lined

Made of the highest quality aluminum; for use with standard 11mm chromatography vials. The open top allows for filling and retrieving samples with a syringe. Seals are available in a variety of colors for easy sample identification.

Shelf Pack - 100 pieces; Case Pack - 1000 pieces

Cat. No.	Description
5110-11*	11mm Silver Seal, 10mil PTFE
5120-11	11mm Silver Seal, 10mil Polypropylene
5140-11*	11mm Silver Seal, Clear PTFE/Red Rubber
5140-11X*	11mm Silver Seal, Clear PTFE/Natural Red Rubber
5141-11	11mm Silver Seal, Clear PTFE/Butyl Rubber
5150-11*	11mm Silver Seal, PTFE/Silicone
5160-11*	11mm Silver Seal, PTFE/Silicone/PTFE
5170-11	11mm Silver Seal, PTFE/Silicone w/Slit
5190-11	11mm Silver Seal, Black Viton*

* Available in additional colors; (B) Blue, (G) Green, (R) Red, & (Y) Gold



11mm Magnetic Seals

Magnetic seals for use with instruments (CTC Analytics PAL) transporting the vials using magnets.

Shelf Pack - 100 pieces; Case Pack - 1000 pieces

Cat. No.	Description
5140M-11	11mm Silver Magnetic Seal, PTFE/Red Rubber
5150M-11	11mm Silver Magnetic Seal, PTFE/Silicone
5160M-11	11mm Silver Magnetic Seal, PTFE/Silicone/PTFE

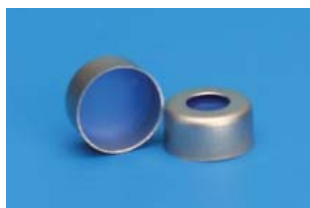

5150UL-11

11mm Aluminum Seals – Ultra Low Bleed Septa

Finneran's Ultra Low Bleed Aluminum Seals are lined using a LCMS high purity septa. Ideal for very sensitive applications such as Mass Spec or when multiple injections are required. Our Ultra Low Bleed Seals eliminate particulates with no interfering peaks.

Shelf Pack - 100 pieces; Case Pack - 1000 pieces

Cat. No.	Description
5150UL-11*	11mm Silver Seal, 1mm Thick Clear PTFE/Blue Silicone Septa

* Available in additional colors; (B) Blue, (G) Green, (R) Red, & (Y) Gold

Convenience Packs



Convenience Packs

Components packaged in a clear lid tray. Fits into bench drawer for easy access, and packaging keeps products visible and particle free.

Shelf Pack - 100 pieces; Case Pack - 1000 pieces

Cat. No.	Description
920514-12	Clear Vial, 11mm Silver Seal, Clear PTFE/Red Rubber
920514-12A	Amber Vial, 11mm Silver Seal, Clear PTFE/Red Rubber

Any combination of vial and closure is available. Please call.

Standard Opening Crimp Top Vials, 12x32mm, 11mm Crimp Finish

Limited Volume Inserts

All Glass Inserts are available Silanized.



401-530, 401-531, 4015BS-529



402FT-531



401CP-530, 401P-530, 401PBS-530



4025P-531, 4025-531, 4025-531ID

Conical Glass Inserts - Precision-Formed Mandrel Interior

Inserts are available preassembled with a polymer bottom spring. The polymer spring acts as a shock absorber that protects against breakage if the needle bottoms out. The conical design permits complete sample removal.

Case Pack - 100 pieces

Cat. No.	Description
4005BS-425	50µL Glass Insert with Bottom Spring
401BS-530	100µL Glass Insert with Bottom Spring
401-530	100µL Glass Insert, No Spring
401-531	200µL Glass Insert, No Spring
4015BS-529	150µL Glass Insert with Bottom Spring

Conical Glass Inserts - Pulled Point Interior

Shelf Pack - 100 pieces; Case Pack - 1000 pieces

Cat. No.	Description
402FT-531	200µL Glass Conical Limited Volume Insert, No Spring

Conical Polypropylene Inserts - Precision-Formed Interior

Shelf Pack - 100 pieces; Case Pack - 1000 pieces

Cat. No.	Description
401CP-530	100µL Clear Polypropylene Insert, No Spring
401CPBS-530	100µL Clear Polypropylene Insert with Bottom Spring
401P-530	100µL Polypropylene Insert, No Spring
401PBS-530	100µL Polypropylene Insert with Bottom Spring

Flat Bottom Glass and Polypropylene Inserts

Shelf Pack - 100 pieces; Case Pack - 1000 pieces

Cat. No.	Description
4025-531	250µL Glass Flat Bottom Insert
4025-531ID	250µL Glass Flat Bottom Insert with ID Ring
4025P-531	250µL Polypropylene Flat Bottom Insert

Standard Opening Crimp Top Vials, 12x32mm, 11mm Crimp Finish

Accessories



Crimpers/Decappers for 11mm Crimp Vials

J.G. Finneran Crimpers and Decappers are designed, and manufactured using quality materials, and finishing techniques to provide a consistent and dependable seal while maintaining their durability, and long life. The standard hand crimpers are provided with an adjustable stop, allowing the operator to repeatedly achieve a quality crimped seal. All parts that contact the crimp seal are stainless steel or plated. The crimper jaws are hardened and polished to provide smooth, consistent operation.

Sold Individually

Cat. No.	Description
9300-11	11mm Hand Operated Crimper
9300-11SS	11mm Hand Operated Crimper, Stainless Steel
9306-11SS	11mm Hand Operated Crimper, Stainless Steel w/Grips
9310-11	11mm Hand Operated Decapper (Plier Style)
9320-11	11mm Crimp Type Decapper
9320-11SS	11mm Hand Operated Decapper, Stainless Steel
9326-11SS	11mm Hand Operated Decapper, Stainless Steel w/Grips



Snap Racks™

Snap Racks™ are constructed of durable glass reinforced polypropylene, with a center well to conveniently hold caps, seals, septa, etc. Racks snap together securely to double your rack capacity.

Case Pack - 5 pieces

Cat. No.	Description
9700-12	50 Position White Rack for 12mm Vials
9700-12B	50 Position Blue Rack for 12mm Vials



Multi-Use Universal Vial Rack™ System

Increased spacing allows the user to pipet samples or attach caps without removing the vials from the rack. Frame is made of glass-reinforced polypropylene and insert trays are made of transparent PETG.

Case Pack - 5 pieces

Cat. No.	Description
9600-01	Universal Vial Rack™, Blue Polypropylene, for Insert Trays
9601-12	25 Position Insert Tray for Universal Vial Rack™ for 12mm Vials

Big Mouth Crimp Top Vials, 12x32mm, 11mm Crimp Finish

Finneran Products Certified For Science™

Vials



32011L-1232A, 32011L-1232,
3211LE-1232A, 32011LE-1232



32511L-1240



31111L-1232



31511-1232



30211L-1232, 30211L-1232A,
30211LM-1232, 3021LM-1232A

40% larger opening prevents broken needles due to increased target area. Neck finish allows use of patented Poly Crimp™ Seals or standard aluminum seals. Designed to work in Agilent and other autosamplers. Choose from clear or amber Type I borosilicate glass. ID design incorporates the StepVial feature that precisely centers a limited volume insert in the vial neck. Available with graduated marking spots.

Shelf Pack - 100 pieces; Case Pack - 1000 pieces

Cat. No.	Description
32011L-1232	2.0mL Clear Vial
32011L-1232A	2.0mL Amber Vial
32011L-1232Z	2.0mL Clear Vial, Silanized
32011L-12AZ	2.0mL Amber Vial, Silanized
32011LE-1232	2.0mL Clear Vial, White Graduation Spot
3211LE-1232A	2.0mL Amber Vial, White Graduation Spot

The 2.5mL large opening vial has the same attributes of the large opening vial but with a larger volume capacity. The added height allows for vial to be used in equipment without a closure. Manufactured from Type I borosilicate, 1st hydrolytic class clear glass, the 12x40mm vial works with the Finneran patented 11mm Poly Crimp™ Seal.

Shelf Pack - 100 pieces; Case Pack - 1000 pieces

Cat. No.	Description
32511L-1240	2.5mL Clear Vial, 12x40mm

Limited Volume Big Mouth Crimp Top Vials

Tapered Bottom Vials - Manufactured from Type I borosilicate clear glass. The tapered bottom allows for the concentration of samples into the tip by solvent evaporation.

Case Pack - 100 pieces

Cat. No.	Description
31111L-1232	1.1mL Clear Tapered Bottom Vial
	Also available Silanized

High Recovery Vials - High recovery vial is a one piece glass vial with a conical bottom designed for complete sample recovery.

Case Pack - 100 pieces

Cat. No.	Description
31511-1232	1.5mL Clear High Recovery Vial
31511-1232A	1.5mL Amber High Recovery Vial
	Also available Silanized

Limited Volume Interlocked™ Big Mouth Crimp Top Vials

The Finneran Interlocked™ Vial is composed of a 12x32 glass vial and a clear glass limited volume insert fused together. This design eliminates movement of the insert, allows more consistent sample recovery, eliminates needle damage and concerns about contaminants around the fused seam/space between the neck of the vial and the insert. Available with marking spots.

Case Pack - 100 pieces

Cat. No.	Description
30211L-1232	300µL Clear Interlocked™ Vial/Insert
30211L-1232Z	300µL Clear Interlocked™ Vial/Insert - Silanized
30211L-1232A	300µL Amber Interlocked™ Vial/Insert
30211L-12AZ	300µL Amber Interlocked™ Vial/Insert - Silanized
30211LM-1232	300µL Clear Interlocked™ Vial/Insert with Marking Spot
3021LM-1232A	300µL Amber Interlocked™ Vial/Insert with Marking Spot

Big Mouth Crimp Top Vials, 12x32mm, 11mm Crimp Finish

Closures

Using Patented Poly Crimp™ seals, in place of aluminum seals, eliminates the need for crimpers and decappers

Poly Crimp™ Seals - Patented

The Finneran patented polypropylene Poly Crimp™ seal fits virtually any 12x32mm sample vial with a crimp style finish. The Poly Crimp™ seal snaps on and off with crimping being an option for a tighter seal. Poly Crimp™ seals are available in a variety of colors for easy sample identification.

Shelf Pack - 100 pieces; Case Pack - 1000 pieces

Cat. No.	Description
5500-11*	11mm Clear Poly Crimp™ Seal, w/Molded Septum
5500SB-11*	11mm Clear Poly Crimp™ Seal, w/Starburst
5510-11*	11mm Clear Poly Crimp™ Seal, w/10mil PTFE
5517-11*	11mm Clear Poly Crimp™ Seal, w/10mil PTFE w/Slit
5540-11*	11mm Clear Poly Crimp™ Seal, Clear PTFE/Butyl Rubber
5550-11*	11mm Clear Poly Crimp™ Seal, PTFE/Silicone
5560-11*	11mm Clear Poly Crimp™ Seal, PTFE/Silicone/PTFE
5570-11*	11mm Clear Poly Crimp™ Seal, PTFE/Silicone w/Slit
5581-11*	11mm Clear Poly Crimp™ Seal, PTFE/Silicone w/Starburst

* Available in additional colors; (B) Blue, (G) Green, (R) Red, & (Y) Yellow



Aluminum Seals, Lined

Made of the highest quality aluminum; for use with standard 11mm chromatography vials. The open top allows for filling and retrieving samples with a syringe. Seals are available in a variety of colors for easy sample identification.

Shelf Pack - 100 pieces; Case Pack - 1000 pieces

Cat. No.	Description
5110-11*	11mm Silver Seal, 10mil PTFE
5120-11	11mm Silver Seal, 10mil Polypropylene
5140-11*	11mm Silver Seal, Clear PTFE/Red Rubber
5140-11X*	11mm Silver Seal, Clear PTFE/Natural Red Rubber
5141-11	11mm Silver Seal, Clear PTFE/Butyl Rubber
5150-11*	11mm Silver Seal, PTFE/Silicone
5160-11*	11mm Silver Seal, PTFE/Silicone/PTFE
5170-11	11mm Silver Seal, PTFE/Silicone w/Slit
5190-11	11mm Silver Seal, Black Viton® Lined

* Available in additional colors; (B) Blue, (G) Green, (R) Red, & (Y) Gold



11mm Magnetic Seals

Magnetic seals for use with instruments (CTC Analytics PAL) transporting the vials using magnets.

Shelf Pack - 100 pieces; Case Pack - 1000 pieces

Cat. No.	Description
5140M-11	11mm Silver Magnetic Seal, PTFE/Red Rubber
5150M-11	11mm Silver Magnetic Seal, PTFE/Red Silicone
5160M-11	11mm Silver Magnetic Seal, PTFE/Silicone/PTFE



Big Mouth Crimp Top Vials, 12x32mm, 11mm Crimp Finish

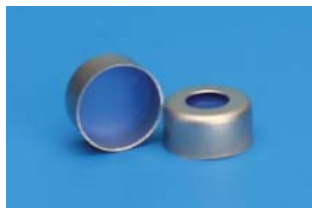

5150UL-11

11mm Aluminum Seals – Ultra Low Bleed Septa

The Finneran's Ultra Low Bleed Aluminum Seals are lined using a LCMS high purity septa. Ideal for very sensitive applications such as Mass Spec or when multiple injections are required. Our Ultra Low Bleed Seals eliminate particulates with no interfering peaks.

Shelf Pack - 100 pieces; Case Pack - 1000 pieces

Cat. No.	Description
5150UL-11*	11mm Silver Seal, 1mm Thick Clear PTFE/Blue Silicone Septa

* Available in additional colors; (B) Blue, (G) Green, (R) Red, & (Y) Gold

Limited Volume Inserts

All Glass Inserts are available Silanized.



4005BS-625, 401TS-529, 4025-629, 4025BS-629

Conical Glass Inserts - Precision-Formed Mandrel Interior

Inserts are available preassembled with a polymer bottom spring or patented Top Spring™. The polymer spring acts as a shock absorber that protects against breakage if the needle bottoms out. The conical design permits complete sample removal.

Case Pack - 100 pieces

Cat. No.	Description
4005BS-625	50µL Glass Big Mouth Insert with Bottom Spring
401TS-529	100µL Glass Insert with Patented Top Spring™
4025-629	250µL Glass Big Mouth Insert, No Spring
4025BS-629	250µL Glass Big Mouth Insert with Bottom Spring
4025GF-631	250µL Glass Big Mouth Step Insert with Glass Flange



4025FT-631, 4025BSFT-629

Conical Glass Inserts - Pulled Point Interior

Shelf Pack - 100 pieces; Case Pack - 1000 pieces

Cat. No.	Description
4025BSFT-629	250µL Glass Big Mouth Insert, with Bottom Spring
4025FT-631	250µL Glass Big Mouth Insert, No Spring

Conical Polypropylene Inserts - Precision-Formed Interior

Shelf Pack - 100 pieces; Case Pack - 1000 pieces

Cat. No.	Description
401PTS-530	100µL Polypropylene Insert with Patented Top Spring™
4025P-631	250µL Polypropylene Big Mouth Insert, No Spring
4025P-631BK	250µL Black Polypropylene Big Mouth Insert, No Spring
4025PBS-631	250µL Polypropylene Big Mouth Insert w/Bottom Spring
425PBS-631BK	250µL Black Polypropylene Big Mouth Insert w/Bottom Spring
4025PF-631	250µL Polypropylene Step Insert with Plastic Flange



401PTS-530, 4025P-631, 4025P-631BK, 4025PBS-631, 4025PF-631, 425PBS-631BK

Flat Bottom Glass and Polypropylene Inserts

Shelf Pack - 100 pieces; Case Pack - 1000 pieces

Cat. No.	Description
4035-630	350µL Glass Flat Bottom Insert
4035-630ID	350µL Glass Flat Bottom Insert w/ID Ring
4035P-630	350µL Polypropylene Flat Bottom Insert
4035-631	350µL Glass Flat Bottom Insert
4035-631ID	350µL Glass Flat Bottom Insert w/ID Ring

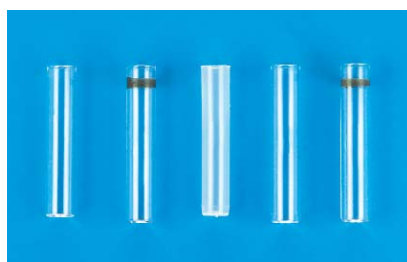

4035-630, 4035-630ID, 4035P-630, 4035-631, 4035-631ID

Big Mouth Crimp Top Vials, 12x32mm, 11mm Crimp Finish

Convenience Packs



Convenience Packs

Components packaged in a clear lid tray. Fits into bench drawer for easy access, and packaging keeps products visible and particle free.

Shelf Pack - 100 pieces; Case Pack - 1000 pieces

Cat. No.	Description
920514L-12	Clear Vial, Silver Seal, Clear PTFE/Red Rubber
920514L-12A	Amber Vial, Silver Seal, Clear PTFE/Red Rubber
920514LE-12	Clear Vial w/Graduated Spot, Silver Seal, Clear PTFE/Red Rubber
92514LE-12A	Amber Vial w/Graduated Spot, Silver Seal, Clear PTFE/Red Rubber
920515L-12	Clear Vial, Silver Seal, Clear PTFE/Silicone
920515L-12A	Amber Vial, Silver Seal, Clear PTFE/Silicone
920515LE-12	Clear Vial w/Graduated Spot, Silver Seal, Clear PTFE/Silicone
920515LE-12A	Amber Vial w/Graduated Spot, Silver Seal, Clear PTFE/Silicone
920516L-12	Clear Vial, Silver Seal, Clear PTFE/Silicone/PTFE
920516L-12A	Amber Vial, Silver Seal, Clear PTFE/Silicone/PTFE
920516LE-12A	Amber Vial w/Graduated Spot, Silver Seal, Clear PTFE/Silicone/PTFE
920517LE-12	Clear Vial w/Graduated Spot, Silver Seal, Clear PTFE/Silicone w/Slit

Any combination of vial and closure is available. Please call.

Accessories



Crimpers/Decappers for 11mm Crimp Vials

J.G. Finneran Crimpers and Decappers are designed, and manufactured using quality materials, and finishing techniques to provide a consistent and dependable seal while maintaining their durability, and long life. The standard hand crimpers are provided with an adjustable stop, allowing the operator to repeatedly achieve a quality crimped seal. All parts that contact the crimp seal are stainless steel or plated. The crimper jaws are hardened and polished to provide smooth, consistent operation.

Sold Individually

Cat. No.	Description
9300-11	11mm Hand Operated Crimper
9300-11SS	11mm Hand Operated Crimper, Stainless Steel
9306-11SS	11mm Hand Operated Crimper, Stainless Steel w/Grips
9310-11	11mm Hand Operated Decapper
9320-11	11mm Crimp Type Decapper
9320-11SS	11mm Hand Operated Decapper, Stainless Steel
9326-11SS	11mm Hand Operated Decapper, Stainless Steel w/Grips



Snap Racks™

Snap Racks™ are constructed of durable glass reinforced polypropylene, with a center well to conveniently hold caps, seals, septa, etc. Racks snap together securely to double your rack capacity.

Case Pack - 5 pieces

Cat. No.	Description
9700-12	50 Position White Rack for 12mm Vials
9700-12B	50 Position Blue Rack for 12mm Vials

Big Mouth Crimp Top Vials, 12x32mm, 11mm Crimp Finish

Multi-Use Universal Vial Rack™ System



Increased spacing allows the user to pipet samples or attach caps without removing the vials from the rack. Frame is made of glass-reinforced polypropylene and insert trays are made of transparent PETG.

Case Pack - 5 pieces

Cat. No.	Description
9600-01	Universal Vial Rack™, Blue Polypropylene, for Insert Trays
9601-12	25 Position Insert Tray for Universal Vial Rack™ for 12mm Vials

Snap Ring™/Crimp Top Vials, 12x32mm, 11mm Crimp Finish

Finneran Products Certified For Science™

Vials



32011S-1232A, 32011S-1232,
3211SE-1232A, 32011SE-1232

Neck finish allows use of Snap Top Caps™, patented Poly Crimp™ Seals or standard aluminum seals. Snap Ring™ finish eliminates the need for crimping or decapping. Designed to work in Agilent and other autosamplers. Choose from clear or amber Type I borosilicate glass. ID design incorporates the Step Vial feature that precisely centers a limited volume insert in the vial neck. Available with graduated marking spots.

Shelf Pack - 100 pieces; Case Pack - 1000 pieces

Cat. No.	Description
32011S-1232	2.0mL Clear Vial
32011S-1232A	2.0mL Amber Vial
32011S-1232Z	2.0mL Clear Vial, Silanized
3211S-1232AZ	2.0mL Amber Vial, Silanized
32011SE-1232	2.0mL Clear Vial, White Graduation Spot
3211SE-1232A	2.0mL Amber Vial, White Graduation Spot



30111G-1232A, 30111G-1232

Limited Volume Snap Ring™/Crimp Top Vials

J. G. Finneran is the original designer and manufacturer of the Glass Insert/Plastic Vial (Glastic). The Finneran Glastic Vial is a unique combination of Type I low extractable borosilicate glass insert and clear or amber thermoplastic polymer outer vial shell. The glass is the only contact between the sample and the seal.

Glastic - Glass Insert/Plastic Outside Vials

Case Pack - 100 pieces

Cat. No.	Description
30111G-1232	100µL - 300µL Glass/Clear Plastic LVV
30111G-1232A	100µL - 300µL Glass/Amber Plastic LVV
30611G-1232	600µL Glass/Clear Plastic LVV



30211SM-1232



30211S-1232A

The Finneran Interlocked™ Vial is composed of a 12x32 glass vial and a clear glass limited volume insert fused together. This design eliminates movement of the insert, allows more consistent sample recovery, eliminates needle damage and concerns about contaminants around the fused seam/space between the neck of the vial and the insert. Available with marking spots.

Interlocked™ Vials

Case Pack - 100 pieces

Cat. No.	Description
30211S-1232	300µL Clear Interlocked™ Vial/Insert
30211S-1232A	300µL Amber Interlocked™ Vial/Insert
30211SM-1232	300µL Clear Interlocked™ Vial/Insert with Marking Spot
3021SM-1232A	300µL Amber Interlocked™ Vial/Insert with Marking Spot

Also available Silanized



80211S-1232, 80211S-1232A

Pre-Assembled Snap Ring™/Crimp Top Vials with Step Insert

The Step Insert precisely sits in the neck of the vial, thus eliminating the need for metal or plastic springs.

Case Pack - 100 pieces

Cat. No.	Description
80211S-1232	Clear Step Snap Ring™/Crimp Vial w/250µL Glass Insert
80211S-1232A	Amber Step Snap Ring™/Crimp Vial w/250µL Glass Insert

Snap Ring™/Crimp Top Vials, 12x32mm, 11mm Crimp Finish

Vials



30111P-1232, 30111T-1232, 30111CP-1232



30711P-12BK

30711P-1232A

Closures



Polypropylene and TPX Snap Ring™/Crimp Top Vials

Amber polypropylene adds protection for light sensitive samples. Black polypropylene protects light sensitive samples from having a chemical reaction during sampling, testing, storage, or transport.

Shelf Pack - 100 pieces; Case Pack - 1000 pieces

Cat. No.	Description
30111P-1232	100µL - 300µL Polypropylene LVV
30111P-1232A	100µL - 300µL Amber Polypropylene LVV
30111P-12BK	100µL - 300µL Black Polypropylene LVV
30111CP-1232	100µL - 300µL Clear Polypropylene LVV
30111T-1232	100µL - 300µL TPX (Polymethylpentene) LVV
30511P-1232	500µL Polypropylene LVV
30511P-1232A	500µL Amber Polypropylene LVV
30511CP-1232	500µL Clear Polypropylene LVV
30511T-1232	500µL TPX (Polymethylpentene) LVV
30711CP-1232	750µL Clear Polypropylene LVV
30711P-1232	750µL Polypropylene LVV
30711P-1232A	750µL Amber Polypropylene LVV
30711P-12BK	750µL Black Polypropylene LVV
30711T-1232	750µL TPX (Polymethylpentene) LVV

Snap Top Caps™

Caps may be snapped on and off by hand which eliminates the need for metal crimping and decapping tools, thus reducing potential hazards due to sharp aluminum metal edges. Large opening top provides greater target area for needle penetration. Available in a variety of colors for easy sample identification.

Shelf Pack - 100 pieces; Case Pack - 1000 pieces

Cat. No.	Description
5200-11*	11mm Clear Snap Cap Seal, w/Molded Septum
520070-11	11mm Clear Snap Cap Seal, w/Molded Septum, Pre-Slit
5200SB-11*	11mm Clear Snap Cap Seal, w/Starburst
5210-11*	11mm Clear Snap Cap, 10mil PTFE
5240-11*	11mm Clear Snap Cap, PTFE/Butyl Rubber
5250-11*	11mm Clear Snap Cap, PTFE/Silicone
5260-11*	11mm Clear Snap Cap, PTFE/Silicone/PTFE
5270-11*	11mm Clear Snap Cap, PTFE/Silicone w/Slit
5271-11*	11mm Clear Snap Cap, PTFE/Silicone w/Y-cut
5275-11*	11mm Clear Snap Cap, PTFE/Silicone w/Cross Slit
5280-11	11mm Clear Snap Cap, PTFE/Silicone/PTFE w/Starburst
5281-11*	11mm Clear Snap Cap, PTFE/Silicone w/Starburst
5282-11	11mm Clear Snap Cap, 10mil PTFE w/Starburst
5290-11	11mm Clear Snap Cap, Viton® Lined

* Available in additional colors; (R) Red, (B) Blue, (G) Green, and (Y) Yellow

Snap Ring™/Crimp Top Vials, 12x32mm, 11mm Crimp Finish

Closures



Snap Top Caps™ with Metal Rings

Finneran 11mm caps are available assembled with a septa and a round metal O-ring for use in any application where instruments must transport the vial to another location using magnets.

Shelf Pack - 100 pieces; Case Pack - 1000 pieces

Cat. No.	Description
5810MR-11*	11mm Clear Snap Cap, PTFE Lined with Metal O-Ring
5840MR-11*	11mm Clear Snap Cap, PTFE/Butyl Rubber Lined w/Metal O-Ring
5850MR-11*	11mm Clear Snap Cap, PTFE/Silicone Lined w/Metal O-Ring
5860MR-11*	11mm Clear Snap Cap, PTFE/Silicone/PTFE Lined w/Metal O-Ring
5870MR-11*	11mm Clear Snap Cap, PTFE/Silicone w/Slit, w/Metal O-Ring

* Available in additional colors; (B) Blue, (BL) Black, (G) Green, (R) Red, & (Y) Yellow



Polypropylene GC Snap Top Caps™

GC Snap Top Caps™ were developed to handle the most volatile samples, providing a liquid airtight seal to the vial. Simply snap on the cap and an evaporation-proof seal of a crimp cap is achieved.

Shelf Pack - 100 pieces; Case Pack - 1000 pieces

Cat. No.	Description
5210-11PP	11mm Polypropylene Snap Cap, 10mil PTFE
5240-11PP	11mm Polypropylene Snap Cap, PTFE/Butyl Rubber
5250-11PP	11mm Polypropylene Snap Cap, PTFE/Silicone
5260-11PP	11mm Polypropylene Snap Cap, PTFE/Silicone/PTFE
5290-11PP	11mm Polypropylene Snap Cap, Black Viton®

Poly Crimp™ Seals (11mm) - Patented

The Finneran patented polypropylene Poly Crimp™ seal fits virtually any 12x32mm sample vial with a crimp style finish. The Poly Crimp™ seal snaps on and off with crimping being an option for a tighter seal. Poly Crimp™ seals are available in a variety of colors for easy sample identification.

Shelf Pack - 100 pieces; Case Pack - 1000 pieces

Cat. No.	Description
5500-11*	11mm Clear Poly Crimp™ Seal, w/Molded Septum
5500SB-11*	11mm Clear Poly Crimp™ Seal, w/Starburst
5510-11*	11mm Clear Poly Crimp™ Seal, w/10mil PTFE
5517-11*	11mm Clear Poly Crimp™ Seal, w/10mil PTFE w/Slit
5540-11*	11mm Clear Poly Crimp™ Seal, PTFE/Butyl Rubber
5550-11*	11mm Clear Poly Crimp™ Seal, PTFE/Silicone
5560-11*	11mm Clear Poly Crimp™ Seal, PTFE/Silicone/PTFE
5570-11*	11mm Clear Poly Crimp™ Seal, PTFE/Silicone w/Slit
5581-11*	11mm Clear Poly Crimp™ Seal, PTFE/Silicone w/Starburst

* Available in additional colors; (B) Blue, (G) Green, (R) Red, & (Y) Yellow



Snap Ring™/Crimp Top Vials, 12x32mm, 11mm Crimp Finish

Closures

Aluminum Seals, Lined

Made of the highest quality aluminum; for use with standard 11mm chromatography vials. The open top allows for filling and retrieving samples with a syringe. Seals are available in a variety of colors for easy sample identification.

Shelf Pack - 100 pieces; Case Pack - 1000 pieces

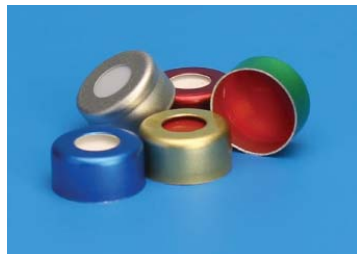

Cat. No.	Description
5110-11*	11mm Silver Seal, 10mil PTFE
5120-11	11mm Silver Seal, 10mil Polypropylene
5140-11*	11mm Silver Seal, Clear PTFE/Red Rubber
5140-11X*	11mm Silver Seal, PTFE/Natural Red Rubber
5141-11	11mm Silver Seal, PTFE/Butyl Rubber
5150-11*	11mm Silver Seal, PTFE/Silicone
5160-11*	11mm Silver Seal, PTFE/Silicone/PTFE
5170-11	11mm Silver Seal, PTFE/Silicone w/Slit
5190-11	11mm Silver Seal, Black Viton®

* Available in additional colors; (B) Blue, (G) Green, (R) Red, & (Y) Gold

11mm Magnetic Seals

Magnetic seals for use with instruments (CTC Analytics PAL) transporting the vials using magnets.

Shelf Pack - 100 pieces; Case Pack - 1000 pieces



5140M-11

Cat. No.	Description
5140M-11	11mm Silver Magnetic Seal, PTFE/Red Rubber
5150M-11	11mm Silver Magnetic Seal, PTFE/Red Silicone
5160M-11	11mm Silver Magnetic Seal, PTFE/Silicone/PTFE

11mm Aluminum Seals – Ultra Low Bleed Septa

Finneran's Ultra Low Bleed Aluminum Seals are lined using a LCMS high purity septa. Ideal for very sensitive applications such as Mass Spec or when multiple injections are required. Our Ultra Low Bleed Seals eliminate particulates with no interfering peaks.

Shelf Pack - 100 pieces; Case Pack - 1000 pieces

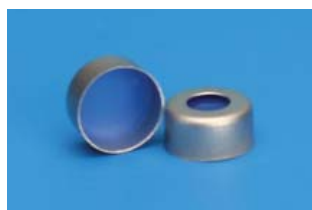

5150UL-11

Cat. No.	Description
5150UL-11*	11mm Silver Seal, 1mm Thick Clear PTFE/Blue Silicone Septa

* Available in additional colors; (B) Blue, (G) Green, (R) Red, & (Y) Gold

Snap Ring™/Crimp Top Vials, 12x32mm, 11mm Crimp Finish

Limited Volume Inserts

All Glass Inserts are available Silanized.



4005BS-625, 401TS-529, 4025-629, 4025BS-629



4025FT-631, 4025BSFT-629



401PTS-530, 4025P-631, 4025P-631BK, 4025PBS-631, 4025PF-631, 425PBS-631BK

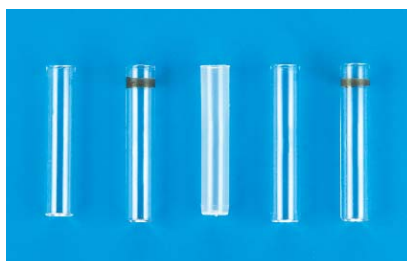

4035-630, 4035-630ID, 4035P-630, 4035-631, 4035-631ID

Conical Glass Insert - Precision-Formed Mandrel Interior

Inserts are available preassembled with a polymer bottom spring or patented Top Spring™. The polymer spring acts as a shock absorber that protects against breakage if the needle bottoms out. The conical design permits complete sample removal. The Step Insert precisely sits in the neck of the vial, thus eliminating the need for metal or plastic springs.

Case Pack - 100 pieces

Cat. No.	Description
4005BS-625	50µL Glass Big Mouth Insert with Bottom Spring
401TS-529	100µL Glass Insert with Patented Top Spring™
4025-629	250µL Glass Big Mouth Insert, No Spring
4025BS-629	250µL Glass Big Mouth Insert with Bottom Spring
4025GF-631	250µL Glass Big Mouth Step Insert with Glass Flange

Conical Glass Inserts - Pulled Point Interior

Shelf Pack - 100 pieces; Case Pack - 1000 pieces

Cat. No.	Description
4025BSFT-629	250µL Glass Big Mouth Insert, with Bottom Spring
4025FT-631	250µL Glass Big Mouth Insert, No Spring

Conical Polypropylene Inserts - Precision-Formed Interior

Shelf Pack - 100 pieces; Case Pack - 1000 pieces

Cat. No.	Description
401PTS-530	100µL Polypropylene Insert with Patented Top Spring™
4025P-631	250µL Polypropylene Big Mouth Insert, No Spring
4025P-631BK	250µL Black Polypropylene Big Mouth Insert, No Spring
4025PBS-631	250µL Polypropylene Big Mouth Insert w/Bottom Spring
425PBS-631BK	250µL Black Polypropylene Big Mouth Insert w/Bottom Spring
4025PF-631	250µL Polypropylene Step Insert with Plastic Flange

Flat Bottom Glass and Polypropylene Inserts

Shelf Pack - 100 pieces; Case Pack - 1000 pieces

Cat. No.	Description
4035-630	350µL Glass Flat Bottom Insert
4035-630ID	350µL Glass Flat Bottom Insert with ID Ring
4035P-630	350µL Polypropylene Flat Bottom Insert
4035-631	350µL Glass Flat Bottom Insert
4035-631ID	350µL Glass Flat Bottom Insert with ID Ring

Snap Ring™/Crimp Top Vials, 12x32mm, 11mm Crimp Finish

Convenience Packs



Convenience Packs

Components packaged in a clear lid tray. Fits into bench drawer for easy access, and packaging keeps products visible and particle free.

Shelf Pack - 100 pieces; Case Pack - 1000 pieces

Cat. No.	Description
920524S-12	Clear Vial, Clear Snap Cap, PTFE/Butyl Rubber
920524S-12A	Amber Vial, Clear Snap Cap, PTFE/Butyl Rubber
920525S-12	Clear Vial, Clear Snap Cap, PTFE/Silicone
920525S-12A	Amber Vial, Clear Snap Cap, PTFE/Silicone

Any combination of vial and closure is available. Please call.

Accessories



Crimpers & Decappers

J.G. Finneran Crimpers and Decappers are designed, and manufactured using quality materials, and finishing techniques to provide a consistent and dependable seal while maintaining their durability, and long life. The standard hand crimpers are provided with an adjustable stop, allowing the operator to repeatedly achieve a quality crimped seal. All parts that contact the crimp seal are stainless steel or plated. The crimper jaws are hardened and polished to provide smooth, consistent operation.

Sold Individually

Cat. No.	Description
9300-11	11mm Hand Operated Crimper
9300-11SS	11mm Hand Operated Crimper, Stainless Steel
9306-11SS	11mm Hand Operated Crimper, Stainless Steel w/Grips
9310-11	11mm Hand Operated Decapper
9320-11	11mm Crimp Type Decapper
9320-11SS	11mm Hand Operated Decapper, Stainless Steel
9326-11SS	11mm Hand Operated Decapper, Stainless Steel w/Grips



Snap Racks™

Snap Racks™ are constructed of durable glass reinforced polypropylene, with a center well to conveniently hold caps, seals, septa, etc. Racks snap together securely to double your rack capacity.

Case Pack - 5 pieces

Cat. No.	Description
9700-12	50 Position White Rack for 12mm Vials
9700-12B	50 Position Blue Rack for 12mm Vials

Multi-Use Universal Vial Rack™ System

Increased spacing allows the user to pipet samples or attach caps without removing the vials from the rack. Frame is made of glass-reinforced polypropylene and insert trays are made of transparent PETG.

Case Pack - 5 pieces

Cat. No.	Description
9600-01	Universal Vial Rack™, Blue Polypropylene, for Insert Trays
9601-12	25 Position Insert Tray for Universal Vial Rack™ for 12mm Vials



Snap Seal™ Vials, Patented, 12x32mm, 11mm Crimp Finish

Finneran Products Certified For Science™

Vials



31811-1232A, 31811-1232,
31811E-1232A, 31811E-1232

The Snap Seal™ Vial can be securely sealed with the patented Poly Crimp™ Seal, an aluminum crimp seal or a variety of Snap Top Cap™ designs. More glass in the neck area minimizes breakage of the neck during decapping. Vial incorporates the unique StepVial design that precisely centers a limited volume insert in the vial neck, assuring dependable, reliable use with autosamplers. Choose from clear or amber Type I borosilicate glass. Available with graduated marking spots which provides the ability to fill a sample vial to a desired level and facilitates viewing sample volumes.

Shelf Pack - 100 pieces; Case Pack - 1000 pieces

Cat. No.	Description
31811-1232	2.0mL Clear Vial
31811-1232A	2.0mL Amber Vial
31811-1232Z	2.0mL Clear Vial, Silanized
31811-1232AZ	2.0mL Amber Vial, Silanized
31811E-1232	2.0mL Clear Vial, White Graduation Spot
31811E-1232A	2.0mL Amber Vial, White Graduation Spot
31811E-1232Z	2.0mL Clear Vial, White Graduation Spot, Silanized
31811E-12AZ	2.0mL Amber Vial, White Graduation Spot, Silanized



3211SS-1232A, 30211SS-1232

Limited Volume Snap Seal™ Vials

The Finneran Interlocked™ Vial is composed of a 12x32 glass vial and a clear glass limited volume insert fused together. This design eliminates movement of the insert, allows more consistent sample recovery, eliminates needle damage and concerns about contaminants around the fused seam/space between the neck of the vial and the insert. Available with marking spots.

Interlocked™ Vials

Case Pack - 100 pieces

Cat. No.	Description
30211SS-1232	300µL Clear Interlocked™ Vial/Insert
3211SS-1232A	300µL Amber Interlocked™ Vial/Insert
3211SSM-1232	300µL Clear Interlocked™ Vial/Insert with Marking Spot
321SSM-1232A	300µL Amber Interlocked™ Vial/Insert with Marking Spot

Also available Silanized



31511P-1232



31511P-12BK

Amber polypropylene adds protection for light sensitive samples. Black polypropylene protects light sensitive samples from having a chemical reaction during sampling, testing, storage, or transport.

Polypropylene Snap Seal™ Vials

Shelf Pack - 100 pieces; Case Pack - 1000 pieces

Cat. No.	Description
31511P-1232	1.5mL Polypropylene Vial
31511P-12A	1.5mL Amber Polypropylene Vial
31511P-12BK	1.5mL Black Polypropylene Vial

Snap Seal™ Vials, Patented, 12x32mm, 11mm Crimp Finish

Closures



Poly Crimp™ Seals - Patented

The Finneran patented polypropylene Poly Crimp™ seal fits virtually any 12x32mm sample vial with a crimp style finish. The Poly Crimp™ seal snaps on and off with crimping being an option for a tighter seal. Poly Crimp™ seals are available in a variety of colors for easy sample identification.

Shelf Pack - 100 pieces; Case Pack - 1000 pieces

Cat. No.	Description
5500-11*	11mm Clear Poly Crimp™ Seal, w/ Molded Septum
5500SB-11*	11mm Clear Poly Crimp™ Seal, w/ Starburst
5510-11*	11mm Clear Poly Crimp™ Seal, 10mil PTFE
5517-11*	11mm Clear Poly Crimp™ Seal, 10mil PTFE w/Slit
5540-11*	11mm Clear Poly Crimp™ Seal, PTFE/Red Rubber
5550-11*	11mm Clear Poly Crimp™ Seal, PTFE/Silicone
5560-11*	11mm Clear Poly Crimp™ Seal, PTFE/Silicone/PTFE
5570-11*	11mm Clear Poly Crimp™ Seal, PTFE/Silicone w/Slit
5581-11*	11mm Clear Poly Crimp™ Seal, PTFE/Sil w/Starburst

* Available in additional colors; (B) Blue, (G) Green, (R) Red, & (Y) Yellow

Snap Top Caps™

Caps may be snapped on and off by hand which eliminates the need for metal crimping and decapping tools, thus reducing potential hazards due to sharp aluminum metal edges. Large opening top provides greater target area for needle penetration. Available in a variety of colors for easy sample identification.

Shelf Pack - 100 pieces; Case Pack - 1000 pieces



Cat. No.	Description
5200-11*	11mm Clear Snap Cap Seal, w/Molded Septum
520070-11	11mm Clear Snap Cap Seal, w/Molded Septum, Pre-Slit
5200SB-11*	11mm Clear Snap Cap Seal, w/Starburst
5210-11*	11mm Clear Snap Cap, 10mil PTFE
5240-11*	11mm Clear Snap Cap, PTFE/Butyl Rubber
5250-11*	11mm Clear Snap Cap, PTFE/Silicone
5260-11*	11mm Clear Snap Cap, PTFE/Silicone/PTFE
5270-11*	11mm Clear Snap Cap, PTFE/Silicone w/Slit
5271-11*	11mm Clear Snap Cap, PTFE/Silicone w/Y-cut
5275-11*	11mm Clear Snap Cap, PTFE/Silicone w/Cross Slit
5280-11*	11mm Clear Snap Cap, PTFE/Silicone/PTFE w/Starburst
5281-11*	11mm Clear Snap Cap, PTFE/Silicone w/Starburst
5282-11*	11mm Clear Snap Cap, 10mil PTFE w/Starburst
5290-11*	11mm Clear Snap Cap, Viton® Lined

* Available in additional colors; (B) Blue, (BL) Black, (G) Green, (O) Orange, (PK) Pink, (R) Red, (Y) Yellow

Snap Top Caps™ with Metal Rings

Finneran 11mm seals are available assembled with a septa and a round metal O-ring for use in any application where instruments must transport the vial to another location using magnets.

Shelf Pack - 100 pieces; Case Pack - 1000 pieces



Cat. No.	Description
5810MR-11*	11mm Clear Snap Cap, PTFE Lined with Metal O-Ring
5840MR-11*	11mm Clear Snap Cap, PTFE/Butyl Rubber Lined w/Metal O-Ring
5850MR-11*	11mm Clear Snap Cap, PTFE/Silicone Lined w/Metal O-Ring
5860MR-11*	11mm Clear Snap Cap, PTFE/Silicone/PTFE Lined w/Metal O-Ring
5870MR-11*	11mm Clear Snap Cap, PTFE/Silicone w/Slit Lined w/Metal O-Ring

* Available in additional colors; (B) Blue, (BL) Black, (G) Green, (R) Red, & (Y) Yellow

Snap Seal™ Vials, Patented, 12x32mm, 11mm Crimp Finish

Closures



Polypropylene GC Snap Top Caps™

GC Snap Top Caps™ were developed to handle the most volatile samples, providing a liquid airtight seal to the vial. Simply snap on the cap and an evaporation-proof seal of a crimp cap is achieved.

Shelf Pack - 100 pieces; Case Pack - 1000 pieces

Cat. No.	Description
5210-11PP	11mm Polypropylene Snap Cap, 10mil PTFE
5240-11PP	11mm Polypropylene Snap Cap, PTFE/Butyl Rubber
5250-11PP	11mm Polypropylene Snap Cap, PTFE/Silicone
5260-11PP	11mm Polypropylene Snap Cap, PTFE/Silicone/PTFE
5290-11PP	11mm Polypropylene Snap Cap, Black Viton®



Aluminum Seals, Lined

Made of the highest quality aluminum; for use with standard 11mm chromatography vials. The open top allows for filling and retrieving samples with a syringe. Seals are available in a variety of colors for easy sample identification.

Shelf Pack - 100 pieces; Case Pack - 1000 pieces

Cat. No.	Description
5110-11*	11mm Silver Seal, 10mil PTFE
5120-11	11mm Silver Seal, 10mil Polypropylene
5140-11*	11mm Silver Seal, Clear PTFE/Red Rubber
5140-11X*	11mm Silver Seal, Clear PTFE/Natural Red Rubber
5141-11	11mm Silver Seal, Clear PTFE/Butyl Rubber
5150-11*	11mm Silver Seal, PTFE/Silicone
5160-11*	11mm Silver Seal, PTFE/Silicone/PTFE
5170-11	11mm Silver Seal, PTFE/Silicone w/Slit
5190-11	11mm Silver Seal, Black Viton®

* Available in bulk packaging & additional colors; (B) Blue, (G) Green, (R) Red, & (Y) Gold



11mm Magnetic Seals

Magnetic seals for use with instruments (CTC Analytics PAL) transporting the vials using magnets.

Shelf Pack - 100 pieces; Case Pack - 1000 pieces

Cat. No.	Description
5140M-11	11mm Silver Magnetic Seal, PTFE/Red Rubber
5150M-11	11mm Silver Magnetic Seal, PTFE/Red Silicone
5160M-11	11mm Silver Magnetic Seal, PTFE/Silicone/PTFE

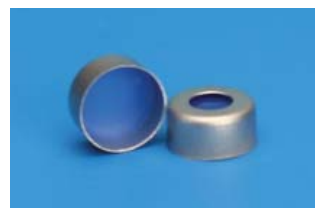

5150UL-11

11mm Aluminum Seals – Ultra Low Bleed Septa

Finneran's Ultra Low Bleed Aluminum Seals are lined using a LCMS high purity septa. Ideal for very sensitive applications such as Mass Spec or when multiple injections are required. Our Ultra Low Bleed Seals eliminate particulates with no interfering peaks.

Shelf Pack - 100 pieces; Case Pack - 1000 pieces

Cat. No.	Description
5150UL-11*	11mm Silver Seal, 1mm Thick Clear PTFE/Blue Silicone Septa

* Available in additional colors; (B) Blue, (G) Green, (R) Red, & (Y) Gold

Snap Seal™ Vials, Patented, 12x32mm, 1mm Crimp Finish

Limited Volume Inserts

All Glass Inserts are available Silanized.



4005BS-625, 401TS-529, 4025-629, 4025BS-629



4025FT-631, 4025BSFT-629



401PTS-530, 4025P-631, 4025P-631BK, 4025PBS-631, 4025PF-631, 425PBS-631BK

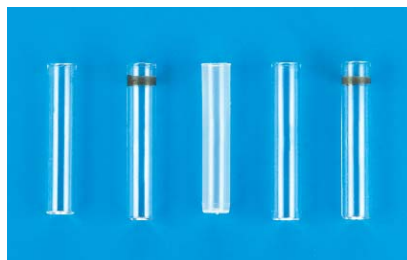

4035-630, 4035-630ID, 4035P-630, 4035-631, 4035-631ID

Conical Glass Inserts - Precision-Formed Mandrel Interior

Inserts are available preassembled with a polymer bottom spring or patented Top Spring™. The polymer spring acts as a shock absorber that protects against breakage if the needle bottoms out. The conical design permits complete sample removal. The Step Insert precisely sits in the neck of the vial, thus eliminating the need for metal or plastic springs.

Case Pack - 100 pieces

Cat. No.	Description
4005BS-625	50µL Glass Big Mouth Insert with Bottom Spring
401TS-529	100µL Glass Insert with Patented Top Spring™
4025-629	250µL Glass Big Mouth Insert, No Spring
4025BS-629	250µL Glass Big Mouth Insert with Bottom Spring
4025GF-631	250µL Glass Big Mouth Step Insert with Glass Flange

Conical Glass Inserts - Pulled Point Interior

Shelf Pack - 100 pieces; Case Pack - 1000 pieces

Cat. No.	Description
4025BSFT-629	250µL Glass Big Mouth Insert, with Bottom Spring
4025FT-631	250µL Glass Big Mouth Insert, No Spring

Conical Polypropylene Inserts - Precision-Formed Interior

Shelf Pack - 100 pieces; Case Pack - 1000 pieces

Cat. No.	Description
401PTS-530	100µL Polypropylene Insert with Patented Top Spring™
4025P-631	250µL Polypropylene Big Mouth Insert, No Spring
4025P-631BK	250µL Black Polypropylene Big Mouth Insert, No Spring
4025PBS-631	250µL Polypropylene Big Mouth Insert w/Bottom Spring
425PBS-631BK	250µL Black Polypropylene Big Mouth Insert w/Bottom Spring
4025PF-631	250µL Polypropylene Step Insert with Plastic Flange

Flat Bottom Glass and Polypropylene Inserts

Shelf Pack - 100 pieces; Case Pack - 1000 pieces

Cat. No.	Description
4035-630	350µL Glass Flat Bottom Insert
4035-630ID	350µL Glass Flat Bottom Insert with ID Ring
4035P-630	350µL Polypropylene Flat Bottom Insert
4035-631	350µL Glass Flat Bottom Insert
4035-631ID	350µL Glass Flat Bottom Insert with ID Ring

Snap Seal™ Vials, Patented, 12x32mm, 11mm Crimp Finish

Convenience Packs



Convenience Packs

Components packaged in a clear lid tray. Fits into bench drawer for easy access, and packaging keeps products visible and particle free.

Shelf Pack - 100 pieces; Case Pack - 1000 pieces

Cat. No.	Description
918525-12	Clear Vial, Clear Snap Cap, PTFE/Silicone
918526-12	Clear Vial, Clear Snap Cap, PTFE/Silicone/PTFE
918554-12	Clear Vial, Clear PolyCrimp™ Seal, PTFE/Rubber
918555-12	Clear Vial, Clear PolyCrimp™ Seal, PTFE/Silicone
918556-12	Clear Vial, Clear PolyCrimp™ Seal, PTFE/Silicone/PTFE

Any combination of vial and closure is available. Please call.

Accessories



Crimpers/Decappers for 11mm Crimp Vials

J.G. Finneran Crimpers and Decappers are designed, and manufactured using quality materials, and finishing techniques to provide a consistent and dependable seal while maintaining their durability, and long life. The standard hand crimpers are provided with an adjustable stop, allowing the operator to repeatedly achieve a quality crimped seal. All parts that contact the crimp seal are stainless steel or plated. The crimper jaws are hardened and polished to provide smooth, consistent operation.

Sold Individually

Cat. No.	Description
9300-11	11mm Hand Operated Crimper
9300-11SS	11mm Hand Operated Crimper, Stainless Steel
9306-11SS	11mm Hand Operated Crimper, Stainless Steel w/Grips
9310-11	11mm Hand Operated Decapper (Plier Style)
9320-11	11mm Crimp Type Decapper
9320-11SS	11mm Hand Operated Decapper, Stainless Steel
9326-11SS	11mm Hand Operated Decapper, Stainless Steel w/Grips



Snap Racks™

Snap Racks™ are constructed of durable glass reinforced polypropylene, with a center well to conveniently hold caps, seals, septa, etc. Racks snap together securely to double your rack capacity.

Case Pack - 5 pieces

Cat. No.	Description
9700-12	50 Position White Rack for 12mm Vials
9700-12B	50 Position Blue Rack for 12mm Vials



Multi-Use Universal Vial Rack™ System

Increased spacing allows the user to pipet samples or attach caps without removing the vials from the rack. Frame is made of glass-reinforced polypropylene and insert trays are made of transparent PETG.

Case Pack - 5 pieces

Cat. No.	Description
9600-01	Universal Vial Rack™, Blue Polypropylene, for Insert Trays
9601-12	25 Position Insert Tray for Universal Vial Rack™ for 12mm Vials

Standard Opening Screw Thread Vials, 12x32mm, 8-425mm Neck Finish

Finneran Products Certified For Science™

Vials



32008-1232A, 32008-1232,
32008E-1232A, 32008E-1232



32008-1230A, 32008-1230



31108-1232



30208-1232



30208M-1232A



30108G-1232A, 30108G-1232

Narrow opening allows use of 8-425mm closures and septa. Designed to work in a variety of autosampler requiring narrow neck vials. Choose from clear or amber Type I borosilicate glass. Available with graduated marking spots.

Shelf Pack - 100 pieces; Case Pack - 1000 pieces

Cat. No.	Description
32008-1232	2.0mL Clear Vial
32008-1232A	2.0mL Amber Vial
32008-1232Z	2.0mL Clear Vial, Silanized
32008-1232AZ	2.0mL Amber Vial, Silanized
32008E-1232	2.0mL Clear Vial, White Graduation Spot
32008E-1232A	2.0mL Amber Vial, White Graduation Spot

Perkin-Elmer Standard Opening Screw Thread Vials

Designed to work in Perkin Elmer equipment.

Shelf Pack - 100 pieces; Case Pack - 1000 pieces

Cat. No.	Description
32008-1230	2.0mL Clear Vial
32008-1230A	2.0mL Amber Vial

Tapered Bottom Vials

Manufactured from Type I borosilicate clear glass, the tapered bottom allows for the concentration of samples into the tip by solvent evaporation.

Shelf Pack - 100 pieces; Case Pack - 1000 pieces

Cat. No.	Description
31108-1232	1.1mL Clear Tapered Bottom Vial, 12x32mm

Limited Volume Standard Opening Screw Thread Vials

The Finneran Interlocked™ Vial is composed of a 12x32 glass vial and a clear glass limited volume insert fused together. This design eliminates movement of the insert, allows more consistent sample recovery, eliminates needle damage and concerns about contaminants around the fused seam/space between the neck of the vial and the insert. Available with marking spots.

Interlocked™ Screw Thread Vials

Case Pack - 100 pieces

Cat. No.	Description
30208-1232	100µL Clear Interlocked™ Vial/Insert
30208-1232A	100µL Amber Interlocked™ Vial/Insert
30208M-1232	100µL Clear Interlocked™ Vial/Insert with Marking Spot
30208M-1232A	100µL Amber Interlocked™ Vial/Insert with Marking Spot

Interlocked™ Vials are also available Silanized

J. G. Finneran is the original designer and manufacturer of the Glass Insert/Plastic Vial (Glastic). The Finneran Glastic Vial is a unique combination of Type I low extractable borosilicate glass insert and clear or amber thermoplastic polymer outer vial shell. The glass is the only contact between the sample and the seal.

Glastic - Glass Insert/Plastic Outside Screw Thread Vials

Case Pack - 100 pieces

Cat. No.	Description
30108G-1232	100µL Glass/Clear Plastic LVV
30108G-1232A	100µL Glass/Amber Plastic LVV

Standard Opening Screw Thread Vials, 12x32mm, 8-425mm Neck Finish

Vials



Designed to work in most standard autosamplers. Finneran polypropylene vials are light-weight, economical and have good chemical resistance. These limited volume vials provides maximum retrieval of contents.

Polypropylene and TPX Screw Thread Vials

Shelf Pack - 100 pieces; Case Pack - 1000 pieces

Cat. No.	Description
30108P-1232	100µL Polypropylene Vial
30108CP-1232	100µL Clear Polypropylene Vial
30108T-1232	100µL TPX (Polymethylpentene) Vial
31508P-1232	1.5mL Polypropylene Vial

Closures



Screw Thread Closures (8-425mm)

Available in a wide assortment of colors. Designed for use with all autosamplers. The Top Seal™ closure with a 10mil molded septa allows for easy needle penetration and is inert to most solvents. The one piece design saves time by eliminating the process of assembling liners in the closures.

Shelf Pack - 100 pieces; Case Pack - 1000 pieces

Cat. No.	Description
5310-08*	Black, Polypropylene Large Open Hole Cap for Shimadzu
5310L-08	Black, Polypropylene Large Open Hole Cap, Flangeless
5310L-08W	White, Polypropylene Large Open Hole Cap, Flangeless
5320-08	Black Polypropylene Unlined, Solid Top
5320-08W	White Polypropylene Unlined, Solid Top
5330-08	Top Seal™ Closure, Clear Polypropylene, molded 10mil septa
5330-08W	Top Seal™ Closure, White Polypropylene, molded 10mil septa
5330PE-08	Top Seal™ Closure, Clear Polyethylene, molded 10mil septa
5330SB-08	Top Seal™ Closure, Clear Polypropylene, 10mil Starburst septa
5360-08**	Solid Top, Black Polypropylene, PTFE/F217 Lined
5360PH-08G	Solid Top, Green Thermoset, PTFE/F217 Lined
5380-08	Black Solid Top Closure, Pulp/Foil Lined

* Available in bulk packaging and additional colors; (B) Blue, (G) Green, (O) Orange, (R) Red, (W) White & (Y) Yellow
 ** Available in additional colors; (R) Red, (G) Green, and (W) White, and (Y) Yellow



5330-08



5360-08

Septa for Screw Thread Closures (8-425mm)

Shelf Pack - 100 pieces; Case Pack - 1000 pieces

Cat. No.	Description
601010-08	8mm x 0.010" White PTFE Septa
601080-08	8mm x 0.010" White PTFE Septa w/Slit
603090-08	8mm x 0.030" Black Viton® Septa
603570-08	8mm x 0.035" Red PTFE/White Silicone w/Slit Septa
604040-08	8mm x 0.045" PTFE/Red Rubber Septa
604040-08F	8mm x 0.045" PTFE/Butyl Rubber Septa
604060-08	8mm x 0.040" Red PTFE/Silicone/Red PTFE Septa
604550-08	8mm x 0.045" Red PTFE/White Silicone Septa
605050-08	8mm x 0.050" Red PTFE/White Silicone Septa
606070-08	8mm x 0.060" Red PTFE/White Silicone w/Slit Septa
606550-08	8mm x 0.065" Red PTFE/White Silicone Septa
606550B-08	8mm x 0.065" Blue PTFE/White Silicone Septa
606550T-08	8mm x 0.065" Tan PTFE/White Silicone Septa
607550-08	8mm x 0.075" Red PTFE/White Silicone Septa



Standard Opening Screw Thread Vials, 12x32mm, 8-425mm Neck Finish

Closures

Preassembled Screw Thread Open Hole Closure and Septa (8-425mm)

Choose the preassembled caps with septa best suited for your application. The patented Top Hat™ septa and closure was designed to provide a positive physical lock to assure that preassembled components arrive intact.



806550TH-08Y

Case Pack - 100 pieces

Cat. No.	Description
803570-08	Black Closure, PTFE/Silicone Septa, 0.035" with Slit
804040-08	Black Closure, PTFE/Red Rubber Septa, 0.040"
804040L-08	Black Flangeless Closure, PTFE/Red Rubber Septa, 0.040"
804060-08	Black Closure, PTFE/Silicone/PTFE Septa, 0.040"
804060L-08	Black Flangeless Closure, PTFE/Silicone/PTFE Septa, 0.040"
804061-08	Black Closure, Bonded Red PTFE/Silicone Septa, 0.040"
804071-08	Black Closure, Bonded Red PTFE/Silicone Septa, 0.040" with Slit
805050-08	Black Closure, Red PTFE/Silicone Septa, 0.050"
805050-08W	White Closure, Red PTFE/Silicone Septa, 0.050"
805050L-08	Black Flangeless Closure, Red PTFE/Silicone Septa, 0.050"
806070-08	Black Closure, Red PTFE/Silicone Septa, 0.060" with Slit
806070L-08	Black Flangeless Closure, Red PTFE/Sil Septa, 0.060" with Slit
806550-08	Black Closure, Red PTFE/Silicone Septa, 0.065"
806550L-08	Black Flangeless Closure, Red PTFE/Silicone Septa, 0.065"
806550TH-08	Black Top Hat™ PTFE/Silicone Septa/Closure (Patented)
806550TH-08B	Blue Top Hat™ PTFE/Silicone Septa/Closure (Patented)
806550TH-08Y	Yellow Top Hat™ PTFE/Silicone Septa/Closure (Patented)

Limited Volume Inserts

All Glass Inserts are available Silanized.

Conical Glass Inserts - Precision-Formed Mandrel Interior

Inserts are available preassembled with a polymer bottom spring or patented Top Spring™. The polymer spring acts as a shock absorber that protects against breakage if the needle bottoms out. The conical design permits complete sample removal.

Case Pack - 100 pieces

Cat. No.	Description
4005BS-425	50µL Glass Insert with Bottom Spring
401F-529	100µL Glass Insert with Plastic Flange
401TF-529	100µL Glass Insert with Flange
401-530	100µL Glass Insert, No Spring
401BS-530	100µL Glass Insert with Bottom Spring
401-531	200µL Glass Insert, No Spring
4015BS-529	150µL Glass Insert with Bottom Spring



401-530, 401-531, 4015BS-529

Conical Glass Inserts - Pulled Point Interior

Shelf Pack - 100 pieces; Case Pack - 1000 pieces

Cat. No.	Description
402FT-531	200µL Glass Conical Limited Volume Insert, No Spring



402FT-531

Standard Opening Screw Thread Vials, 12x32mm, 8-425mm Neck Finish

Limited Volume Inserts



401CP-530, 401P-530, 401PBS-530



4025P-531, 4025-531, 4025-531ID

Conical Polypropylene Inserts - Precision-Formed Interior

Shelf Pack - 100 pieces; Case Pack - 1000 pieces

Cat. No.	Description
401CP-530	100µL Clear Polypropylene Insert, No Spring
401P-530	100µL Polypropylene Insert, No Spring
401PBS-530	100µL Polypropylene Insert with Bottom Spring

Flat Bottom Glass and Polypropylene Inserts

Shelf Pack - 100 pieces; Case Pack - 1000 pieces

Cat. No.	Description
4025-531	250µL Glass Flat Bottom Insert
4025-531ID	250µL Glass Flat Bottom Insert with ID Ring
4025P-531	250µL Polypropylene Flat Bottom Insert

Preassembled Convenience Packs

Preassembled Convenience Packs

Components packaged in a clear tray that fits into bench drawer for easy access. Packaging keeps products visible and particle free. Preassembled packs come ready to use. Closures and septa of your choice are attached to the vials.

Case Pack - 100 pieces

Cat. No.	Description
801010-1232	Clear Vial, Closure, PTFE Septa, 0.010"
801010-1232A	Amber Vial, Closure, PTFE Septa, 0.010"
803570-1232	Clear Vial, Closure, PTFE/Silicone Septa, 0.035" w/Slit
804040-1232	Clear Vial, Closure, PTFE/Red Rubber Septa, 0.040"
804040-1232A	Amber Vial, Closure, PTFE/Red Rubber Septa, 0.040"
804060-1232	Clear Vial, Closure, Red PTFE/SIL/Red PTFE, 0.040"
804060-1232A	Amber Vial, Closure, Red PTFE/SIL/Red PTFE, 0.040"
804550-1232	Clear Vial, Closure, PTFE/Silicone Septa, 0.045"
804550-1232A	Amber Vial, Closure, Red PTFE/Silicone Septa, 0.045"
804550L-1232	Clear Vial, Flangeless Closure, PTFE/Silicone Septa, 0.045"
806070-1232	Clear Vial, Closure, Red PTFE/Silicone Septa, 0.065", w/Slit
806070-1232A	Amber Vial, Closure, Red PTFE/Silicone Septa, 0.065", w/Slit
806550-1232	Clear Vial, Closure, Red PTFE/Silicone Septa, 0.065"
806550-1232A	Amber Vial, Closure, Red PTFE/Silicone Septa, 0.065"
806550E-12A	Amber Vial w/Grad. Spot, White Cap, Red PTFE/SIL Septa, 0.045"

Any combination of vial, closure and septa is available. Please call.



Standard Opening Screw Thread Vials, 12x32mm, 8-425mm Neck Finish

Convenience Packs



Convenience Packs

Components packaged in a clear lid tray with 100 vials and 100 preassembled closures and septa that fits into bench drawer for easy access. Packaging keeps products visible and particle free. Convenience Packs come ready to use.

Shelf Pack - 100 pieces; Case Pack - 1000 pieces

Cat. No.	Description
90865-12	Clear Vial, Closure, Red PTFE/SIL, 0.065"
90865-12A	Amber Vial, Closure, Red PTFE/SIL, 0.065"

Available in many Vial/Closure combinations. Please call us with your specific requirements.

Accessories



Snap Racks™

Snap Racks™ are constructed of durable glass reinforced polypropylene, with a center well to conveniently hold caps, seals, septa, etc. Racks snap together securely to double your rack capacity.

Case Pack - 5 pieces

Cat. No.	Description
9700-12	50 Position White Rack for 12mm Vials
9700-12B	50 Position Blue Rack for 12mm Vials



Multi-Use Universal Vial Rack™ System

Increased spacing allows the user to pipet samples or attach caps without removing the vials from the rack. Frame is made of glass-reinforced polypropylene and insert trays are made of transparent PETG.

Case Pack - 5 pieces

Cat. No.	Description
9600-01	Universal Vial Rack™, Blue Polypropylene, for Insert Trays
9601-12	25 Position Insert Tray for Universal Vial Rack™ for 12mm Vials

R.A.M.™ Large Opening Vials, 12x32mm, 9mm Neck Finish

Finneran Products Certified For Science™

Vials



32009-1232A, 32009-1232, 32009E-1232A, 32009E-1232



32009TR-1232



32009RB-1232, 3209RB-1232A



30209-1232, 30209-1232A, 30209M-1232, 30209M-1232A

Finneran R.A.M.™ Vials designed specifically to work in robotic arm autosamplers have a crimp style height with the convenience of a screw thread configuration. Choose from clear or amber Type I borosilicate glass. Vials are available with or without graduated marking spots. Vials are also available silanized.

Shelf Pack - 100 pieces; Case Pack - 1000 pieces

Cat. No.	Description
32009-1232	2.0mL Clear Vial
32009-1232A	2.0mL Amber Vial
32009-1232Z	2.0mL Clear Vial, Silanized
32009-1232AZ	2.0mL Amber Vial, Silanized
32009E-1232	2.0mL Clear Vial, White Graduation Spot
32009E-1232A	2.0mL Amber Vial, White Graduation Spot

The 9mm Transfer Ring Vial for use in robotic arm autosamplers. The transfer ring allows a robotic arm to pick up the vial without having a closure attached. When the transfer ring vial is used with a closure the ring prevents over-torquing (over-tightening) while providing a tight seal and eliminating any evaporation concerns.

Cat. No.	Description
32009TR-1232	2.0mL Clear Vial with Transfer Ring
32009TRE-12	2.0mL Clear Vial with Transfer Ring, Graduated Marking Spot

Round Bottom Large Opening R.A.M.™ Vials

Shelf Pack - 100 pieces; Case Pack - 1000 pieces

Cat. No.	Description
32009RB-1232	2.0mL Clear Round Bottom Vial
3209RB-1232A	2.0mL Amber Round Bottom Vial

Limited Volume Large Opening R.A.M.™ Vials

The Finneran Interlocked™ Vial is composed of a 12x32 glass vial and a clear glass limited volume insert fused together. This design eliminates movement of the insert, allows more consistent sample recovery, eliminates needle damage and concerns about contaminants around the fused seam/space between the neck of the vial and the insert. Available with marking spots.

Interlocked™ Vials

Case Pack - 100 pieces

Cat. No.	Description
30209-1232	300µL Clear Interlocked™ R.A.M. Vial/Insert
30209-1232A	300µL Amber Interlocked™ R.A.M. Vial/Insert
30209FB-1232	350µL Clear Interlocked™ R.A.M. Vial/Flat Bottom Insert
30209M-1232	300µL Clear Interlocked™ R.A.M. Vial/Insert with Marking Spot
30209M-1232A	300µL Amber Interlocked™ R.A.M. Vial/Insert with Marking Spot
30209MFB-12	350µL Clear Interlocked™ R.A.M. Vial/Flat Bottom Insert w/Marking Spot

Also available Silanized

R.A.M.™ Large Opening Vials, 12x32mm, 9mm Neck Finish

Vials



30109G-1232A, 30109G-1232



30209FB-1232, 30209FB-1232A



80209-1232, 80209-1232A, 80209M-1232



30109P*-1232, 30109CP-1232, 30109T-1232



31509P-1232

31709P-1232

J.G. Finneran is the original designer and manufacturer of the Glass Insert/Plastic Outside Vial (Glastic). Glastic is a unique combination of Type I low extractable borosilicate glass insert and clear or amber thermoplastic polymer outer vial shell. The glass is the only contact between the sample and the seal.

Glastic - Glass Insert/Plastic Outside Vials

Case Pack - 100 pieces

Cat. No.	Description
30109G-1232	100µL R.A.M.™ Glass Insert/Clear Plastic Vial
30109G-1232A	100µL R.A.M.™ Glass Insert/Amber Plastic Vial

Pre-Assembled R.A.M.™ Vials with Flanged Flat Bottom Step Insert

Shelf Pack- 100 pieces; Case Pack - 1000 pieces

Cat. No.	Description
80209FB-1232	Clear Glass R.A.M.™ Vial, 350µL capacity
8029FB-1232A	Amber Glass R.A.M.™ Vial, 350µL capacity
8029FBE-1232	Clear Glass R.A.M.™ Vial with Graduated Spot, 350µL capacity
829FBE-1232A	Amber Glass R.A.M.™ Vial with Graduated Spot, 350µL capacity
8029FBM-1232	Clear Glass R.A.M.™ Vial with Marking Spot, 350µL capacity
829FBM-1232A	Amber Glass R.A.M.™ Vial with Marking Spot, 350µL capacity

Also available Silanized

Pre-Assembled R.A.M.™ Vials with Step Insert

Case Pack - 100 pieces

Cat. No.	Description
80209-1232	250µL Clear Glass R.A.M.™ Vial with Step Insert
80209-1232A	250µL Amber Glass R.A.M.™ Vial with Step Insert
80209M-1232	250µL Clear Glass R.A.M.™ Vial with Step Insert and Marking Spot
80209M-1232A	250µL Amber Glass R.A.M.™ Vial with Step Insert and Marking Spot

Also available Silanized

Polypropylene and TPX Vials

Polypropylene vials are an economical alternative to glass. Finneran polypropylene vials are manufactured from chemical resistant polypropylene. TPX vials provide the clarity of glass and safety of polypropylene, and can withstand maximum temperature up to 175°C. Amber polypropylene adds protection for light sensitive samples. Black polypropylene protects light sensitive samples from having a chemical reaction during sampling, testing, storage, or transport.

Shelf Pack - 100 pieces; Case Pack - 1000 pieces

Cat. No.	Description
30109P-1232	100µL to 300µL Polypropylene R.A.M.™ Vial
30109P-1232A	100µL to 300µL Amber Polypropylene R.A.M.™ Vial
30109P-12BK	100µL to 300µL Black Polypropylene R.A.M.™ Vial
30109CP-1232	100µL to 300µL Clear Polypropylene R.A.M.™ Vial
30109T-1232	100µL to 300µL TPX (Polymethylpentene) R.A.M.™ Vial
30509P-1232	500µL Polypropylene R.A.M.™ Vial
30509P-1232A	500µL Amber Polypropylene R.A.M.™ Vial
30509P-12BK	500µL Black Polypropylene R.A.M.™ Vial
30509CP-1232	500µL Clear Polypropylene R.A.M.™ Vial
30709P-1232	700µL Polypropylene R.A.M.™ Vial
31509P-1232	1.5mL Polypropylene R.A.M.™ Vial
31509P-12A	1.5mL Amber Polypropylene R.A.M.™ Vial
31509P-12BK	1.5mL Black Polypropylene R.A.M.™ Vial
31709P-1232	1.7mL Polypropylene R.A.M.™ Vial

R.A.M.™ Large Opening Vials, 12x32mm, 9mm Neck Finish

Vials



31509-1232

Solid Glass High Recovery Vials

One piece conical design allowing complete sample recovery.

Case Pack - 100 pieces

Cat. No.	Description
31509-1232	1.5mL Clear R.A.M.™ High Recovery Glass Vial
31509-1232A	1.5mL Amber R.A.M.™ High Recovery Glass Vial

Also available Silanized

Septa & Closures



5321-09



5330-09



5360-09

Screw Thread Closures - 9mm

Shelf Pack - 100 pieces; Case Pack - 1000 pieces

Cat. No.	Description
5310-09F*	9mm R.A.M.™ Ribbed Closure, Polypropylene, Open Hole
5310F-09*	9mm R.A.M.™ Smooth Closure, Polypropylene, Open Hole
5320-09*	9mm R.A.M.™ Ribbed Solid Top Closure, Black Polypropylene, Unlined
5321-09	9mm R.A.M.™ Ribbed Solid Top Closure, Black Polypropylene, PTFE Lined
5330-09	9mm R.A.M.™ Ribbed Top Seal™ Closure, Clear PP, molded 10mil septa
53550-09F	9mm R.A.M.™ Ribbed Solid Top Closure, Black PP, PTFE/Silicone Lined
53550-09FRB	9mm R.A.M.™ Ribbed Solid Top Closure, Royal Blue PP, PTFE/Silicone Lined
5360-09*	9mm R.A.M.™ Ribbed Solid Top Closure, Black PP, PTFE/F217 Lined

* Available in bulk packaging and additional colors; (G) Green, (N) Natural, (O) Orange, (PK) Pink, (R) Red, (RB) Royal Blue, and (Y) Yellow

Septa for R.A.M.™ Screw Thread Closures

Shelf Pack - 100 pieces; Case Pack - 1000 pieces

Cat. No.	Description
601010-09	9mm x 0.010" White PTFE Septa
604040-09	9mm x 0.040" PTFE/Red Rubber Septa
604040-09F	9mm x 0.040" PTFE/Butyl Rubber Septa
604050-09	9mm x 0.040" PTFE/Silicone Septa
604060-09	9mm x 0.040" Red PTFE/Silicone/Red PTFE Septa
604070-09	9mm x 0.040" Red PTFE/Silicone w/Slit Septa



Preassembled R.A.M.™ Smooth Screw Thread Closure and Septa

Preassembled closures and septa come ready to use. Designed to work in Agilent or other robotic-arm autosamplers.

Shelf Pack - 100 pieces; Case Pack - 1000 pieces

Cat. No.	Description
5371F-09RB	9mm R.A.M.™ Royal Blue Closure, PTFE/Silicone Lined w/Y-Cut
5391F-09*	9mm R.A.M.™ Black Closure, PTFE Lined
53917F-09RB	9mm R.A.M.™ Royal Blue Closure, PTFE Lined with Slit
5394F-09*	9mm R.A.M.™ Black Closure, PTFE/Butyl Rubber
5395F-09*	9mm R.A.M.™ Black Closure, PTFE/Silicone
5395XF-09RB	9mm R.A.M.™ Royal Blue Closure, PTFE/Silicone w/Cross-Slit
5396F-09*	9mm R.A.M.™ Black Closure, PTFE/Silicone/PTFE
5397F-09*	9mm R.A.M.™ Black Closure, PTFE/Silicone w/Slit
5399F-09*	9mm R.A.M.™ Black Closure, Black Viton® Lined

* Available in additional colors; (G) Green, (N) Natural, (O) Orange, (PK) Pink, (R) Red, (RB) Royal Blue, and (Y) Yellow



R.A.M.™ Large Opening Vials, 12x32mm, 9mm Neck Finish

Septa & Closures



Preassembled R.A.M.™ Smooth Screw Thread Closure and Bonded Septa

Shelf Pack - 100 pieces; Case Pack - 1000 pieces

Cat. No.	Description
53951F-09*	9mm R.A.M.™ Black Closure, Bonded PTFE/Silicone Septa
53971F-09*	9mm R.A.M.™ Black Closure, Bonded PTFE/Silicone Septa w/Slit

* Available in additional colors; (G) Green, (N) Natural, (O) Orange, (PK) Pink, (R) Red, (RB) Royal Blue, and (Y) Yellow

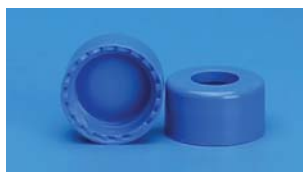

Preassembled R.A.M.™ Smooth Screw Thread Closure and Ultra Low Bleed Septa for Mass Spec (9mm)

Finneran's Ultra Low Bleed Aluminum Seals are lined using a LCMS high purity septa. Ideal for very sensitive applications such as Mass Spec or when multiple injections are required. Our Ultra Low Bleed Seals eliminate particulates with no interfering peaks.

Shelf Pack - 100 pieces; Case Pack - 1000 pieces

Cat. No.	Description
5395ULF-09RB	9mm R.A.M.™ Closure, Royal Blue, Clear PTFE/Blue Silicone
5395U1F-09RB	9mm R.A.M.™ Closure, Royal Blue, Bonded Clear PTFE/Blue Silicone
5397ULF-09RB	9mm R.A.M.™ Closure, Royal Blue, Clear PTFE/Blue Silicone w/Slit
5397U1F-09RB	9mm R.A.M.™ Closure, Royal Blue, Bonded, Clear PTFE/Blue Silicone w/Slit



Preassembled R.A.M.™ Ribbed Screw Thread Closure and Septa

Shelf Pack - 100 pieces; Case Pack - 1000 pieces

Cat. No.	Description
5391-09F*	9mm R.A.M.™ Black Closure, PTFE Lined
53917-09FRB	9mm R.A.M.™ Royal Blue Closure, PTFE Lined with Slit
5394-09F*	9mm R.A.M.™ Black Closure, PTFE/Butyl Rubber
5395-09F*	9mm R.A.M.™ Black Closure, PTFE/Silicone
5395-09FW	9mm R.A.M.™ White Closure, PTFE/Silicone
5395X-09FRB	9mm R.A.M.™ Royal Blue Closure, PTFE/Silicone w/Cross-Slit
5396-09F*	9mm R.A.M.™ Black Closure, PTFE/Silicone/PTFE
5397-09F*	9mm R.A.M.™ Black Closure, PTFE/Silicone w/Slit

5399-09F* 9mm R.A.M.™ Black Closure, Black Viton® Lined
 * Available in additional colors; (G) Green, (N) Natural, (O) Orange, (PK) Pink, (R) Red, (RB) Royal Blue, & (Y) Yellow



Preassembled R.A.M.™ Ribbed Screw Thread Closure and Bonded Septa

Shelf Pack - 100 pieces; Case Pack - 1000 pieces

Cat. No.	Description
53951-09F*	9mm R.A.M.™ Black Closure, Bonded PTFE/Silicone Septa
53951-09FW	9mm R.A.M.™ White Closure, Bonded PTFE/Silicone Septa
53971-09F*	9mm R.A.M.™ Black Closure, Bonded PTFE/Silicone Septa w/Slit

* Available in additional colors; (G) Green, (N) Natural, (O) Orange, (PK) Pink, (R) Red, (RB) Royal Blue, and (Y) Yellow

R.A.M.™ Large Opening Vials, 12x32mm, 9mm Neck Finish



Preassembled R.A.M.™ Ribbed Screw Thread Closure and Ultra Low Bleed Septa for Mass Spec (9mm)

Finneran's Ultra Low Bleed Aluminum Seals are lined using a LCMS high purity septa. Ideal for very sensitive applications such as Mass Spec or when multiple injections are required. Our Ultra Low Bleed Seals eliminate particulates with no interfering peaks.

Shelf Pack - 100 pieces; Case Pack - 1000 pieces

Cat. No.	Description
5395UL-09FRB	9mm R.A.M.™ Royal Blue Closure, Clear PTFE/Blue Silicone
5395U1-09FRB	9mm R.A.M.™ Royal Blue Closure, Bonded Clear PTFE/Blue Silicone
5397UL-09FRB	9mm R.A.M.™ Royal Blue Closure, Clear PTFE/Blue Silicone w/Slit
5397U1-09FRB	9mm R.A.M.™ Royal Blue Closure, Bonded, Clear PTFE/Blue Silicone w/Slit



Preassembled R.A.M.™ Magnetic Cover, Screw Thread Closure & Septa

Magnetic seals for use with instruments (CTC, Analytics, PAL) transporting the vials using magnets.

Case Pack - 100 pieces

Cat. No.	Description
5394M-09FN	9mm R.A.M.™ Magnetic Closure, PTFE/Butyl Rubber
5395M-09FN	9mm R.A.M.™ Magnetic Closure, PTFE/Silicone
5396M-09FN	9mm R.A.M.™ Magnetic Closure, PTFE/Silicone/PTFE
5397M-09FN	9mm R.A.M.™ Magnetic Closure, PTFE/Silicone w/Slit

Limited Volume Inserts

All Glass Inserts are available Silanized.



4005BS-625, 401TF-529, 401TS-529, 4025-629, 4025BS-629



4025FT-631, 4025BSFT-629

Conical Glass Inserts - Precision-Formed Mandrel Interior

Inserts are available preassembled with a polymer bottom spring or patented Top Spring™. The polymer spring acts as a shock absorber that protects against breakage if the needle bottoms out. The conical design permits complete sample removal. The Step Insert precisely sits in the neck of the vial, eliminating the need for metal or plastic springs.

Case Pack - 100 pieces

Cat. No.	Description
4005BS-625	50µL Glass Big Mouth Insert with Bottom Spring
401TF-529	100µL Glass Insert with Flange
401TS-529	100µL Glass Insert with Patented Top Spring™
4025-629	250µL Glass Big Mouth Insert, No Spring
4025BS-629	250µL Glass Big Mouth Insert with Bottom Spring

Conical Glass Inserts - Pulled Point Interior

Shelf Pack - 100 pieces; Case Pack - 1000 pieces

Cat. No.	Description
4025BSFT-629	250µL Glass Big Mouth Insert, with Bottom Spring
4025FT-631	250µL Glass Big Mouth Insert, No Spring



401PTS-530, 4025P-631, 4025P-631BK, 4025PBS-631, 4025PF-631, 425PBS-631BK

Conical Polypropylene Inserts - Precision-Formed Interior

Shelf Pack - 100 pieces; Case Pack - 1000 pieces

Cat. No.	Description
401PTS-530	100µL Polypropylene Insert with Patented Top Spring™
4025P-631	250µL Polypropylene Big Mouth Insert, No Spring
4025P-631BK	250µL Black Polypropylene Big Mouth Insert, No Spring
4025PBS-631	250µL Polypropylene Big Mouth Insert w/Bottom Spring
425PBS-631BK	250µL Black Polypropylene Big Mouth Insert w/Bottom Spring

J.G. Finneran Associates, Inc. — Visit www.JGFinneran.com • 1-800-552-3696 • 1-856-696-3605

Engineered and manufactured in compliance with ISO 9001:2015 certified guidelines

R.A.M.™ Large Opening Vials, 12x32mm, 9mm Neck Finish

Limited Volume Inserts

All Glass Inserts are available Silanized.

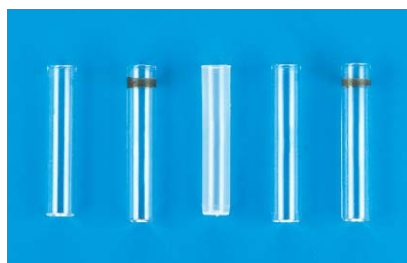

4035-630, 4035-630ID, 4035P-630,
4035-631, 4035-631ID

Flat Bottom Glass and Polypropylene Inserts

Shelf Pack - 100 pieces; Case Pack - 1000 pieces

Cat. No.	Description
4035-630	350µL Glass Flat Bottom Insert
4035-630ID	350µL Glass Flat Bottom Insert with ID Ring
4035P-630	350µL Polypropylene Flat Bottom Insert
4035-631	350µL Glass Flat Bottom Insert
4035-631ID	350µL Glass Flat Bottom Insert with ID Ring

Convenience Packs



Preassembled R.A.M.™ Vials & Screw Thread/Septa Closure Kits

Case Pack - 100 pieces

Cat. No.	Description
80494-12AFRB	Amber R.A.M.™ Vial, 0.040" PTFE/Butyl Rubber Septa, Ribbed Royal Blue Cap
80494EF-12RB	Clear R.A.M.™ Vial w/Graduated Spot, 0.040" PTFE/Butyl Rubber Septa, Smooth Royal Blue Cap
80495F-12	Clear R.A.M.™ Vial, PTFE/Silicone Septa, Smooth Black Cap
80496EF-12RB	Clear R.A.M.™ Vial w/Graduated Spot, PTFE/Silicone/PTFE Septa, Smooth Royal Blue Cap

* Available in many vial/closure combinations, Please contact us with your specific requirements.

Convenience Packs

Shelf Pack - 100 pieces; Case Pack - 1000 pieces

Cat. No.	Description
909535F-12	Clear R.A.M.™ Vial, Smooth Black Cap, PTFE/Silicone
909535F-12G	Clear R.A.M.™ Vial, Smooth Green Cap, PTFE/Silicone
909535F-12N	Clear R.A.M.™ Vial, Smooth Natural Cap, PTFE/Silicone
909535F-12R	Clear R.A.M.™ Vial, Smooth Red Cap, PTFE/Silicone
909535F-12RB	Clear R.A.M.™ Vial, Smooth Royal Blue Cap, PTFE/Silicone
909535F-12Y	Clear R.A.M.™ Vial, Smooth Yellow Cap, PTFE/Silicone
909535EF-12	Clear R.A.M.™ Vial w/Graduated Spot, Smooth Black Cap, PTFE/Silicone
909535EF-12G	Clear R.A.M.™ Vial w/Graduated Spot, Smooth Green Cap, PTFE/Silicone
909535EF-12N	Clear R.A.M.™ Vial w/Graduated Spot, Smooth Natural Cap, PTFE/Silicone
99535EF-12RB	Clear R.A.M.™ Vial w/Graduated Spot, Smooth Royal Blue Cap, PTFE/Silicone
99535F-12ARB	Amber R.A.M.™ Vial, Smooth Royal Blue Cap, PTFE/Silicone
909535EF-12A	Amber R.A.M.™ Vial w/Graduated Spot, Smooth Black Cap, PTFE/Silicone
99535EF-12AG	Amber R.A.M.™ Vial w/Graduated Spot, Smooth Green Cap, PTFE/Silicone
99535EF-12AN	Amber R.A.M.™ Vial w/Graduated Spot, Smooth Natural Cap, PTFE/Silicone
99535EF-12AR	Amber R.A.M.™ Vial w/Graduated Spot, Smooth Red Cap, PTFE/Silicone
9535EF-12ARB	Amber R.A.M.™ Vial w/Graduated Spot, Smooth Royal Blue Cap, PTFE/Silicone
99535EF-12AY	Amber R.A.M.™ Vial w/Graduated Spot, Smooth Yellow Cap, PTFE/Silicone
909536F-12	Clear R.A.M.™ Vial, Smooth Black Cap, PTFE/Silicone/PTFE
909537F-12	Clear R.A.M.™ Vial, Smooth Black Cap, PTFE/Silicone w/Slit
909537EF-12	Clear R.A.M.™ Vial w/Graduated Spot, Smooth Black Cap, PTFE/Silicone w/Slit
909537F-12A	Amber R.A.M.™ Vial, Smooth Black Cap, PTFE/Silicone w/Slit
909537EF-12A	Amber R.A.M.™ Vial w/Graduated Spot, Smooth Black Cap, PTFE/Silicone w/Slit

* Available in many vial/closure combinations, Please contact us with your specific requirements.



R.A.M.™ Large Opening Vials, 12x32mm, 9mm Neck Finish

J.G. Finneran the industry leader in quality chromatography vials and accessories now offers Certified Vial Kits for LC and Mass Spec. Understanding the importance of using particulate free vials for sample preparation, our vials are tested to meet the high standards our customers require. LC Certified and Mass Spec Vials are available with or without graduated marking spots. Choose from bonded PTFE/Silicone or bonded PTFE/Silicone with slit septa. Our sealed and re-closeable container includes:

- (100) Certified 2.0mL screw thread vials
- (100) 9mm royal blue closures with bonded septa
- Certificate of Conformance



Certified Vial Kits (with Certificate of Conformance)

LC Certified Vial Test Parameters include:

- Glass – Type I, Class A, 33 Expansion Clear or 51A Amber Borosilicate
- Dimensions – Height, Diameter, Bottom Thickness, Neck Length, Thread Profile, Annealing
- Cap/Septum – Diameter, Height, Thread Integrity, Center Flash, Septa Insertion
- Chemical Test – HPLC Test – Non-volatile residue, GC Test – Volatile Residue

Certified Vial Kits: Certified 2.0mL, 12x32mm R.A.M.™ Vial with 9mm R.A.M.™ Royal Blue Polypropylene Open Top Cap

Case Pack - 100 pieces

Cat. No.	Description
CERT95-12	Certified Clear Glass Vial, PP Open Top Cap, Royal Blue, Bonded PTFE/Silicone
CERT95-12A	Certified Amber Glass Vial, PP Open Top Cap, Royal Blue, Bonded PTFE/Silicone
CERT95E-12	Certified Clear Glass Vial w/Grad Spot, PP Open Top Cap, Royal Blue, Bonded PTFE/Silicone
CERT95E-12A	Certified Amber Glass Vial w/Grad Spot, PP Open Top Cap, Royal Blue, Bonded PTFE/Silicone
CERT97-12	Certified Clear Glass Vial, PP Open Top Cap, Royal Blue, Bonded PTFE/Silicone w/Slit
CERT97-12A	Certified Amber Glass Vial, PP OT Cap, Royal Blue, Bonded PTFE/Silicone w/Slit
CERT97E-12	Certified Clear Glass Vial w/Grad Spot, PP Open Top Cap, Royal Blue, Bonded PTFE/Silicone w/Slit
CERT97E-12A	Certified Amber Glass Vial w/Grad Spot, PP Open Top Cap, Royal Blue, Bonded PTFE/Silicone w/Slit

Mass Spec Certified Vial Kits (with Certificate of Conformance)

Mass Spec Vial Test Parameters include:

- Glass – Type 1, Class A, 33 Expansion Clear or 51A Amber Borosilicate
- Dimensions – Height, Diameter, Bottom Thickness, Neck Length, Thread Profile, Annealing
- Cap/Septum – Diameter, Height, Thread Integrity, Center Flash, Septa Insertion
- GC/MS Background Test
- LC/MS Background Test
- Particle Counts – Particle Size, Particle/mL/Vial

Mass Spec Certified Vial Kits: Mass Spec Certified 2.0mL, 12x32mm R.A.M.™ Vial with 9mm R.A.M.™ Royal Blue Polypropylene Open Top Cap

Case Pack - 100 pieces

Cat. No.	Description
MSC95-12	Mass Spec Certified Clear Glass Vial, PP Open Top Cap, Royal Blue, Bonded PTFE/Silicone
MSC95-12A	Mass Spec Certified Amber Glass Vial, PP Open Top Cap, Royal Blue, Bonded PTFE/Silicone
MSC95E-12	Mass Spec Certified Clear Glass Vial w/Grad. Spot, PP Open Top Cap, Royal Blue, Bonded PTFE/Silicone
MSC95E-12A	Mass Spec Certified Amber Glass Vial w/Grad Spot, PP Open Top Cap, Royal Blue, Bonded PTFE/Silicone
MSC97-12	Mass Spec Certified Clear Glass Vial, PP Open Top Cap, Royal Blue, Bonded PTFE/Silicone w/Slit
MSC97-12A	Mass Spec Certified Amber Glass Vial, PP Open Top Cap, Royal Blue, Bonded PTFE/Silicone w/Slit
MSC97E-12	Mass Spec Certified Clear Glass Vial w/Grad Spot, PP Open Top Cap, Royal Blue, Bonded PTFE/Silicone w/Slit
MSC97E-12A	Mass Spec Certified Amber Glass Vial w/Grad Spot, PP Open Top Cap, Royal Blue, Bonded PTFE/Silicone w/Slit



Big Mouth Screw Thread Vials, 12x32mm, 10-425mm Neck Finish

Finneran Products Certified For Science™

Vials



32010-1232, 32010-1232A,
32010E-1232A, 32010E-1232

40% larger opening prevents broken needles due to increased target area. Choose from clear or amber Type I borosilicate glass. ID design incorporates the StepVial feature that precisely centers a limited volume insert in the vial neck. Available with graduated marking spots.

Shelf Pack - 100 pieces; Case Pack - 1000 pieces

Cat. No.	Description
32010-1232	2.0mL Clear Vial
32010-1232A	2.0mL Amber Vial
32010-1232Z	2.0mL Clear Vial, Silanized
32010-1232AZ	2.0mL Amber Vial, Silanized
32010E-1232	2.0mL Clear Vial, White Graduation Spot
32010E-1232A	2.0mL Amber Vial, White Graduation Spot



30210-1232, 30210-1232A,
30210M-1232, 30210M-1232A

Limited Volume Big Mouth Screw Thread Vials

The Finneran Interlocked™ Vial is composed of a 12x32 glass vial and a clear glass limited volume insert fused together. This design eliminates movement of the insert, allows more consistent sample recovery, eliminates needle damage and concerns about contaminants around the fused seam/space between the neck of the vial and the insert. Available with marking spots.

Interlocked™ Screw Thread Vials

Case Pack - 100 pieces

Cat. No.	Description
30210-1232	300µL Clear Interlocked™ Vial/Insert
30210-1232A	300µL Amber Interlocked™ Vial/Insert
30210M-1232	300µL Clear Interlocked™ Vial/Insert with Marking Spot
30210M-1232A	300µL Amber Interlocked™ Vial/Insert with Marking Spot

Also available Silanized



30510P-1232, 30510CP-1232, 30510T-1232

Limited Volume Polypropylene & TPX Big Mouth Screw Thread Vials

Amber polypropylene adds protection for light sensitive samples. Black polypropylene protects light sensitive samples from having a chemical reaction during sampling, testing, storage, or transport.

Shelf Pack- 100 pieces; Case Pack - 1000 pieces

Cat. No.	Description
30510P-1232	500µL Polypropylene Vial
30510P-1232A	500µL Amber Polypropylene Vial
30510P-12BK	500µL Black Polypropylene Vial
30510CP-1232	500µL Clear Polypropylene Vial
30510T-1232	500µL TPX (Polymethylpentene) Vial
30710P-1232	750µL Polypropylene Vial
30710P-1232A	750µL Amber Polypropylene Vial
30710P-12BK	750µL Black Polypropylene Vial
30710CP-1232	750µL Clear Polypropylene Vial
30710T-1232	750µL TPX (Polymethylpentene) Vial



30710P-1232, 30710CP-1232, 30710T-1232

Big Mouth Screw Thread Vials, 12x32mm, 10-425mm Neck Finish

Closures



Screw Thread Closures

Larger opening provides increased target area for needle penetration. Closures are ideal for autosamplers requiring closures to support or hang in vial tray (Hitachi, Jasco, Shimadzu). Available in a wide assortment of colors. The Top Seal™ closure with a 10mil molded septa allows for easy needle penetration and is inert to most solvents. The one piece design saves time by eliminating the process of assembling liners in the closures.

Shelf Pack - 100 pieces; Case Pack - 1000 pieces

Cat. No.	Description
5310-10*	Black, Polypropylene Open Hole Cap
5320-10*	Black Polypropylene Unlined Cap, Solid Top
5330-10	Top Seal™ Closure, Clear Polypropylene, molded 10mil septa
5330SB-10	Top Seal™ Closure, Clear Polypropylene, molded Starburst 10mil septa
5360-10*	Solid Top, Black Polypropylene PTFE/F217 Lined Cap

* Available in bulk packaging and additional colors; (B) Blue, (G) Green, (R) Red, (W) White, and (Y) Yellow

Septa for Screw Thread Closures

Shelf Pack - 100 pieces; Case Pack - 1000 pieces

Cat. No.	Description
601010-10	10mm x 0.010" White PTFE Septa
603090-10	10mm x 0.030" Black Viton® Septa
604040-10	10mm x 0.040" PTFE/Red Rubber Septa
604040-10F	10mm x 0.040" PTFE/Butyl Rubber Septa
604060-10	10mm x 0.040" Red PTFE/White Silicone/Red PTFE Septa
604070-10	10mm x 0.040" Red PTFE/White Silicone w/Slit Septa
605050-10	10mm x 0.050" Red PTFE/White Silicone Septa
606050-10	10mm x 0.060" Red PTFE/White Silicone Septa
606070-10	10mm x 0.060" Red PTFE/White Silicone w/Slit Septa
606090-10	10mm x 0.060" Black Viton® Septa
607550-10	10mm x 0.075" Red PTFE/White Silicone Septa



Preassembled Screw Thread Closure and Septa

Case Pack - 100 pieces

Cat. No.	Description
804040-10	Black Closure, PTFE/Red Rubber Septa, 0.040"
804060-10	Black Closure, PTFE/Silicone/PTFE Septa, 0.040"
804070-10	Black Closure, PTFE/Silicone/PTFE Septa, 0.040" w/Slit
805050-10	Black Closure, Red PTFE/Silicone Septa, 0.050"
806050-10	Black Closure, Red PTFE/Silicone Septa, 0.060"
806070-10	Black Closure, Red PTFE/Silicone Septa, 0.060" w/Slit
806090-10	Black Closure, Black Viton® Septa, 0.060"

* Available in additional colors; (B) Blue, (G) Green, (R) Red, (W) White, and (Y) Yellow



Big Mouth Screw Thread Vials, 12x32mm, 10-425mm Neck Finish

Limited Volume Inserts

All Glass Inserts are available Silanized.



4005BS-625, 401TS-529, 4025-629, 4025BS-629



4025FT-631, 4025BSFT-629



401PTS-530, 4025P-631, 4025P-631BK, 4025PBS-631, 4025PF-631, 425PBS-631BK

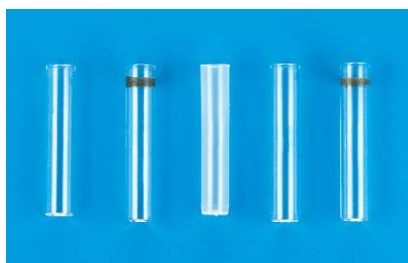

4035-630, 4035-630ID, 4035P-630, 4035-631, 4035-631ID



Conical Glass Inserts - Precision-Formed Mandrel Interior

Inserts are available preassembled with a polymer bottom spring or patented Top Spring™. The polymer spring acts as a shock absorber that protects against breakage if the needle bottoms out. The conical design permits complete sample removal. The Step Insert precisely sits in the neck of the vial, thus eliminating the need for metal or plastic springs.

Case Pack - 100 pieces

Cat. No.	Description
4005BS-625	50µL Glass Big Mouth Insert with Bottom Spring
401TS-529	100µL Glass Insert with Patented Top Spring™
4025-629	250µL Glass Big Mouth Insert, No Spring
4025BS-629	250µL Glass Big Mouth Insert with Bottom Spring
4025GF-631	250µL Glass Big Mouth Step Insert with Glass Flange

Conical Glass Inserts - Pulled Point Interior

Shelf Pack - 100 pieces; Case Pack - 1000 pieces

Cat. No.	Description
4025BSFT-629	250µL Glass Big Mouth Insert, with Bottom Spring
4025FT-631	250µL Glass Big Mouth Insert, No Spring

Conical Polypropylene Inserts - Precision-Formed Interior

Shelf Pack - 100 pieces; Case Pack - 1000 pieces

Cat. No.	Description
401PTS-530	100µL Polypropylene Insert with Patented Top Spring™
4025P-631	250µL Polypropylene Big Mouth Insert, No Spring
4025P-631BK	250µL Black Polypropylene Big Mouth Insert, No Spring
4025PBS-631	250µL Polypropylene Big Mouth Insert w/Bottom Spring
425PBS-631BK	250µL Black Polypropylene Big Mouth Insert w/Bottom Spring
4025PF-631	250µL Polypropylene Step Insert with Plastic Flange

Flat Bottom Glass and Polypropylene Inserts

Shelf Pack - 100 pieces; Case Pack - 1000 pieces

Cat. No.	Description
4035-630	350µL Glass Flat Bottom Insert
4035-630ID	350µL Glass Flat Bottom Insert with ID Ring
4035P-630	350µL Polypropylene Flat Bottom Insert
4035-631	350µL Glass Flat Bottom Insert
4035-631ID	350µL Glass Flat Bottom Insert with ID Ring

Pre-Assembled Vials with Step Insert

Big Mouth Screw Thread Vials Assembled with Flanged Insert

Case Pack - 100 pieces

Cat. No.	Description
80210-1232	Clear Step 10-425mm Threaded Vial, 12x32mm, w/250µL Glass Insert
80210-1232A	Amber Step 10-425mm Threaded Vial, 12x32mm, w/250µL Glass Insert

Big Mouth Screw Thread Vials, 12x32mm, 10-425mm Neck Finish

Convenience Packs

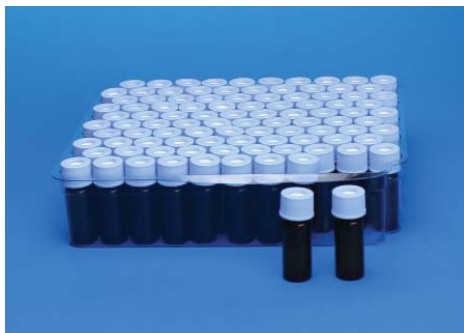

Preassembled Convenience Packs

Components packaged in a clear tray that fits into bench drawer for easy access. Packaging keeps products visible and particle free. Preassembled packs come ready to use. Closures and septa of your choice are attached to the vials.

Case Pack - 100 pieces

Cat. No.	Description
801010T-1232	Clear Threaded Vial, Black Closure, PTFE Septa, 0.010"
80101T-1232A	Amber Threaded Vial, Black Closure, PTFE Septa, 0.010"
804040T-1232	Clear Threaded Vial, Closure, PTFE/Red Rubber Septa, 0.040"
80404T-1232A	Amber Threaded Vial, Closure, PTFE/Red Rubber Septa, 0.040"
804060T-1232	Clear Threaded Vial, Black Closure, Red PTFE/Silicone/Red PTFE, 0.040"
804060T-12B	Clear Threaded Vial, Blue Closure, Red PTFE/Silicone/Red PTFE, 0.040"
80406T-1232A	Amber Threaded Vial, Closure, Red PTFE/Silicone/Red PTFE, 0.040"
805050T-12W	Clear Threaded Vial, White Closure, Red PTFE/Silicone Septa, 0.050"
806070T-1232	Clear Threaded Vial, Closure, Red PTFE/Silicone Septa, 0.065", w/Slit
806070T-12A	Amber Threaded Vial, Closure, Red PTFE/Silicone Septa, 0.065", w/Slit
806550T-1232	Clear Threaded Vial, Closure, Red PTFE/Silicone Septa, 0.065"
80655T-1232A	Amber Threaded Vial, Closure, Red PTFE/Silicone Septa, 0.065"

Any combination of vial, closure and septa is available. Please call.



Convenience Packs

Components packaged in a clear lid tray with 100 vials and 100 preassembled closures and septa that fits into bench drawer for easy access. Packaging keeps products visible and particle free. Convenience Packs come ready to use.

Shelf Pack - 100 Pieces, Case Pack - 1000 pieces

Cat. No.	Description
9104040-12	Clear Vial, Black Closure, PTFE/Red Rubber Septa, 0.040"
9104060-12	Clear Vial, Black Closure, PTFE/Silicone/PTFE, 0.040"
9106050-12	Clear Vial, Black Closure, Red PTFE/Silicone, 0.065"

Any combination of vial, closure and septa is available. Please call.

Accessories



Snap Racks™

Snap Racks™ are constructed of durable glass reinforced polypropylene, with a center well to conveniently hold caps, seals, septa, etc. Racks snap together securely to double your rack capacity.

Case Pack - 5 pieces

Cat. No.	Description
9700-12	50 Position White Rack for 12mm Vials
9700-12B	50 Position Blue Rack for 12mm Vials



Multi-Use Universal Vial Rack™ System

Increased spacing allows the user to pipet samples or attach caps without removing the vials from the rack. Frame is made of glass-reinforced polypropylene and insert trays are made of transparent PETG.

Case Pack - 5 pieces

Cat. No.	Description
9600-01	Universal Vial Rack™, Blue Polypropylene, for Insert Trays
9601-12	25 Position Insert Tray for Universal Vial Rack™ for 12mm Vials

12x32mm Shell Vials, 12mm Plug

Finneran Products Certified For Science™

Vials



Glass Shell Vials

Available in clear or amber Type I borosilicate glass, or polypropylene for easy disposal. Vials feature thicker walls for safer sample handling. Limited volume shell vials have a precisely designed conical bottom which permits maximum sample evacuation.

Shelf Pack - 100 pieces; Case Pack - 1000 pieces

Cat. No.	Description
4100-1232	2.0mL Clear Glass Shell Vial
4100-1232A	2.0mL Amber Glass Shell Vial
4100M-1232	2.0mL Clear Glass Shell Vial with Marking Spot
4100M-1232A	2.0mL Amber Glass Shell Vial with Marking Spot
4100-1235	2.0mL Clear Glass Shell Vial, 12x35mm Also available Silanized

Polypropylene Shell Vials

Shelf Pack - 100 pieces; Case Pack - 1000 pieces

Cat. No.	Description
4100P-1232	2.0mL Polypropylene Shell Vial
4100P-1232D	2.0mL Polypropylene Shell Vial for Dionex
4115P-1232	1.5mL Polypropylene Shell Vial

Round Bottom Vials

Shelf Pack - 100 pieces; Case Pack - 1000 pieces

Cat. No.	Description
4100RB-1232	2.0mL Clear Round Bottom Shell Vial

Closures



12mm PE Flat Top Plug



12mm PE Conical Snap Plug with Starburst

Polyethylene Flat Top Snap Plug (12mm)

Shelf Pack - 100 pieces; Case Pack - 1000 pieces

Cat. No.	Description
5400FT-12	12mm Clear Polyethylene Flat Top Snap Plug

Polyethylene Conical Snap Plugs with Starburst (12mm)

Starburst and conical design of the snap plug provides self-centering needle penetration guidance as well as better resealability of plug after use. Plug is designed to easily push in and remove from the vial. Tight fit offers good sealability.

Shelf Pack - 100 pieces; Case Pack - 1000 pieces

Cat. No.	Description
5405SB-12*	12mm Clear Polyethylene Snap Plug
5410SB-12	12mm Clear Polyethylene Snap Plug, Pre-scored Starburst

* Available in additional colors; (B) Blue, (G) Green, (R) Red, & (Y) Yellow

Shell Vials, 12x32mm, 12mm Plug



Multi-Plugs with Safety Sleeve

The Multi-Plug Safety Sleeve is available in clear K-resin or black glass reinforced polypropylene. Use it as a tool to make plug and shell vial assembly easier and safer. The safety sleeve is “Multi” useful because it is designed to work with 1mL, 2mL or 4mL shell vials. One Safety Sleeve works with all three sizes.

Case Pack - 5 pieces

Cat. No.	Description
9200-81215	Multi-Plug Safety Sleeve Clear
9200-81215B	Multi-Plug Safety Sleeve Black

Limited Volume Inserts

All Glass Inserts are available Silanized.



4025BS-629, 4025PBS-631, 4025BSFT-629

Due to the conical design of the snap plug, limited volume inserts used in the shell vial stay centered and straight allowing for easy sample evacuation.

Conical Glass Inserts - Precision-Formed Mandrel Interior

Case Pack - 100 pieces

Cat. No.	Description
4025BS-629	250µL Glass Big Mouth Insert with Bottom Spring

Conical Glass Inserts - Pulled Point Interior

Shelf Pack - 100 pieces; Case Pack - 1000 pieces

Cat. No.	Description
4025BSFT-629	250µL Glass Big Mouth Insert, with Bottom Spring

Conical Polypropylene Inserts - Precision-Formed Interior

Shelf Pack - 100 pieces; Case Pack - 1000 pieces

Cat. No.	Description
4025PBS-631	250µL Polypropylene Big Mouth Insert w/Bottom Spring

Convenience Packs



Convenience Packs with 12x32mm Shell Vials and 12mm Conical Snap Plugs

Components packaged in a clear tray with 100 shell vials and 100 conical snap plugs. Snap Plugs are not attached to the vials and are in individual plastic bags. Fits into bench drawer for easy access and packaging keeps products visible and particle-free.

Shelf Pack - 100 pieces; Case Pack - 1000 pieces

Cat. No.	Description
9800-1232	2.0mL Clear Shell Vial & Plug Convenience Pack
9800-1232A	2.0mL Amber Shell Vial & Plug Convenience Pack
9800P-1232	2.0mL Polypropylene Shell Vial & Plug Convenience Pack
9815P-1232	1.5mL Polypropylene Shell Vial & Plug Convenience Pack

Any combination of vial and closure is available. Please call.

Accessories



Snap Racks™

Snap Racks™ are constructed of durable glass reinforced polypropylene, with a center well to conveniently hold caps, seals, septa, etc. Racks snap together securely to double your rack capacity.

Case Pack - 5 pieces

Cat. No.	Description
9700-12	50 Position White Rack for 12mm Vials
9700-12B	50 Position Blue Rack for 12mm Vials

Versa Vials™, 12x32mm, 9mm Opening

Finneran Products Certified For Science™

Vials



32012-1232, 32012-1232A,
32012M-1232, 32012M-1232M,
5004-12, 5005-12, 5003-12G

The Versa Vial™ is a 12x32mm shell vial with a modified neck that allows pick-up by an autosampler. This vial can be used in most autosamplers that currently use 12x32mm vials. The vase-like design of the Versa Vial™ system has the largest opening available for any autosampler. The elongated pick-up area, in the neck, accommodates variations in the robotic arm settings for reliable sample pick-up. The wide ID, 9mm opening, allows samples to be added using a pipet tip. Choose from clear or amber Type I borosilicate glass. Marking spots are available.

Shelf Pack - 100 pieces; Case Pack - 1000 pieces

Cat. No.	Description
32012-1232	2.0mL Clear Vial
32012-1232A	2.0mL Amber Vial
32012M-1232	2.0mL Clear Vial, White Marking Spot
32012M-1232A	2.0mL Amber Vial, White Marking Spot



Polypropylene Vials

The polypropylene Versa Vial™ has a larger sample volume capacity than other 12x32mm polypropylene autosampler vials, an advantage for ion chromatography applications.

Shelf Pack - 100 pieces; Case Pack - 1000 pieces

Cat. No.	Description
31512P-1232	1.5mL Polypropylene Vial

Closures



5004-12, 5003-12G, 5005-12

Versa Vial™ Plugs (12mm)

The softer VersaVial™ plugs eliminates cracked necks and the resulting sharp edges encountered when using standard shell vial plugs.

Shelf Pack - 100 pieces; Case Pack - 1000 pieces

Cat. No.	Description
5003-12G	12mm Polyethylene Plug - Green
5004-12	12mm Chlorobutyl/Siliconized Plug
5005-12	12mm White PTFE/Silicone Plug
5070-12	12mm PTFE/Silicone with Slit Plug

Versa Vials™, 12x32mm, 9mm Opening

Limited Volume Inserts

All Glass Inserts are available Silanized.

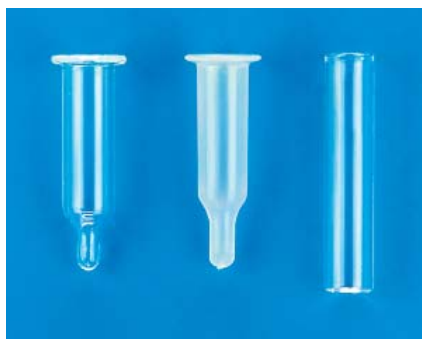

4025GF-625, 4025P-625, 4025-628

Conical Glass Inserts - Precision-Formed Mandrel Interior

The conical design of the inserts permits complete sample removal.

Case Pack - 100 pieces

Cat. No.	Description
4025GF-625	250µL Glass Insert with Glass Flange

Conical Polypropylene Inserts - Precision-Formed Interior

The conical design of the inserts permits complete sample removal.

Shelf Pack - 100 pieces; Case Pack - 1000 pieces

Cat. No.	Description
4025P-625	250µL Polypropylene Insert with Polypropylene Flange

Glass Flat Bottom Inserts

Shelf Pack - 100 pieces; Case Pack - 1000 pieces

Cat. No.	Description
4025-628	250µL Glass Flat Bottom Insert

Accessories



Snap Racks™

Snap Racks™ are constructed of durable glass reinforced polypropylene, with a center well to conveniently hold caps, seals, septa, etc. Racks snap together securely to double your rack capacity.

Case Pack - 5 pieces

Cat. No.	Description
9700-12	50 Position White Rack for 12mm Vials
9700-12B	50 Position Blue Rack for 12mm Vials



Multi-Use Universal Vial Rack™ System

Increased spacing allows the user to pipet samples or attach caps without removing the vials from the rack. Frame is made of glass-reinforced polypropylene and insert trays are made of transparent PETG.

Case Pack - 5 pieces

Cat. No.	Description
9600-01	Universal Vial Rack™, Blue Polypropylene, for Insert Trays
9601-12	25 Position Insert Tray for Universal Vial Rack™ for 12mm Vials

Snap Ring™ Vials, 15x45mm, 13mm Crimp Finish

Finneran Products Certified For Science™

Vials



34013S-1545, 34013S-1545A



30313G-1545



32513PS-1545

Neck finish allows use of Snap Top Caps™ or standard aluminum seals. Designed to work in Shimadzu and Waters WISP™ 48 position autosamplers. Choose from clear or amber Type I borosilicate glass. ID design incorporates the StepVial feature that precisely centers a limited volume insert in the vial neck. Available with graduated marking spots.

Shelf Pack - 100 pieces; Case Pack - 1000 pieces

Cat. No.	Description
34013S-1545	4.0mL Clear Vial
34013S-1545A	4.0mL Amber Vial
34013SE-1545*	4.0mL Clear Vial, White Graduation Spot
34013SE-15A*	4.0mL Amber Vial, White Graduation Spot
34013S-1545Z	4.0mL Clear Vial, Silanized
34013S-15AZ	4.0mL Amber Vial, Silanized

Limited Volume Snap Ring™ Vials

J.G. Finneran is the original designer and manufacturer of the Glass Insert/Plastic Outside Vial (Glastic). Glastic is a unique combination of Type I low extractable borosilicate glass insert and a clear or amber thermoplastic polymer outer vial shell. The glass is the only contact between the sample and the seal.

Glass Insert/Plastic Outside Vials

Case Pack - 100 pieces

Cat. No.	Description
30313G-1545	300µL Glass/Clear Plastic LVV (100 per pack)

Polypropylene Snap Ring™ Vials

Shelf Pack - 100 pieces; Case Pack - 1000 pieces

Cat. No.	Description
32513PS-1545	2.5mL Polypropylene LVV

Closures



Snap Top Caps™ (13mm)

Caps may be snapped on and off by hand which eliminates the need for metal crimping and decapping tools, reducing potential hazards due to sharp aluminum metal edges. Large opening top provides greater target area for needle penetration.

Shelf Pack - 100 pieces; Case Pack - 1000 pieces

Cat. No.	Description
5200SB-13	13mm Clear Snap Cap Seal w/Starburst
5210-13	13mm Clear Snap Cap, 10mil PTFE
5240-13	13mm Clear Snap Cap, PTFE/Butyl Rubber
5250-13	13mm Clear Snap Cap, PTFE/Silicone
5260-13	13mm Clear Snap Cap, PTFE/Silicone/PTFE
5270-13	13mm Clear Snap Cap, PTFE/Silicone w/Slit
5280-13	13mm Snap Cap, PTFE/Silicone/PTFE w/Starburst
5281-13	13mm Clear Snap Cap, PTFE/Silicone w/Starburst

Snap Ring™ Vials, 15x45mm, 13mm Crimp Finish

Closures

Aluminum Seals, Lined

Made of the highest quality aluminum; for use with standard 11mm chromatography vials. The open top allows for filling and retrieving samples with a syringe. Seals are available in a variety of colors for easy sample identification.

Shelf Pack - 100 pieces; Case Pack - 1000 pieces

Cat. No.	Description
5110-13	13mm Silver Seal, 10mil PTFE
5140-13	13mm Silver Seal, Clear PTFE/Red Rubber
5146-13	13mm Silver Seal, PTFE/Butyl Rubber, 0.060" Thick
5150-13	13mm Silver Seal, PTFE/Silicone
515075-13	13mm Silver Seal, PTFE/Silicone, 0.075" Thick
5156-13	13mm Silver Seal, PTFE/Silicone, 0.060" Thick
5160-13	13mm Silver Seal, PTFE/Silicone/PTFE
5190-13	13mm Silver Seal, Black Viton®

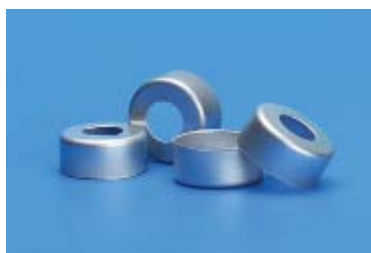
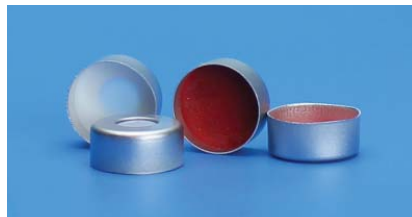

5100-13

Aluminum Seals, Unlined

Case Pack - 1000 pieces

Cat. No.	Description
5100-13*	11mm Silver Seal

* Available in bulk packaging & additional colors

Limited Volume Inserts

All Glass Inserts are available Silanized.



403BS-638X, 403TS-638, 403-638X

Conical Glass Inserts - Precision-Formed Mandrel Interior

Inserts are available preassembled with a polymer bottom spring or patented Top Spring™. The polymer spring acts as a shock absorber that protects against breakage if the needle bottoms out. The conical design permits complete sample removal.

Case Pack - 100 pieces

Cat. No.	Description
403-638X	300µL Glass Insert, No Spring
403BS-638X	300µL Glass Insert with Bottom Spring
403TS-638	300µL Glass Insert with Patented Top Spring™

Conical Polypropylene Inserts - Precision-Formed Interior

Due to the conical design of the snap plug, limited volume inserts used in the shell vial stay centered and straight allowing for easy sample evacuation.

Shelf Pack - 100 pieces; Case Pack - 1000 pieces

Cat. No.	Description
403P-638	300µL Polypropylene Insert, No Spring
403PBS-638	300µL Polypropylene Insert with Bottom Spring
403PTS-638	300µL Polypropylene Insert with Patented Top Spring™



403PBS-638, 403PTS-638, 403P-638

Snap Ring™ Vials, 15x45mm, 13mm Crimp Finish



405-843

Accessories



Flat Bottom Glass Inserts

Shelf Pack - 100 pieces; Case Pack - 1000 pieces

Cat. No.	Description
405-843	500µL Glass Flat Bottom Insert

Crimpers/Decappers for 13mm Crimp Vials

J.G. Finneran Crimpers and Decappers are designed, and manufactured using quality materials, and finishing techniques to provide a consistent and dependable seal while maintaining their durability, and long life. The standard hand crimpers are provided with an adjustable stop, allowing the operator to repeatedly achieve a quality crimped seal. All parts that contact the crimp seal are stainless steel or plated. The crimper jaws are hardened and polished to provide smooth, consistent operation.

Sold Individually

Cat. No.	Description
9300-13	13mm Hand Operated Crimper
9300-13SS	13mm Hand Operated Crimper, Stainless Steel
9306-13SS	13mm Hand Operated Crimper, Stainless Steel w/Grips
9310-13	13mm Hand Operated Decapper
9320-13	13mm Crimp Type Decapper
9320-13SS	13mm Hand Operated Decapper, Stainless Steel
9326-13SS	13mm Hand Operated Decapper, Stainless Steel w/Grips

Multi-Use Universal Vial Rack™ System

Increased spacing allows the user to pipet samples or attach caps without removing the vials from the rack. Frame is made of glass-reinforced polypropylene and insert trays are made of transparent PETG.

Case Pack - 5 pieces

Cat. No.	Description
9600-01	Universal Vial Rack™, Blue Polypropylene, for Insert Trays
9601-15	25 Position Insert Tray for Universal Vial Rack™ for 15mm Vials



WISP™ Style Screw Thread, 15x45mm, 13-425mm Neck Finish

Finneran Products Certified For Science™

Vials



34013E-1545, 34013-1545,
34013E-1545A, 34013-1545A

Designed to work in Shimadzu and Waters WISP™ 48 position autosamplers. Choose from clear or amber Type I borosilicate glass. Available with graduated marking spots.

Shelf Pack - 100 pieces; Case Pack - 1000 pieces

Cat. No.	Description
34013-1545	4.0mL Clear Vial
34013-1545A	4.0mL Amber Vial
34013E-1545	4.0mL Clear Vial, White Graduation Spot
34013E-1545A	4.0mL Amber Vial, White Graduation Spot
34013-1545Z	4.0mL Clear Vial, Silanized
34013-1545AZ	4.0mL Amber Vial, Silanized



30313TG-1545



33113-1545

Limited Volume Screw Thread Vials

J.G. Finneran is the original designer and manufacturer of the Glass Insert/Plastic Outside Vial (Glastic). Glastic is a unique combination of Type I low extractable borosilicate glass insert and a clear or amber thermoplastic polymer outer vial shell. The glass is the only contact between the sample and the seal.

Glastic - Glass Insert/Plastic Outside Vials

Case Pack - 100 pieces

Cat. No.	Description
30313TG-1545	300µL Glass/Clear Plastic LVV

Glass Specialty Vials

Case Pack - 100 pieces

Cat. No.	Description
33113-1545	3.1mL Clear High Recovery Vial

Polypropylene Screw Thread Vials

Shelf Pack - 100 pieces; Case Pack - 1000 pieces

Cat. No.	Description
31213P-1545	1.2mL Polypropylene Vial
32513P-1545	2.5mL Polypropylene Vial
32913P-1545	2.9mL Polypropylene Vial



31213P-1545



32513P-1545



32913P-1545

WISP™ Style Screw Thread, 15x45mm, 13-425mm Neck Finish

Closures



Open Hole Caps



Closed Top Caps

5330-13

Screw Thread Closures (13-425mm)

Available in a wide assortment of colors. Designed for use with all autosamplers. The Top Seal™ closure with a 10mil molded septa allows for easy needle penetration and is inert to most solvents. The one-piece design saves time by eliminating the process of assembling liners in the closures.

Shelf Pack - 100 pieces; Case Pack - 1000 pieces

Cat. No.	Description
5310-13*	Black, Polypropylene Open Hole Cap
5320-13	Black Polypropylene Unlined Cap, Solid Top
5320-13W	White Polypropylene Unlined Cap, Solid Top
5330-13*	Top Seal™ Closure, Clear Polypropylene, molded 10mil septa
5340-13	Black Polypropylene Glass-Filled Open Hole Closure
5360-13	Solid Top, Black Polypropylene PTFE/F217 Lined Cap
5360-13W	Solid Top, White Polypropylene PTFE/F217 Lined Cap

* Available in bulk packaging and additional colors; (B) Blue, (G) Green, (R) Red, (W) White, and (Y) Yellow

Septa for Screw Thread Closures

Refer to Septa Selection Guide to choose 13mm septa best suited for your application.

Shelf Pack - 100 pieces; Case Pack - 1000 pieces

Cat. No.	Description
601010-13	13mm x 0.010" White PTFE Septa
601081-13	13mm x 0.010" White PTFE Septa w/Star Slit
603090-13	12mm x 0.030" Black Viton® Septa
604040-13	12mm x 0.040" PTFE/Red Rubber Septa
604040-13F	12mm x 0.040" PTFE/Butyl Rubber Septa
604060-13	13mm x 0.040" Red PTFE/Silicone/Red PTFE Septa
604550-13	13mm x 0.045" Red PTFE/Silicone Septa
606040-13	13mm x 0.060" PTFE/Red Rubber Septa
606050-13	13mm x 0.060" Red PTFE/Silicone Septa
606070-13	13mm x 0.060" Red PTFE/Silicone w/Slit Septa
607550-13	13mm x 0.075" Red PTFE/Silicone Septa
607550T-13	13mm x 0.075" Tan PTFE/Silicone Septa



Preassembled Screw Thread Closure and Septa

Choose the preassembled caps with septa best suited for your application. The patented Top Hat™ septa and closure was designed to provide a positive physical lock to assure that preassembled components arrive intact.

Shelf Pack - 100 pieces; Case Pack - 1000 pieces

Cat. No.	Description
804040-13*	Black Closure, PTFE/Red Rubber Septa, 0.040"
804060-13*	Black Closure, PTFE/Silicone/PTFE Septa, 0.040"
806040-13*	Black Closure, PTFE/Red Rubber Septa, 0.060" Lined
806070-13*	Black Closure, Red PTFE/Silicone Septa, 0.060" w/ Slit
806550-13*	Black Closure, Red PTFE/Silicone Septa, 0.065"
806550TH-13	Black Top Hat™ PTFE/Silicone Septa/Closure (Patented)

* Available in additional colors; (B) Blue, (G) Green, (R) Red, (W) White, & (Y) Yellow



806550TH-13

WISP™ Style Screw Thread, 15x45mm, 13-425mm Neck Finish

Limited Volume Inserts

All Glass Inserts are available Silanized.



403BS-638X, 403TS-638, 403-638X

Conical Glass Inserts - Precision-Formed Mandrel Interior

Inserts are available preassembled with a polymer bottom spring or patented TopSpring™. The polymer spring acts as a shock absorber that protects against breakage if the needle bottoms out. The conical design permits complete sample removal.

Case Pack - 100 pieces

Cat. No.	Description
403-638X	300µL Glass Insert, No Spring
403BS-638X	300µL Glass Insert with Bottom Spring
403TS-638	300µL Glass Insert with Patented Top Spring™

Conical Polypropylene Inserts - Precision-Formed Interior

Due to the conical design of the snap plug, limited volume inserts used in the shell vial stay centered and straight allowing for easy sample evacuation.

Shelf Pack - 100 pieces; Case Pack - 1000 pieces

Cat. No.	Description
403P-638	300µL Polypropylene Insert, No Spring
403PBS-638	300µL Polypropylene Insert with Bottom Spring
403PTS-638	300µL Polypropylene Insert with Patented Top Spring™



403PBS-638, 403PTS-638, 403P-638



405-843

Flat Bottom Glass Inserts

Shelf Pack - 100 pieces; Case Pack - 1000 pieces

Cat. No.	Description
405-843	500µL Glass Flat Bottom Insert

WISP™ Style Screw Thread, 15x45mm, 13-425mm Neck Finish

Preassembled Convenience Packs

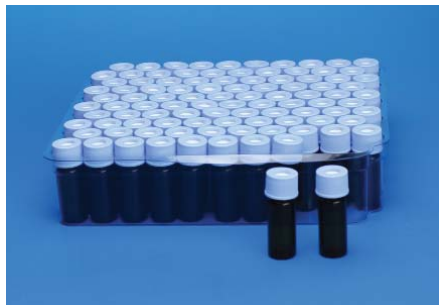

Preassembled Convenience Packs

Components packaged in a tray that fits into bench drawer for easy access. Packaging keeps products visible and particle free. Preassembled packs come ready to use. Closures and septa of your choice are attached to the vials.

Case Pack - 100 pieces

Cat. No.	Description
801010-1545	Clear Vial, Closure, PTFE Septa, 0.010"
801010-1545A	Amber Vial, Closure, PTFE Septa, 0.010"
804040-1545	Clear Vial, Closure, PTFE/Red Rubber Septa, 0.040"
804040-1545A	Amber Vial, Closure, PTFE/Red Rubber Septa, 0.040"
804060-1545	Clear Vial, Closure, PTFE/SIL/PTFE Septa, 0.040"
804060-1545A	Amber Vial, Closure, PTFE/SIL/PTFE Septa, 0.040"
806050-1545	Clear Vial, Closure, Red PTFE/Silicone Septa, 0.060"
806050-1545A	Amber Vial, Closure, Red PTFE/Silicone Septa, 0.060"
806070-1545	Clear Vial, Closure, Red PTFE/Silicone Septa, 0.060", Slit

Any combination of vial, closure and septa is available. Please call.

Convenience Pack



Convenience Packs

Components packaged in a clear lid tray with 100 vials and 100 preassembled closures and septa that fits into bench drawer for easy access. Packaging keeps products visible and particle free. Convenience Packs come ready to use.

Shelf Pack - 100 pieces; Case Pack - 1000 pieces

Cat. No.	Description
9405360W-15	Clear Vial, Solid Top Black Cap, PTFE/F217 Lined
9406550-15	Clear Vial, Black Cap, Red PTFE/Silicone, 0.065"
9406550-15A	Amber Vial, Black Cap, Red PTFE/Silicone, 0.065"

Any combination of vial, closure and septa is available. Please call.

Accessories



Multi-Use Universal Vial Rack™ System

Increased spacing allows the user to pipet samples or attach caps without removing the vials from the rack. Frame is made of glass-reinforced polypropylene and insert trays are made of transparent PETG.

Case Pack - 5 pieces

Cat. No.	Description
9600-01	Universal Vial Rack™, Blue Polypropylene, for Insert Trays
9601-15	25 Position Insert Tray for Universal Vial Rack™ for 15mm Vials

15x45mm Shell Vials, 15mm Plug

Finneran Products Certified For Science™

Vials



4100-1545A, 4100-1545



4100P-1545

Glass Shell Vials

Available in clear or amber Type I borosilicate glass, or polypropylene for easy disposal. Vials feature thicker walls for safer sample handling. Limited volume shell vials have a precisely designed conical bottom which permits maximum sample evacuation.

Shelf Pack - 100 pieces; Case Pack - 1000 pieces

Cat. No.	Description
4100-1545	4.0mL Clear Glass Shell Vial
4100-1545A	4.0mL Amber Glass Shell Vial
4100M-1545	4.0mL Clear Glass Shell Vial with Marking Spot
4100M-1545A	4.0mL Amber Glass Shell Vial with Marking Spot

Polypropylene Shell Vials

Shelf Pack - 100 pieces; Case Pack - 1000 pieces

Cat. No.	Description
4100P-1545	4.0mL Polypropylene Shell Vial
4130P-1545	3.0mL Polypropylene Shell Vial

Closures



5400FT-15

Polyethylene Flat Top Snap Plugs (15mm)

Shelf Pack - 100 pieces; Case Pack - 1000 pieces

Cat. No.	Description
5400FT-15	15mm Clear Polyethylene Flat Top Snap Plug



5410SB-15

Polyethylene Conical Snap Plugs with Starburst (15mm)

Starburst and conical design of the snap plug provides self centering needle penetration guidance as well as better resealability of the plug after use. The pre-scored starburst plug acts as a penetration aid for dull or thick needles. Plug is designed to easily push in and remove from the vial. The tight fit offers good sealability.

Shelf Pack - 100 pieces; Case Pack - 1000 pieces

Cat. No.	Description
5405SB-15*	15mm Clear Polyethylene Starburst Conical Snap Plug
5410SB-15*	15mm Clear Polyethylene Starburst Conical Snap Plug, Pre-Scored

* Available in additional colors; (B) Blue, (G) Green, (R) Red, & (Y) Yellow

Shell Vials, 15x45mm, 15mm Plug

Closures



Multi-Plugs with Safety Sleeve

The Multi-Plug Safety Sleeve is available in clear K-resin or black glass reinforced polypropylene. Use it as a tool to make plug and shell vial assembly easier and safer. The safety sleeve is “Multi” useful because it is designed to work with 1mL, 2mL or 4mL shell vials. One Safety Sleeve works with all three sizes.

Case Pack - 5 pieces

Cat. No.	Description
9200-81215	Multi-Plug Safety Sleeve Clear
9200-81215B	Multi-Plug Safety Sleeve Black

Limited Volume Inserts

All Glass Inserts are available Silanized.

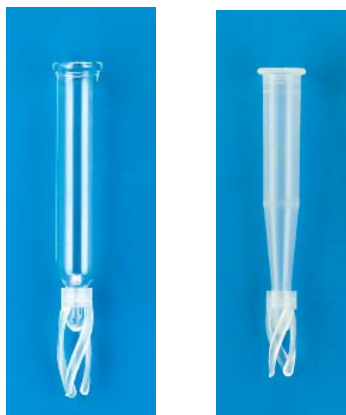

403BS-638X

403PBS-638

Conical Glass Inserts

Inserts are available preassembled with a polymer bottom spring or patented Top Spring™. The polymer spring acts as a shock absorber that protects against breakage if the needle bottoms out. The conical design permits complete sample removal.

Case Pack - 100 pieces

Cat. No.	Description
403BS-638X	300µL Glass Insert w/Bottom Spring

Conical Polypropylene Inserts

Due to the conical design of the snap plug, limited volume inserts used in the shell vial stay centered and straight allowing for easy sample evacuation.

Shelf Pack - 100 pieces; Case Pack - 1000 pieces

Cat. No.	Description
403PBS-638	300µL Polypropylene Insert w/Bottom Spring

Convenience Pack



Convenience Packs with 15x45mm Shell Vials and 15mm Conical Snap Plugs

Components packaged in a clear lid tray with 100 shell vials and 100 conical snap plugs. Snap Plugs are not attached to the vials and are in individual plastic bags. Fits into bench drawer for easy access and packaging keeps products visible and particle-free.

Shelf Pack - 100 pieces; Case Pack - 1000 pieces

Cat. No.	Description
9800-1545	4.0mL Clear Shell Vial & Plug Convenience Pack
9800-1545A	4.0mL Amber Shell Vial & Plug Convenience Pack
9800P-1545	4.0mL Polypropylene Shell Vial & Plug Convenience Pack
9830P-1545	3.0mL Polypropylene Shell Vial & Plug Convenience Pack

Any combination of vial and closure is available. Please call.

Accessories



Multi-Use Universal Vial Rack™ System

Increased spacing allows the user to pipet samples or attach caps without removing the vials from the rack. Frame is made of glass-reinforced polypropylene and insert trays are made of transparent PETG.

Case Pack - 5 pieces

Cat. No.	Description
9600-01	Universal Vial Rack™, Blue Polypropylene, for Insert Trays
9601-15	25 Position Insert Tray for Universal Vial Rack™ for 15mm Vials

Shell Vials for Waters WISP™, 8mm Plug

Finneran Products Certified For Science™

Vials



4100-840, 4100-840A



4107P-840A, 4107P-840



4100-830



4100-843

Designed to work in the Waters WISP™ 96 position autosampler. Available in clear or amber Type I borosilicate glass, or polypropylene for easy disposal. Vials feature thicker walls for safer sample handling. Limited volume shell vials have a precisely designed conical bottom which permits maximum sample evacuation.

8x40mm Glass Shell Vials

Shelf Pack - 100 pieces; Case Pack - 1000 pieces

Cat. No.	Description
4100-840	1.0mL Clear Glass Shell Vial, 8x40mm, Requires Plug
4100-840A	1.0mL Amber Glass Shell Vial, 8x40mm, Requires Plug

8x40mm Polypropylene Shell Vials

Shelf Pack - 100 pieces; Case Pack - 1000 pieces

Cat. No.	Description
4100P-840	1.0mL Polypropylene Shell Vial, 8x40mm, Requires Plug
4107P-840	700µL Polypropylene Limited Volume Shell Vial, 8x40mm, Requires Plug
4107P-840A	700µL Amber Polypropylene Limited Volume Shell Vial, 8x40mm, Requires Plug

8x30mm Glass Shell Vials

Shelf Pack - 100 pieces; Case Pack - 1000 pieces

Cat. No.	Description
4100-830	750µL Clear Shell Vial, 8x30mm, Requires Snap Plug

8x30mm Polypropylene Shell Vials

Shelf Pack - 100 pieces; Case Pack - 1000 pieces

Cat. No.	Description
4100P-830	900µL Polypropylene Shell Vial, 8x30mm, Requires Snap Plug
4105P-830	500µL Polypropylene Shell Vial, 8x30mm, Requires Snap Plug

8x43mm Glass Shell Vials

Shelf Pack - 100 pieces; Case Pack - 1000 pieces

Cat. No.	Description
4100-843	1.0mL Clear Glass Shell Vial, 8x43, Requires Snap Plug

Shell Vials for Waters WISP™, 8x40mm, 8mm Plug

Closures



Polyethylene Snap Plugs with Starburst (8mm)

Starburst and conical design of the snap plug provides self-centering needle penetration guidance as well as better resealability of plug after use. Plug is designed to easily push in and remove from the vial. Tight fit offers good sealability.

Shelf Pack - 100 pieces; Case Pack - 1000 pieces

Cat. No.	Description
5400SB-08*	8mm Clear Polyethylene Snap Plug with Starburst
5400TP-08	8mm Clear PE Easy-Pierce Plug with Pre-Scored Starburst

* Available in additional colors; (B) Blue, (G) Green, (R) Red, & (Y) Yellow



5405SB-08

Polyethylene Conical Snap Plugs with Starburst (8mm)

Shelf Pack - 100 pieces; Case Pack - 1000 pieces

Cat. No.	Description
5405SB-08*	8mm Clear Polyethylene Starburst Conical Snap Plug

* Available in additional colors; (B) Blue, (G) Green, (R) Red, & (Y) Yellow



5400-08

Polyethylene Snap Plugs and Lined Snap Plugs (8mm)

Shelf Pack - 100 pieces; Case Pack - 1000 pieces

Cat. No.	Description
5400-08	8mm Clear Polyethylene Snap Plug, No Starburst
540030-08	8mm Clear Polyethylene, Silicone Lined, Snap Plug
5450-08	8mm Snap Plug, PTFE/Silicone

Multi-Plugs with Safety Sleeve

The Multi-Plug Safety Sleeve is available in clear K-resin or black glass reinforced polypropylene. Use it as a tool to make plug and shell vial assembly easier and safer. The safety sleeve is “Multi” useful because it is designed to work with 1mL, 2mL or 4mL shell vials. One Safety Sleeve works with all three sizes.

Case Pack - 5 pieces

Cat. No.	Description
9200-81215	Multi-Plug Safety Sleeve, Clear
9200-81215B	Multi-Plug Safety Sleeve, Black



Shell Vials for Waters WISP™, 8x40mm, 8mm Plug

Limited Volume Inserts

All Glass Inserts are available Silanized.

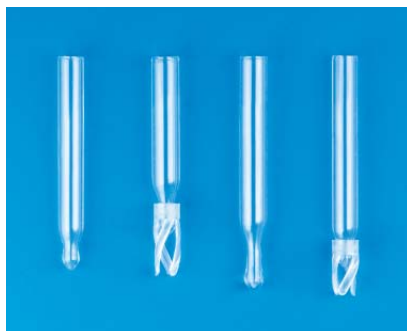

402-536, 4025BS-629, 4025-540, 402BS-536

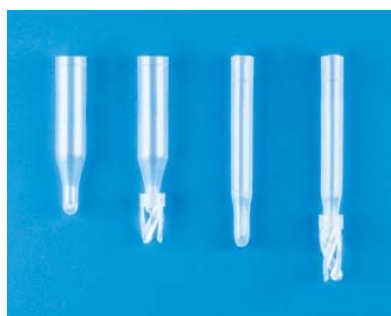

402P-536, 402PBS-536, 4025P-631, 402PBS-536

Convenience Packs



Conical Glass Inserts - Precision-Formed Mandrel Interior

Due to the conical design of the snap plug, limited volume inserts used in the shell vial stay centered and straight allowing for easy sample evacuation.

Case Pack - 100 pieces

Cat. No.	Description
4015BS-529	150µL Glass Insert w/Bottom Spring
402-536	200µL Glass Insert, No Spring
402BS-536	200µL Glass Insert with Bottom Spring
4025-629	250µL Glass Big Mouth Insert, No Spring
4025BS-629	250µL Glass Big Mouth Insert with Bottom Spring
4025-540	250µL Glass Insert, No Spring

Conical Polypropylene Inserts - Precision-Formed Mandrel Interior

Shelf Pack - 100 pieces; Case Pack - 1000 pieces

Cat. No.	Description
402P-536	200µL Polypropylene Insert, No Spring
402PBS-536	200µL Polypropylene Insert with Bottom Spring
4025P-631	250µL Polypropylene Big Mouth Insert, No Spring
4025P-631BK	250µL Black Polypropylene Big Mouth Insert, No Spring
4025PBS-631	250µL Polypropylene Big Mouth Insert with Bottom Spring
425PBS-631BK	250µL Black Polypropylene Big Mouth Insert w/Bottom Spring

Convenience Packs with Shell Vials and 8mm Plugs

Components packaged in a clear lid tray with 100 shell vials and 100 conical snap plugs. Snap Plugs are not attached to the vials and are in individual plastic bags. Fits into bench drawer for easy access and packaging keeps products visible and particle free.

Shelf Pack - 100 pieces; Case Pack - 1000 pieces

Cat. No.	Description
9800-830	750µL Clear Shell Vial & Plug Convenience Pack, 8x30mm
9800-840	1.0mL Clear Shell Vial & Plug Convenience Pack, 8x40mm
9800-840A	1.0mL Amber Shell Vial & Plug Convenience Pack, 8x40mm
9800-840XS	1.0mL Clear Shell Vial & Starburst Plug Convenience Pack, 8x40mm
9800-840AXS	1.0mL Amber Shell Vial & Starburst Plug Convenience Pack, 8x40mm
9800P-840	1.0mL Polypropylene Shell Vial & Plug Convenience Pack, 8x40mm
9800TP-840	1.0mL Clear Shell Vial & Easy-Pierce/Pre-Scored Starburst Plug, 8x40mm
9800TP-840A	1.0mL Amber Shell Vial & Easy-Pierce/Pre-Scored Starburst Plug, 8x40mm
9807P-840	700µL Polypropylene Limited Volume Shell Vial & Plug Convenience Pack

Convenience Packs with Shell Vials and 8mm Plugs

Shelf Pack - 200 pieces; Case Pack - 1000 pieces

Cat. No.	Description
9802-840	1.0mL Clear Shell Vial & Plug Convenience Pack, 8x40mm
9802-840XS	1.0mL Clear Shell Vial & Starburst Plug Convenience Pack, 8x40mm

Any combination of shell vials and snap plugs are available. Please call.

Dram & Sample Storage Vials

Finneran Products Certified For Science™

Vials



Dram Vials

Clear and amber dram sample vials are made of Type I borosilicate glass, providing exceptional resistance to heat shock and chemical leaching. Finneran dram vials are available precleaned, precleaned/certified, and silanized.

Shelf Pack - 100 pieces; Case Pack - 1000 pieces

Cat. No.	Description
32008-1235	½ Dram, 12x35mm Clear Vial, 8-425mm Thread
32008-1235A	½ Dram, 12x35mm Amber Vial, 8-425mm Thread
32008E-1235	½ Dram, 12x35mm Clear Vial w/Grad. Spot, 8-425mm Thread
32008E-1235A	½ Dram, 12x35mm Amber Vial w/Grad. Spot, 8-425mm Thread
34013-1545	1 Dram, 15x45mm Clear Vial, 13-425mm Thread
34013-1545A	1 Dram, 15x45mm Amber Vial, 13-425mm Thread
38015-1760	2 Dram, 17x60mm Clear Vial, 15-425mm Thread
38015-1760A	2 Dram, 17x60mm Amber Vial, 15-425mm Thread
312015-1965	3 Dram, 19x65mm Clear Vial, 15-425mm Thread
312015-1965A	3 Dram, 19x65mm Amber Vial, 15-425mm Thread
316018-2170	4 Dram, 21x70mm Clear Vial, 18-400mm Thread
316018-2170A	4 Dram, 21x70mm Amber Vial, 18-400mm Thread
324020-2385	6 Dram, 23x85mm Clear Vial, 20-400mm Thread
324020-2385A	6 Dram, 23x85mm Amber Vial, 20-400mm Thread
332022-2595	8 Dram, 25x95mm Clear Vial, 22-400mm Thread

All Glass Vials are available Silanized.

Sample Storage Vials



Cat. No.	Description
32513-1528	2.5mL Clear Vial, 15x28mm, 13-425mm Thread, 100 per shelf pack, 1000 per case
36015-1940	6.0mL Clear Vial, 19x40mm, 15-425mm Thread, 100 per shelf pack, 1000 per case
36015-1940A	6.0mL Amber Vial, 19x40mm, 15-425mm Thread, 100 per shelf pack, 1000 per case
320024-2856	20mL Clear Vial, 28x56mm, 24-400mm Thread, 144 per case
320024-2856A	20mL Amber Vial, 28x56mm, 24-400mm Thread, 144 per case
330024-2872	30mL Clear Vial, 28x72mm, 24-400mm Thread, 144 per case
340024-2895	40mL Clear Vial, 28x95mm, 24-400mm Thread, 144 per case
340024-2895A	40mL Amber Vial, 28x95mm, 24-400mm Thread, 144 per case
36024-27140	60mL Clear Vial, 27x140mm, 24-400mm Thread, 144 per case
36024-27140A	60mL Amber Vial, 27x140mm, 24-400mm Thread, 144 per case

All Glass Vials are available Silanized.

Dram & Sample Storage Vials

Septa & Closures



Septa for Dram Vial Closures

Shelf Pack - 100 pieces; Case Pack - 1000 pieces

Cat. No.	Description
601010-08	8mm x 0.010" White PTFE Septa
601010-13	13mm x 0.010" White PTFE Septa
601010-20	20mm x 0.010" White PTFE Septa
606050-24	22.5mm x 0.060" PTFE/Silicone Septa
606050G-13	13mm x 0.060" Gray PTFE/Silicone Septa
606050G-15	15mm x 0.060" Gray PTFE/Silicone Septa
606050G-18	18mm x 0.060" Gray PTFE/Silicone Septa
606050G-20	20mm x 0.060" Gray PTFE/Silicone Septa
610050-20	20mm x 0.100" PTFE/Silicone Septa
610050-22	22mm x 0.100" PTFE/Silicone Septa
610050-24	22.5mm x 0.100" PTFE/Silicone Septa
612550-24	22.5mm x 0.125" PTFE/Silicone Septa

Screw Thread Closures

Shelf Pack - 100 pieces; Case Pack - 1000 pieces

Cat. No.	Description
5310-08*	8-425mm Black, Polypropylene Open Hole Cap
5310-13*	13-425mm Black, Polypropylene Open Hole Cap
5310-15*	15-425mm Black, Polypropylene Open Hole Cap
5310-15W	15-425mm White, Polypropylene Open Hole Cap
5310-18*	18-400mm Black, Polypropylene Open Hole Cap
5310-20	20-400mm Black, Polypropylene Open Hole Cap
5310-22	22-400mm Black, Polypropylene Open Hole Cap
5310-24*	24-400mm Black, Polypropylene Open Hole Cap
5310-24414*	24-414mm Black, Polypropylene Open Hole Cap
5320-08	8-425mm Solid Top, Black Polypropylene Unlined
5320-08W	8-425mm Solid Top, White Polypropylene Unlined
5320-13	13-425mm Solid Top, Black Polypropylene Unlined
5320-13W	13-425mm Solid Top, White Polypropylene Unlined
5320-15	15-425mm Solid Top, Black Polypropylene Unlined
5320-15W	15-425mm Solid Top, White Polypropylene Unlined
5320-18	18-400mm Solid Top, Black Polypropylene Unlined
5320-20	20-400mm Solid Top, Black Polypropylene Unlined
5320-24*	24-400mm Solid Top, Black Polypropylene Unlined
5320-24414	24-414mm Solid Top, Black Polypropylene Unlined
5320-24414W	24-414mm Solid Top, White Polypropylene Unlined
5340-13	13-425mm Black, Glass Filled Polypropylene Open Hole Cap
5340-24	24-400mm Black, Glass Filled Polypropylene Open Hole Cap

* Available in additional colors; (B) Blue, (G) Green, (R) Red, (W) White, and (Y) Yellow



Dram & Sample Storage Vials

Screw Thread Closures - con't.



Green Ribbed Thermoset Solid Top,
PTFE/F217 Lined

Shelf Pack - 100 pieces; Case Pack - 1000 pieces

Cat. No.	Description
5360-08*	8-425mm Solid Top, Black Polypropylene PTFE/F217 Lined
5360-13	13-425mm Solid Top, Black Polypropylene PTFE/F217 Lined
5360-13W	13-425mm Solid Top, White Polypropylene PTFE/F217 Lined
5360-15	15-425mm Solid Top, Black Polypropylene PTFE/F217 Lined
5360-15W	15-425mm Solid Top, White Polypropylene PTFE/F217 Lined
5360-18	18-400mm Solid Top, Black Polypropylene PTFE/F217 Lined
5360-18W	18-400mm Solid Top, White Polypropylene PTFE/F217 Lined
5360-20	20-425mm Solid Top, Black Polypropylene PTFE/F217 Lined
5360PH-08G	8-425mm Green Ribbed Thermoset Solid Top, PTFE/F217 Lined, 500 per case
B5360PH-08G	8-425mm Green Ribbed Thermoset Solid Top, PTFE/F217 Lined, 1000 bulk case
5360PH-13G	13-425mm Green Ribbed Thermoset Solid Top, PTFE/F217 Lined, 500 per case
B5360PH-13G	13-425mm Green Ribbed Thermoset Solid Top, PTFE/F217 Lined, 1000 bulk case
5360PH-15G	15-425mm Green Ribbed Thermoset Solid Top, PTFE/F217 Lined, 500 per case
5360PH-18G	18-400mm Green Ribbed Thermoset Solid Top, PTFE/F217 Lined, 500 per case
B5360PH-18G	18-400mm Green Ribbed Thermoset Solid Top, PTFE/F217 Lined, 1000 bulk case
5360PH-20G	20-400mm Green Ribbed Thermoset Solid Top, PTFE/F217 Lined, 500 per case
B5360PH-20G	20-400mm Green Ribbed Thermoset Solid Top, PTFE/F217 Lined, 1000 bulk case
5360PH-24G	24-400mm Green Ribbed Thermoset Solid Top, PTFE/F217 Lined, 500 per case
B5360PH-24G	24-400mm Green Ribbed Thermoset Solid Top, PTFE/F217 Lined, 1000 bulk case
806550-15	15-425mm Black Open Hole PP Closure, PTFE/Silicone Septa, 0.065"
8200501-20	20-400mm Solid Top, Black Polypropylene, Bonded PTFE/Silicone Lined
812550TTH-24	24-400mm Black Top Hat™ [Patented] Closure, PTFE/Silicone, 100 per csse.
34-375BLK	24-414mm Black PP Open Hole Cap, Bonded 0.060" PTFE/Silicone, 100 per case
34-527	24-414mm White PP Open Hole Cap, Bonded 0.125" PTFE/Silicone, 100 per case
34-527/144	24-414mm White PP Open Hole Cap, Bonded 0.125" PTFE/Silicone, 144 per case
34-527BLK	24-414mm Black PP Open Hole Cap, Bonded 0.125" PTFE/Silicone, 100 per case
34-527/M	24-414mm White PP Open Hole Cap, Bonded 0.125" PTFE/Silicone, 1000 per case
38-375	24-414mm White PP Open Hole Cap, Bonded 0.060" PTFE/Silicone
38-375/100	24-414mm White PP Open Hole Cap, Bonded 0.060" PTFE/Silicone, 100 per case

* Available in additional colors; (B) Blue, (G) Green, (R) Red, (W) White, and (Y) Yellow

Dram & Sample Storage Vials

Preassembled Convenience Packs

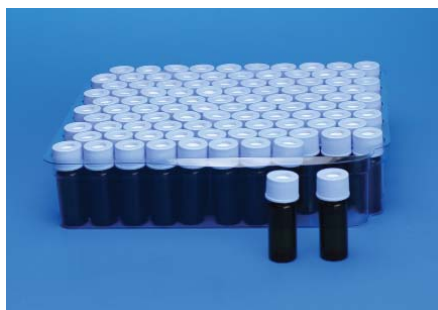

Preassembled Convenience Packs

Dram vials assembled with polypropylene closures and septa.

Case Pack - 100 pieces

Cat. No.	Description
82020-1232	1/2 Dram, 12x32mm Clear Vial, 8-425mm Black Solid Top, PTFE/F217 Lined
82020-1232A	1/2 Dram, 12x32mm Amber Vial, 8-425mm Black Solid Top, PTFE/F217 Lined
82020-1235	1/2 Dram, 12x35mm Clear Vial, 8-425mm Black Solid Top, PTFE/F217 Lined
82020-1235A	1/2 Dram, 12x35mm Amber Vial, 8-425mm Black Solid Top, PTFE/F217 Lined
84020-1545	1 Dram, 15x45mm Clear Vial, 13-425mm Black Solid Top, PTFE/F217 Lined
84020-1545A	1 Dram, 15x45mm Amber Vial, 13-425mm Black Solid Top, PTFE/F217 Lined
84020W-1545	1 Dram, 15x45mm Clear Vial, 13-425mm White Solid Top, PTFE/F217 Lined
84020W-1545A	1 Dram, 15x45mm Amber Vial, 13-425mm White Solid Top, PTFE/F217 Lined
88020-1760	2 Dram, 17x60mm Clear Vial, 15-425mm Black Solid Top, PTFE/F217 Lined
88020-1760A	2 Dram, 17x60mm Amber Vial, 15-425mm Black Solid Top, PTFE/F217 Lined
88020W-1760	2 Dram, 17x60mm Clear Vial, 15-425mm White Solid Top, PTFE/F217 Lined
88020W-1760A	2 Dram, 17x60mm Amber Vial, 15-425mm White Solid Top, PTFE/F217 Lined
88030-1760	2 Dram, 17x60mm Clear Vial, 15-425mm Black Open Hole, PTFE/SIL Lined
88030-1760A	2 Dram, 17x60mm Amber Vial, 15-425mm Black Open Hole, PTFE/SIL Lined
88030W-1760	2 Dram, 17x60mm Amber Vial, 15-425mm Black Open Hole, PTFE/SIL Lined
88040-1760	2 Dram, 17x60mm Clear Vial, 15-425mm Phenolic Cap Poly Seal Cone Lined
812020-1965	3 Dram, 19x65mm Clear Vial, 15-425mm Black Solid Top, PTFE/F217 Lined
812020W-1965	3 Dram, 19x65mm Clear Vial, 15-425mm White Solid Top, PTFE/F217 Lined
812020-1965A	3 Dram, 19x65mm Amber Vial, 15-425mm Black Solid Top, PTFE/F217 Lined
812030-1965	3 Dram, 19x65mm Clear Vial, 15-425mm Black Open Hole Top, PTFE/SIL Lined
812030-1965A	3 Dram, 19x65mm Amber Vial, 15-425mm Black Open Hole Top, PTFE/SIL Lined
816020-2170	4 Dram, 21x70mm Clear Vial, 18-400mm Black Solid Top, PTFE/F217 Lined
816020-2170A	4 Dram, 21x70mm Amber Vial, 18-400mm Black Solid Top, PTFE/F217 Lined
816030-2170	4 Dram, 21x70mm Clear Vial, 18-400mm Black Open Hole Top, PTFE/SIL Lined
816030-2170A	4 Dram, 21x70mm Amber Vial, 18-400mm Black Open Hole Top, PTFE/SIL Lined
824010-2385	6 Dram, 23x85mm Clear Vial, 20-400mm Black Solid Top, PTFE Lined
824010-2385A	6 Dram, 23x85mm Amber Vial, 20-400mm Black Solid Top, PTFE Lined
82401W-2385A	6 Dram, 23x85mm Amber Vial, 20-400mm White Solid Top, PTFE Lined
824020-2385	6 Dram, 23x85mm Clear Vial, 20-400mm Black Solid Top, PTFE/F217 Lined
824020W-2385	6 Dram, 23x85mm Clear Vial, 20-400mm White Solid Top, PTFE/F217 Lined
824020-2385A	6 Dram, 23x85mm Amber Vial, 20-400mm Black Solid Top, PTFE/F217 Lined
824030-2385	6 Dram, 23x85mm Clear Vial, 20-400mm Black Open Hole Top, PTFE/SIL Lined
824030-2385A	6 Dram, 23x85mm Amber Vial, 20-400mm Black Open Hole Top, PTFE/SIL Lined

Headspace Vials and Accessories

Finneran Products Certified For Science™

Vials



Flat Bottom Crimp Headspace Vials



Flat Bottom Threaded Headspace Vials



Round Bottom Crimp Headspace Vials



Round Bottom Threaded Headspace Vials

Headspace vials and closures must form a analysis with reproducible results. Available in clear or amber Type I borosilicate glass with crimp or screw thread finishes. The vials are used to heat the sample until the concentration of the liquid and gas phases are in equilibrium. A sample is then taken from the gas phase (headspace) for analysis.

Standard Headspace Vials with Flat Bottoms

Use in Agilent, DANL, Fisons, Perkin Elmer and Shimadzu

Shelf Pack - 100 pieces; Case Pack - 1000 pieces

Cat. No.	Description
36020-2238	6mL Clear Vial, 22x38mm, 20mm Beveled Edge Crimp
36020X-2238	6mL Clear Vial, 22x38mm, 20mm Flat Top Crimp
310020-2346	10mL Clear Vial, 23x46mm, 20mm Beveled Edge Crimp
310020-2346A	10mL Amber Vial, 23x46mm, 20mm Beveled Edge Crimp
320020-2375	20mL Clear Vial, 23x75mm, 20mm Beveled Edge Crimp
320020-2375A	20mL Amber Vial, 23x75mm, 20mm Beveled Edge Crimp
320020X-2375	20mL Clear Vial, 23x75mm, Flat Bottom, 20mm Flat Top Crimp
327020-3060	27mL Clear Vial, 30x60mm (for Shimadzu), 20mm Crimp
310018F-2346	10mL Clear Flat Bottom Vial, 23x46mm, 18mm Thread
31018F-2346A	10mL Amber Flat Bottom Vial, 23x46mm, 18mm Thread
315018F-2360	15mL Clear Flat Bottom Vial, 23x60mm, 18mm Thread
320018F-2375	20mL Clear Flat Bottom Vial, 23x75mm, 18mm Thread
32018F-2375A	20mL Amber Flat Bottom Vial, 23x75mm, 18mm Thread

All Glass Vials are available Silanized.

Headspace Vials with Rounded Bottoms

Use in Perkin Elmer, Tekmar, CTC PAL, and Varian

Shelf Pack - 100 pieces; Case Pack - 1000 pieces

Cat. No.	Description
310020A-2346	10mL Clear Vial, 23x46mm, 20mm Beveled Edge Crimp
31020A-2346A	10mL Amber Vial, 23x46mm, 20mm Beveled Edge Crimp
320020A-2375	20mL Clear Vial, 23x75mm, 20mm Beveled Edge Crimp
32020AX-2375	20mL Clear Vial, 23x75mm, 20mm Flat Top Crimp
32020A-2375A	20mL Amber Vial, 23x75mm, 20mm Beveled Edge Crimp
322AXLN-2375	20mL Clear Vial, 20mm Flat Top Crimp, Long Neck
310018R-2346	10mL Clear Rounded Bottom Vial, 23x46mm, 18mm Thread
31018R-2346A	10mL Amber Rounded Bottom Vial, 23x46mm, 18mm Thread
320018R-2375	20mL Clear Rounded Bottom Vial, 23x75mm, 18mm Thread
32018R-2375A	20mL Amber Rounded Bottom Vial, 23x75mm, 18mm Thread

All Glass Vials are available Silanized.

Headspace Vials and Accessories

Vials



SPME Vials

SPME Specialty Vials with 20mm Crimp Top and Rounded Bottoms

The new Finneran SPME Vials, with a thicker lip, are ideal for most SPME applications. The thicker lip vial creates a tighter seal on the vial. The Finneran SPME Vials are manufactured from high quality Type 1 borosilicate glass. This new thicker lip vial is available in 10mL and 20mL capacities. To complete the package, Finneran offers the 20mm gold magnetic seal, 8mm hole with a thin 0.60" PTFE/silicone seal. The thin seal is a perfect choice for SPME applications.* The thin seal extends the life of the needle and is available in blue or clear.

Shelf Pack - 100 pieces; Case Pack - 1000 pieces

Cat. No.	Description
31020SP-2346	10mL SPME Clear Vial, 20mm Flat Top Crimp, Thicker Lip Finish
32020SP-2375	20mL SPME Clear Vial, 20mm Flat Top Crimp, Thicker Lip Finish

Closures



20mm Center Tear Seals for Headspace Vials

Aluminum Seals, Unlined

Case Pack - 1000 pieces

Cat. No.	Description
5100-20*	20mm Silver Seal
5100CT-20*	20mm Center Tear Silver Seal
5100TA-20*	20mm Total Tear Away Silver Seal

* Available in bulk packaging & additional colors

Aluminum Seals, Lined

Shelf Pack - 100 pieces; Case Pack - 1000 pieces

Cat. No.	Description
5110-20	20mm Silver Seal, 10mil PTFE
5140-20	20mm Silver Seal, 0.131" PTFE/Gray Butyl Rubber
5142-20	20mm Silver Seal, PharmaFix Molded Gray PTFE/Black Butyl Lined, 100/cs.
5150-20*	20mm Silver Seal, 0.125" PTFE/Silicone
5150B-20	20mm Silver Seal, 8mm Hole, 0.125" PTFE/Blue Silicone, 100/cs.
5150HT-20	20mm Silver Seal, 3mm Tan PTFE/White Silicone, Ultra Clean, Septa for High Temperatures up to 250° C, 100/cs.

* Available in additional colors; (B) Blue, (G) Green, (R) Red, and (G) Gold



5142-20

Aluminum Seals - Pressure Release (20mm)

Case Pack - 100 pieces

Cat. No.	Description
5141PR-20	20mm Silver Pressure Release Seal, 0.131" PTFE/Molded Gray Butyl
5142PR-20	20mm Silver Pressure Release Seal, 0.140" PTFE/Rubber PharmaFix Septa
5143PR-20	20mm Silver Pressure Release Seal, 0.100" PTFE/Silicone

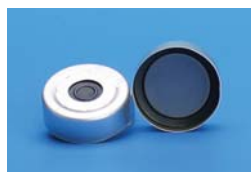

5142PR-20

Aluminum Seals - Low Bleed Septa

Case Pack - 100 pieces

Cat. No.	Description
5150LB-20	20mm Silver Seal, 0.125" Natural PTFE/Clear Silicone, Low Bleed Septa

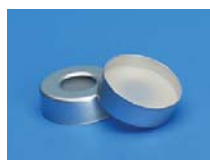

5150LB-20

Aluminum Seals - Ultra Low Bleed Septa

Shelf Pack - 100; Case Pack - 1000 pieces

Cat. No.	Description
5150UL-20	20mm Silver Seal, 3mm Thick Clear PTFE/Blue Silicone Septa



5150UL-20

Headspace Vials and Accessories

Closures

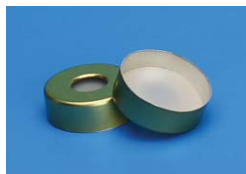

20mm Tin Plate Magnetic Closures



20mm Tin Plate Magnetic Closures for SPME



20mm BiMetal Magnetic Closures

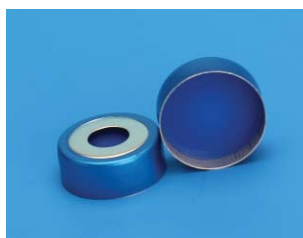

20mm BiMetal Ultra Low Bleed Closures



18mm Metal Threaded Closures

Tin Plate Seals - Magnetic (20mm)

Case Pack - 100 pieces

Cat. No.	Description
----------	-------------

5144TP5-20	20mm Gold Magnetic Seal, 5mm Hole, 0.131" PTFE/Butyl Rubber
------------	---

5144TP8-20	20mm Gold Magnetic Seal, 8mm Hole, 0.131" PTFE/Butyl Rubber
------------	---

5145TP5-20	20mm Gold Magnetic Seal, 5mm Hole, 0.100" PTFE/Silicone
------------	---

5145TP8-20	20mm Gold Magnetic Seal, 8mm Hole, 0.100" PTFE/Silicone
------------	---

5145BTP5-20	20mm Gold Magnetic Seal, 5mm Hole, 0.125" Natural PTFE/Blue Silicone
-------------	--

5145BTP8-20	20mm Gold Magnetic Seal, 8mm Hole, 0.125" Natural PTFE/Blue Silicone
-------------	--

5150BTP8-20	20mm Gold Magnetic Seal, 8mm Hole, 0.125" Clear PTFE/Clear Blue Silicone
-------------	--

Tin Plate Seals for SPME - Magnetic (20mm)

The thin septa extends the life of the needle and allows for a tight seal when using with SPME thicker lip vials. Suitable for Gerstal MPS, CTC and Leap autosamplers with SPME option.

Case Pack - 100 pieces

Cat. No.	Description
----------	-------------

5145TP8-20SP	20mm Gold Tin Seal, 8mm Hole, Thin 0.060" Blue PTFE/White Silicone
--------------	--

5156TP8-20SP	20mm Gold Magnetic Seal, 8mm Hole, Thin 0.060" PTFE/Clear Silicone
--------------	--

BiMetal Seals - Magnetic (20mm)

Case Pack - 100 pieces

Cat. No.	Description
----------	-------------

5150BM00-20R	20mm Red BiMetal Seal, 0.100" PTFE/Silicone
--------------	---

5150BM00-20B	20mm Blue BiMetal Seal, 0.100" PTFE/Silicone
--------------	--

5150BM18-20R	20mm Red BiMetal Seal, 0.118" PTFE/Silicone
--------------	---

5150BM18-20B	20mm Blue BiMetal Seal, 0.118" PTFE/Silicone
--------------	--

BiMetal Seals - Ultra Low Bleed

The BiMetal Seal is comprised of tin and aluminum materials. The outer surface (red or blue) is aluminum and the inner diameter is a silver tin.

Shelf Pack - 100; Case Pack - 1000 pieces

Cat. No.	Description
----------	-------------

5150BMUL-20B	20mm Blue BiMetal Seal, 3mm Thick Clear PTFE/Blue Silicone Septa
--------------	--

Magnetic (Metal) Threaded Closures (18mm)

Case Pack - 100 pieces

Cat. No.	Description
----------	-------------

5350-18M	18mm Silver Magnetic (Metal) Closure, 0.075" Red PTFE/Silicone Liner (Shore A45)
----------	--

535050-18M	18mm Silver Magnetic (Metal) Closure, 0.050" Red PTFE/Silicone Liner (Shore A45), Ultra Low Bleed
------------	---

535050TB-18M	18mm Silver Magnetic (Metal) Closure, 0.050" White PTFE/Translucent Blue Silicone (Shore A45), Ultra Low Bleed
--------------	--

5351TB-18M	18mm Silver Magnetic (Metal) Closure, Translucent Blue 0.125" PTFE/Silicone (Shore A45)
------------	---

5356B-18M	18mm Silver Magnetic (Metal) Closure, 0.060" Blue PTFE/Silicone (Shore A45)
-----------	---

535655B-18M	18mm Silver Magnetic (Metal) Closure, 0.060" Blue PTFE/White Silicone Liner (Shore A55), Ultra Low Bleed
-------------	--

Headspace Vials and Accessories

Septa

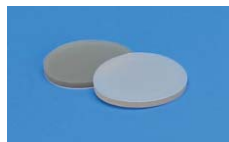

612550-20LB

Septa for 18mm Magnetic Threaded Closures

Shelf Pack - 100 pieces; Case Pack - 1000 pieces

Cat. No.	Description
605050-18M	17.5mm x 0.050" Red PTFE/Silicone Septa
606050B-18M	17.5mm x 0.060" Blue PTFE/Silicone Septa
612550TB-18M	17.5mm x .125" Translucent Blue PTFE/Silicone Septa

Septa for 20mm Aluminum Seals

Shelf Pack - 100 pieces; Case Pack - 1000 pieces

Cat. No.	Description
606050-20S	19mm x 0.060" Gray PTFE/Silicone Septa
612550-20S	19mm x 0.125" Natural PTFE/Silicone Septa
614040-20F	20mm x 0.140" PTFE/Butyl Rubber PharmaFix Septa

Low Bleed Septa for 20mm Aluminum Seals

Case Pack - 100 pieces

Cat. No.	Description
612550-20LB	19mm x 0.125" Thick Natural PTFE/Red Low Bleed Silicone Septa

Ultra Low Bleed Septa for 20mm Aluminum Seals

Case Pack - 100 pieces

Cat. No.	Description
612550-20ULB	19mm x 0.125" Natural PTFE/Blue Ultra Low Bleed Silicone Septa

Stoppers



5001SW-20G

Snap On and Straight Wall Stoppers

Case Pack - 1000 pieces

Cat. No.	Description
5001-20ST	20mm Gray Chlorobutyl Snap On Stopper, Siliconized
5001SW-20G	20mm Gray Chlorobutyl Straight Wall Stopper

Accessories



Crimpers/Decappers

J.G. Finneran Crimpers and Decappers are designed, and manufactured using quality materials, and finishing techniques to provide a consistent and dependable seal while maintaining their durability, and long life. The standard hand crimpers are provided with an adjustable stop, allowing the operator to repeatedly achieve a quality crimped seal. All parts that contact the crimp seal are stainless steel or plated. The crimper jaws are hardened and polished to provide smooth, consistent operation.

Sold Individually

Cat. No.	Description
9300-20	20mm Hand Operated Crimper
9300-20SS	20mm Hand Operated Crimper, Stainless Steel
9306-20SS	20mm Hand Operated Crimper, Stainless Steel w/Grips
9310-20	20mm Hand Operated Decapper
9320-20	20mm Crimp Type Decapper
9320-20SS	20mm Hand Operated Decapper, Stainless Steel
9326-20SS	20mm Hand Operated Decapper, Stainless Steel w/Grips

Injection Port GC Septa

Finneran Products Certified For Science™

General Purpose Blue Silicone Septa



- Suitable for GC analysis
- Up to 150 injections
- Maximum temperature up to 250°C

Packaged in Glass Jars - 100 pieces per Jar

Cat. No.	Description
606GPB-9.5	3mm Thick, GC Septa, 9.5mm (3/8") Diameter
606GPB-11	3mm Thick, GC Septa, 11mm (7/16") Diameter
606GPB-17	3mm Thick, GC Septa, 17mm (21/32") Diameter

General Purpose White Low Bleed Septa



- Suitable for GC analysis
- Lifetime of over 100 injections
- Maximum temperature up to 250°C

Packaged in Glass Jars - 100 pieces per Jar

Cat. No.	Description
606GPW-9.5	3mm Thick, Milky White Low Bleed GC Septa, 9.5mm (3/8") Diameter
606GPW-11	3mm Thick, Milky White Low Bleed GC Septa, 11mm (7/16") Diameter
606GPW-17	3mm Thick, Milky White Low Bleed GC Septa, 17mm (21/32") Diameter

ThermoRed High Temp Ultra Low Bleed Septa



- Suitable for GC and GC/MS applications
- Lowest bleed performance
- Long Life - 450 injections minimum
- Maximum temperature up to 400°C

Packaged in Glass Jars - 25 pieces per Jar

Cat. No.	Description
606550BTO-9	3mm Thick, Red High Temp Ultra Low Bleed GC Septa, 9mm Diameter
606550BTO-9.5	3mm Thick, Red High Temp Ultra Low Bleed GC Septa, 9.5mm (3/8") Diameter
606550BTO-11	3mm Thick, Red High Temp Ultra Low Bleed GC Septa, 11mm (7/16") Diameter
606550BTO-17	3mm Thick, Red High Temp Ultra Low Bleed GC Septa, 17mm (21/32") Diameter

Extremely Low Bleed Septa



- Excellent resealing properties
- Extreme low bleed performance
- Easily penetrated by syringe needle
- Maximum temperature up to 350°C

Packaged in Glass Jars - 25 pieces per Jar

Cat. No.	Description
606XLB-9.5	3mm Thick, Green High Temp/Low Bleed GC Septa, 9.5mm (3/8") Diameter
606XLB-11	3mm Thick, Green High Temp/Low Bleed GC Septa, 11mm (7/16") Diameter
606XLB-17	3mm Thick, Green High Temp/Low Bleed GC Septa, 17mm (21/32") Diameter

Injection Port GC Septa



HT-X High Performance Septa

- Long Life - 200 injections minimum
- Maximum temperature up to 350°C

Packaged in Glass Jars - 25 pieces per Jar

Cat. No.	Description
606HTX-9.5	3mm Thick, Blue High Temp Low Bleed GC Septa, 9.5mm (3/8") Diameter
606HTX-11	3mm Thick, Blue High Temp Low Bleed GC Septa, 11mm (7/16") Diameter
606HTX-17	3mm Thick, Blue High Temp Low Bleed GC Septa, 17mm (21/32") Diameter



Three Layer Septa

- Excellent sealing properties
- Consists of a layer of red silicone rubber, a layer of soft silicone rubber and a final layer of red silicone rubber
- Maximum temperature up to 300°C

Packaged in Glass Jars - 100 pieces per Jar

Cat. No.	Description
6063L-9.5	3-Layer GC Septa, 9.5mm (3/8") Diameter
6063L-11	3-Layer GC Septa, 11mm (7/16") Diameter
6063L-17	3-Layer GC Septa, 17mm (21/32") Diameter



Four Layer Septa

- Excellent sealing properties
- Consists of a layer of red silicone rubber, a layer of soft silicone rubber and a layer of red silicone rubber with 10-mil PTFE facing
- Maximum temperature up to 225°C

Packaged in Glass Jars - 100 pieces per Jar

Cat. No.	Description
6064L-9.5	4-Layer GC Septa, 9.5mm (3/8") Diameter
6064L-11	4-Layer GC Septa, 11mm (7/16") Diameter
6064L-17	4-Layer GC Septa, 17mm (21/32") Diameter



MicroSep PTFE Lined Septa

- Off-white silicone rubber lined with white PTFE
- Maximum temperature up to 250°C

Packaged in Glass Jars - 25 pieces per Jar

Cat. No.	Description
606MS-9.5	3mm Thick, White PTFE/Off-White Silicone Septa, 9.5mm (3/8") Diameter
606MS-11	3mm Thick, White PTFE/Off-White Silicone Septa, 11mm (7/16") Diameter
606MS-17	3mm Thick, White PTFE/Off-White Silicone Septa, 17mm (21/32") Diameter



MicroSep Low Bleed PTFE Lined Septa

- Cream silicone rubber lined with yellow PTFE
- Maximum temperature up to 250°C

Packaged in Glass Jars - 25 pieces per Jar

Cat. No.	Description
606MSLB-9.5	3mm Thick, Yellow PTFE/Cream Silicone Septa, 9.5mm (3/8") Diameter
606MSLB-11	3mm Thick, Yellow PTFE/Cream Silicone Septa, 11mm (7/16") Diameter
606MSLB-17	3mm Thick, Yellow PTFE/Cream Silicone Septa, 17mm (21/32") Diameter

Injection Port GC Septa



Advanced Green Septa

- *Low bleed performance*
 - *Long Life - up to 100 injections*
 - *Maximum temperature up to 300°C*
- Packaged in Glass Jars - 50 pieces per Jar**

Cat. No.	Description
----------	-------------

606550GR-11	3mm Thick, Green General Purpose Septa, 11mm (7/16") Diameter
-------------	---



Low Bleed Gray Septa

- *Low bleed performance*
 - *Good resealing capability*
 - *Long Life - up to 100 injections*
 - *Maximum temperature up to 200°C*
- Packaged in Glass Jars - 25 pieces per Jar**

Cat. No.	Description
----------	-------------

606550LB-11G	3mm Thick, Gray Low Bleed General Purpose Septa, 11mm (7/16") Diameter
--------------	--



Low Bleed Red Septa

- *Low bleed performance*
 - *Good resealing capability*
 - *Long Life - up to 100 injections*
 - *Maximum temperature up to 300°C*
- Packaged in Glass Jars - 25 pieces per Jar**

Cat. No.	Description
----------	-------------

606550LB-11R	3mm Thick, Red Low Bleed General Purpose Septa, 11mm (7/16") Diameter
--------------	---



Low Bleed Yellow Septa

- *Low bleed performance*
 - *Good resealing capability*
 - *Long Life - up to 100 injections*
 - *Maximum temperature up to 300°C*
- Packaged in Glass Jars - 50 pieces per Jar**

Cat. No.	Description
----------	-------------

612550LB-5Y	5mm Diameter, .125" thick PTFE/Yellow Silicone Low Bleed GC Septa
-------------	---



Long Life Yellow Septa

- *Very low bleed performance*
 - *Excellent adhesion to PTFE substrate*
 - *Ideal for long or overnight runs*
 - *Long Life - up to 200 injections*
 - *Maximum temperature up to 350°C*
- Packaged in Glass Jars - 25 pieces per Jar**

Cat. No.	Description
----------	-------------

606550Y-11	3mm Thick, Long Life Yellow Septa, 11mm (7/16") Diameter
------------	--

Injection Port GC Septa



High Temperature Red GC Septa with Guide Hole

- Lowest bleed performance
- Long Life - 450 injections minimum
- Maximum temperature up to 400°C
- 50 durometer hardness

Packaged in Glass Jars - 50 pieces per Jar

Cat. No.	Description
606GHT-9.5R	3mm Thick, Red High Temp GC Septa with Guide Hole, 9.5mm Diameter
606GHT-10R	3mm Thick, Red High Temp GC Septa with Guide Hole, 10mm Diameter
606GHT-11R	3mm Thick, Red High Temp GC Septa with Guide Hole, 11mm Diameter
606GHT-17R	3mm Thick, Red High Temp GC Septa with Guide Hole, 17mm Diameter

Ultra Low Bleed Purple GC Septa with Guide Hole

- Lowest bleed performance
- Long Life - 450 injections minimum
- Maximum temperature up to 325°C
- 50 durometer hardness
- Septa comes with Guide Hole

Packaged in Glass Jars - 50 pieces per Jar

Cat. No.	Description
606GHP-9.5P	3mm Thick, Purple General Purpose GC Septa, 9.5mm Diameter
606GHP-10P	3mm Thick, Purple General Purpose GC Septa, 10mm Diameter
606GHP-11P	3mm Thick, Purple General Purpose GC Septa, 11mm Diameter
606GHP-17P	3mm Thick, Purple General Purpose GC Septa, 17mm Diameter

Shimadzu Precision Molded Red Plug

- Fits Shimadzu GC's
- Long Life
- Maximum temperature up to 400°C
- 50 durometer hardness

Packaged in Glass Jars - 50 pieces per Jar

Cat. No.	Description
606SP-Plug	Shimadzu Molded Red Plug, Ultra Low Bleed, High Temperature

High Temperature Precision Molded Red Septa

Packaged in Glass Jars - 50 pieces per Jar

Cat. No.	Description
6655BTO-11.5	11.5mm Diameter, .125" Thick, Center Guide Hole

Crimpers and Decappers

Finneran Products Certified For Science™

J.G. Finneran Crimpers and Decappers are designed, and manufactured using quality materials, and finishing techniques to provide a consistent and dependable seal while maintaining their durability, and long life. The standard hand crimpers are provided with an adjustable stop, allowing the operator to repeatedly achieve a quality crimped seal. All parts that contact the crimp seal are stainless steel or plated. The crimper jaws are hardened and polished to provide smooth, consistent operation.

Hand Operated Crimpers and Decappers



Case Pack - 1 piece

Cat. No.	Description
9300-08	8mm Hand Operated Crimper
9300-11	11mm Hand Operated Crimper
9300-13	13mm Hand Operated Crimper
9300-20	20mm Hand Operated Crimper
9310-08	8mm Hand Operated Decapper
9310-11	11mm Hand Operated Decapper
9310-13	13mm Hand Operated Decapper
9310-20	20mm Hand Operated Decapper

Crimp-Type Decappers



Case Pack - 1 piece

Cat. No.	Description
9320-08	8mm Crimp-Type Decapper
9320-11	11mm Crimp-Type Decapper
9320-13	13mm Crimp-Type Decapper
9320-20	20mm Crimp-Type Decapper
9320-32	32mm Crimp-Type Decapper

Stainless Steel Corrosion Resistant Hand Operated Crimpers



Case Pack - 1 piece

Cat. No.	Description
9300-08SS	8mm Stainless Steel Corrosion Resistant Hand Operated Crimper
9300-11SS	11mm Stainless Steel Corrosion Resistant Hand Operated Crimper, Adjustable
9300-13SS	13mm Stainless Steel Corrosion Resistant Hand Operated Crimper, Adjustable
9300-20SS	20mm Stainless Steel Corrosion Resistant Hand Operated Crimper, Adjustable
9300-28SS	28mm Stainless Steel Corrosion Resistant Hand Operated Crimper
9300-30SS	30mm Stainless Steel Corrosion Resistant Hand Operated Crimper, Adjustable
9300-32SS	32mm Stainless Steel Corrosion Resistant Hand Operated Crimper
9306-08SS	8mm Stainless Steel Corrosion Resistant Hand Operated Crimper w/Grips
9306-11SS	11mm Stainless Steel Corrosion Resistant Hand Operated Crimper, Adjustable w/Grips
9306-13SS	13mm Stainless Steel Corrosion Resistant Hand Operated Crimper, Adjustable w/Grips
9306-20SS	20mm Stainless Steel Corrosion Resistant Hand Operated Crimper, Adjustable w/Grips
9306-30SS	30mm Stainless Steel Corrosion Resistant Hand Operated Crimper, Adjustable w/Grips
9306-32SS	32mm Stainless Steel Corrosion Resistant Hand Operated Crimper w/Grips

Crimpers and Decappers

Hand Operated Crimpers For Flip Off Seals

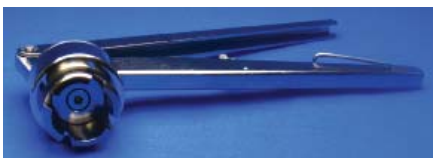

Case Pack - 1 piece

Cat. No.	Description
9300FO-13	13mm Stainless Steel Corrosion Resistant Hand Crimper, Adjustable
9300FO-16.5	16.5mm Stainless Steel Corrosion Resistant Hand Crimper
9300FO-20	20mm Stainless Steel Corrosion Resistant Hand Crimper, Adjustable
9300FO-28	28mm Stainless Steel Corrosion Resistant Hand Crimper
9300FO-30	30mm Stainless Steel Corrosion Resistant Hand Crimper
9300FO-32	32mm Stainless Steel Corrosion Resistant Hand Crimper
9306FO-13	8mm Stainless Steel Corrosion Resistant Hand Operated Crimper w/Grips
9306FO-16.5	11mm Stainless Steel Corrosion Resistant Hand Operated Crimper w/Grips
9306FO-20	13mm Stainless Steel Corrosion Resistant Hand Operated Crimper, Adjustable w/Grips
9306FO-28	20mm Stainless Steel Corrosion Resistant Hand Operated Crimper w/Grips
9306FO-32	32mm Stainless Steel Corrosion Resistant Hand Operated Crimper w/Grips
9300FOF-13	13mm Stainless Steel Corrosion Resistant Crimper, Adjustable, w/Flush Sides
9300FOF-20	20mm Stainless Steel Corrosion Resistant Crimper, Adjustable, w/Flush Sides
9306FOF-13	13mm Stainless Steel Corrosion Resistant Crimper, Adjustable, w/Grips, w/Flush Sides
9306FOF-20	20mm Stainless Steel Corrosion Resistant Crimper, Adjustable, w/Grips, w/Flush Sides

Stainless Steel Corrosion Resistant Hand Operated Decappers

Case Pack - 1 piece



Cat. No.	Description
9320-08SS	8mm Stainless Steel Corrosion Resistant Hand Operated Decapper
9320-11SS	11mm Stainless Steel Corrosion Resistant Hand Operated Decapper
9320-13SS	13mm Stainless Steel Corrosion Resistant Hand Operated Decapper
9320-20SS	20mm Stainless Steel Corrosion Resistant Hand Operated Decapper
9320-28SS	28mm Stainless Steel Corrosion Resistant Hand Operated Decapper
9320-30SS	30mm Stainless Steel Corrosion Resistant Hand Operated Decapper
9320-32SS	32mm Stainless Steel Corrosion Resistant Hand Operated Decapper
9326-08SS	8mm Stainless Steel Corrosion Resistant Hand Operated Decapper, with Grips
9326-11SS	11mm Stainless Steel Corrosion Resistant Hand Operated Decapper, with Grips
9326-13SS	13mm Stainless Steel Corrosion Resistant Hand Operated Decapper, with Grips
9326-20SS	20mm Stainless Steel Corrosion Resistant Hand Operated Decapper, with Grips
9326-30SS	30mm Stainless Steel Corrosion Resistant Hand Operated Decapper, with Grips
9326-32SS	32mm Stainless Steel Corrosion Resistant Hand Operated Decapper, with Grips

Crimpers and Decappers



Light weight and easy to operate, our Pneumatic Crimping Tools enable handheld semi-automatic crimping and decapping of vials and bottles with less effort. Interchangeable jaws allow for use with a variety of sizes and types of crimp seals including 8mm, 11mm, 13mm, 13mm flip-off, 20mm and 20mm flip-off. Pneumatic operation provides fast and dependable performance. Lightweight, and evenly balanced Crimp pressure and intensity setting can be quickly and easily adjusted. Crimping cycle time is adjustable between 0.75 seconds and 1.5 seconds, allowing faster completion of crimping job. Corrosion resistant finishes throughout. Tool is manufactured using stainless steel and hard coated corrosion resistant plating. (Autoclaveable models also available.)

Power Crimper



9300-PC



9300-PC-08



9300-PCSFP



9300FO-PC-30

Case Pack - 1 piece

Cat. No.	Description
9300-BC-SPC	Bench Top Crimper - Crimper Head for Spray Pump Caps
9300-PC	Power Crimper Unit, Regulator and Gauge, with 8' Polyurethane Straight Supply Hose
9300-PCSFP	Power Crimper w/Stand, Regulator and Gauge, with 8' Polyurethane Straight Supply Hose
9300-PC-08	8mm Crimper Head For Power Crimper
9300-PC-11	11mm Crimper Head For Power Crimper
9300-PC-13	13mm Crimper Head For Power Crimper
9300-PC-20	20mm Crimper Head For Power Crimper
9300-PC-30	30mm Crimper Head For Power Crimper
9300FO-PC-13	13mm Crimper Head for Flip Off Seals (For Power Crimper)
93FO-PC-16.5	16.5mm Crimper Head for Flip Off Seals (For Power Crimper)
9300FO-PC-20	20mm Crimper Head for Flip Off Seals (For Power Crimper)
9300FO-PC-28	28mm Crimper Head for Flip Off Seals (For Power Crimper)
9300FO-PC-30	30mm Crimper Head for Flip Off Seals (For Power Crimper)
9300FO-PC-32	32mm Crimper Head for Flip Off Seals (For Power Crimper)
9320-PC-08	8mm De-crimper Head (decapper) For Power Crimper
9320-PC-11	11mm De-crimper Head (decapper) For Power Crimper
9320-PC-13	13mm De-crimper Head (decapper) For Power Crimper
9320-PC-20	20mm De-crimper Head (decapper) For Power Crimper
9320-PC-30	30mm De-crimper Head (decapper) For Power Crimper
9320-PC-32	32mm De-crimper Head (decapper) For Power Crimper

Vertical Air Crimper

Case Pack - 1 piece



9300-VAC



9300-VAC-08

Cat. No.	Description
9300-VAC	Vertical Air Crimper with Regulator and 8' Hose
9300-VAC-08	8mm Crimper Head for Vertical Air Crimper
9300-VAC-11	11mm Crimper Head for Vertical Air Crimper
9300-VAC-13	13mm Crimper Head for Vertical Air Crimper
9300-VAC-20	20mm Crimper Head for Vertical Air Crimper
930FO-VAC-13	13mm Crimper Head for Flip Off Seals (For Vertical Air Crimper)
930FO-VAC-20	20mm Crimper Head for Flip Off Seals (For Vertical Air Crimper)
9320-VAC-08	8mm De-crimper Head (decapper) for Vertical Air Crimper
9320-VAC-11	11mm De-crimper Head (decapper) for Vertical Air Crimper
9320-VAC-13	13mm De-crimper Head (decapper) for Vertical Air Crimper
9320-VAC-20	20mm De-crimper Head (decapper) for Vertical Air Crimper

Specialty Vials

Finneran Products Certified For Science™



30708-740A, 30308T-632, 30808-632

8mm Crimp Vials

Clear, crimp top borosilicate glass vials. Available with a tapered, round or flat bottom.

Shelf Pack - 100 pieces; Case Pack - 1000 pieces

Cat. No.	Description
----------	-------------

30308T-632	300µL Clear Glass Tapered Vial, Mandrel Point, 6x32mm
------------	---

30708-740A	700µL Amber Glass Tapered Vial, 7x40mm
------------	--

30808-830	800µL Clear Glass Flat Bottom Vial, 8x30mm
-----------	--



5850-08

Precision Fit Snap Top Caps™ for Conical & Tapered Glass Snap Seal™ Vials

Finneran Snap Top Caps(TM) may be snapped on and off by hand which eliminates the need for metal crimping and decapping tools.

Shelf Pack - 100 pieces; Case Pack - 1000 pieces

Cat. No.	Description
----------	-------------

5810-08	8mm Precision Fit Clear Snap Cap, 10mil PTFE
---------	--

5840-08	8mm Precision Fit Clear Snap Cap, PTFE/Butyl Rubber
---------	---

5850-08	8mm Precision Fit Clear Snap Cap, PTFE/Silicone
---------	---

5860-08	8mm Precision Fit Clear Snap Cap, PTFE/Silicone/PTFE
---------	--

5870-08	8mm Precision Fit Clear Snap Cap, PTFE/Silicone w/Slit
---------	--

8mm Aluminum Seals, Lined

Made of the highest quality aluminum. The open top allows for filling and retrieving samples with a syringe. Available with a variety of septa.

Shelf Pack - 100 pieces; Case Pack - 1000 pieces

Cat. No.	Description
----------	-------------

5110-08	8mm Silver Seal, White PTFE
---------	-----------------------------

5140-08	8mm Silver Seal, Clear PTFE/Red Rubber
---------	--

5150-08	8mm Silver Seal, PTFE/Silicone
---------	--------------------------------

5160-08	8mm Silver Seal, PTFE/Silicone/PTFE
---------	-------------------------------------

5170-08	8mm Silver Seal, PTFE/Silicone w/Slit
---------	---------------------------------------

5190-08	8mm Silver Seal, Black Viton®
---------	-------------------------------

Accessories



Crimpers/Decappers for 8mm Crimp Vials

Sold Individually

Cat. No.	Description
----------	-------------

9300-08	8mm Hand Operated Crimper
---------	---------------------------

9300-08SS	8mm Hand Operated Crimper, Stainless Steel
-----------	--

9306-08SS	8mm Hand Operated Crimper, Stainless Steel w/Grips
-----------	--

9310-08	8mm Hand Operated Decapper
---------	----------------------------

9320-08	8mm Crimp Type Decapper
---------	-------------------------

9320-08SS	8mm Hand Operated Decapper, Stainless Steel
-----------	---

9326-08SS	8mm Hand Operated Decapper, Stainless Steel w/Grips
-----------	---

Specialty Items

Finneran Products Certified For Science™

Capsule Holders



For use in dissolution vessels. Three prongs hold the capsule in place, permitting the completion of dissolution tests without capsule flotation.

Sold individually

Cat. No.	Description
91700-00	Black Capsule Holder
91700-01	Black Metallic Capsule Holder

Ampoule Holders



The Finneran Ampoule Storage Holder seals itself to your open ampule, allowing for easier sample storage, and eliminating the need to transfer the contents.

The added spring allows for easy access and removal of the ampule.

Just break off the 2mL ampule top, place the ampule in our storage holder, and attach the closure. Easily inject through the open top screw cap/stopper to remove your sample.

Made from K-Resin

Sold individually

Cat. No.	Description
9450-01	2mL Storage Ampoule Holder with Spring, Stopper and White Polypropylene Closure for Snapped Open Ampoules

Vial Racks

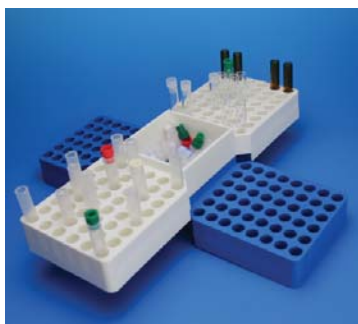

Snap Racks™

Snap Racks™ are constructed of durable glass reinforced polypropylene, with a center well to conveniently hold caps, seals, septa, etc. Racks snap together securely to double your rack capacity.

Case Pack - 5 pieces

Cat. No.	Description
9700-08	50 Position White Rack for 8mm Vials
9700-08B	50 Position Blue Rack for 8mm Vials

Multi-Use Universal Vial Rack™ System

Increased spacing allows the user to pipet samples or attach caps without removing the vials from the rack. Frame is made of glass-reinforced polypropylene and insert trays are made of transparent PETG.

Case Pack - 5 pieces

Cat. No.	Description
9600-01	Universal Vial Rack™, Blue Polypropylene, for Insert Trays
9601-08	25 Position Insert Tray for Universal Vial Rack™ for 8mm Vials



Stackable Rack



- 50 Position – 5 wells deep x 10 wells wide.
 - Use with 12x32mm vials and Tubes.
 - Stackable.
 - Alphanumeric indexing.
 - Manufactured from polypropylene.
 - Autoclavable.
 - Easy to clean.
- Standard rack colors are white, blue and black. Special colors available with a minimum order of 200 racks. Contact Finneran for more details.
- Logo screening available with a minimum purchase of 100 racks. One time screening charge. Contact Finneran for more details.

Case Pack - 5 pieces

Cat. No.	Description
9750-12B	50 Position Blue Polypropylene Stackable Rack for 12mm vials and tubes
9750-12BL	50 Position Black Polypropylene Stackable Rack for 12mm vials and tubes
9750-12W	50 Position White Polypropylene Stackable Rack for 12mm vials and tubes
LID-12	Recycled PETG Lid for Stackable Rack for 12mm Vials

96-Well Multi-Tier™ Micro Plate System (Patented)

Finneran Products Certified For Science™

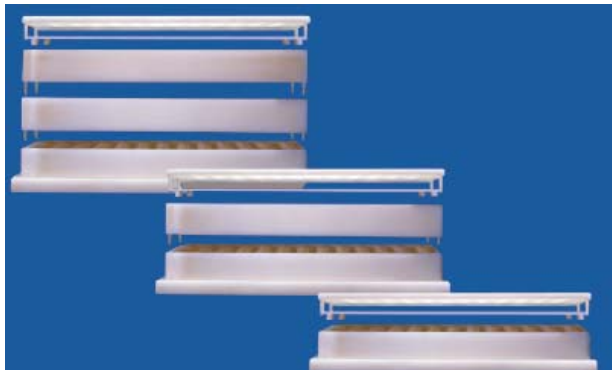

An improvement on existing 96-Well systems, the Multi-Tier™ Plate is a patented modular, reusable system featuring a base plate capable of securing 0.5mL, 1.0mL, 1.5mL, 2.0mL or 2.5mL conical glass, flat bottom and polypropylene vials. The vented design of the base plate assures uniform heating and cooling when immersed in a water bath. The cover locks the liner in place and prevents vial pullout. The prescored PTFE/Silicone/PTFE liner permits easy needle penetration, while the Molded PTFE/Silicone liner locks into each of the 96 vials and reseals after multiple injections thus reducing the chance of solvent evaporation and cross contamination.

Features/Benefits:

- Standard 8x12 (96-well) footprint with an alphanumeric grid allows use with most instruments
- Height adjustment provides volume choices of 0.5mL, 1.0mL, 1.5mL, 2.0mL and 2.5mL capacity vials
- Choice of 9mm glass or plastic vials with conical or flat bottoms
- Plate can be fixed height or adjusted to height limitation of analytical instrument
- Spacers build adjustable height to support different sized vials
- PTFE/Silicone/PTFE liner provides sample integrity
- Plate cover locks the liner in place, prevents vial pullout, and provides a secondary sealing system
- Base Plate has an open bottom to allow uniform transfer of heat or cold to vials
- Secure fit of the vials in the base plate permit use with shaker and vortex mixers during sample preparations
- Compatible with all autosampler and robotic systems
- Minimize risk of cross-contamination

Useful for:

- Experimental Assays
- Sorbent Assays
- Drug Discovery
- Drug Metabolism Research
- Combinatorial Chemistry
- High-Throughput Screening (HTS)
- Liquid Chromatography with Tandem Mass Spectrometry (LC-MS-MS)
- Metabolomic Analyses
- BioProcess Screening

Many assays require heating or cooling of the vials to simulate *in vitro* conditions or for temperature sensitive experiments. The heating or cooling is usually done with liquids or gases. The bottom design allows our base plate to be immersed in heating or cooling fluids to allow total fluid contact with the vials. This permits a uniform transfer of heat or cold to and from the vials. Our plates do not float in the bath. Constructed of chemically resistant material, select either Acrylic Butyl Styrene (ABS) or Topas (COC-Cyclic Olefin Copolymers) material.

96-Well Multi-Tier™ Micro Plate System (Patented)



Complete Plate System Includes:

1. 96-Well Base Plate
2. Choice of 5 Sizes - 0.5mL (9x17mm), 1.0mL (9x30mm), 1.5mL (9x44mm), 2.0mL (9x50mm), and 2.5mL (9x75mm) Conical or Flat Bottom Vials
3. Spacers for 1.0mL, 1.5mL, 2.0mL, and 2.5mL Plate
4. Cover
5. PTFE/Silicone/PTFE Liner



ABS Micro Plate System

Multi-Tier™ Micro Plate System (ABS)

Plates manufactured in ABS (Acrylic Butyl Styrene) have good chemical resistance against acid and bases, are heat resistant up to 80° C, and can be centrifuged to 2,500 rpms.

Cat. No.	Description	Qty
9905LC-812	0.5mL (ABS) Plate System with Glass Conical Vials	1 Plate
9910LC-812	1.0mL (ABS) Plate System with Glass Conical Vials	1 Plate
9915LC-812	1.5mL (ABS) Plate System with Glass Conical Vials	1 Plate
9920LC-812	2.0mL (ABS) Plate System with Glass Conical Vials	1 Plate
9905PLC-812	0.5mL (ABS) Plate System with Polypropylene Conical Vials	1 Plate
9910PLC-812	1.0mL (ABS) Plate System with Polypropylene Conical Vials	1 Plate
9915PLC-812	1.5mL (ABS) Plate System with Polypropylene Conical Vials	1 Plate
9920PLC-812	2.0mL (ABS) Plate System with Polypropylene Conical Vials	1 Plate
9905LC-812FB	0.5mL (ABS) Plate System with Glass Flat Bottom Vials	1 Plate
9910LC-812FB	1.0mL (ABS) Plate System with Glass Flat Bottom Vials	1 Plate
9915LC-812FB	1.5mL (ABS) Plate System with Glass Flat Bottom Vials	1 Plate
9920LC-812FB	2.0mL (ABS) Plate System with Glass Flat Bottom Vials	1 Plate
9915LC-812RB	1.5mL (ABS) Plate System with Glass Round Bottom Vials	1 Plate
9920LC-812RB	2.0mL (ABS) Plate System with Glass Round Bottom Vials	1 Plate

Multi-Tier™ Micro Plate System (Topas)

Plates manufactured in Topas (COC - Cyclic Olefin Copolymers) have excellent clarity and heat/chemical resistance. The plates can be autoclaved and sterilized, are heat resistant to 150° C, and are UV transparent down to 300nm.

Cat. No.	Description	Qty
9905LC-812T	0.5mL (Topas) Plate System with Glass Conical Vials	1 Plate
9910LC-812T	1.0mL (Topas) Plate System with Glass Conical Vials	1 Plate
9915LC-812T	1.5mL (Topas) Plate System with Glass Conical Vials	1 Plate
9920LC-812T	2.0mL (Topas) Plate System with Glass Conical Vials	1 Plate
9905PLC-812T	0.5mL (Topas) Plate System with Polypropylene Conical Vials	1 Plate
9910PLC-812T	1.0mL (Topas) Plate System with Polypropylene Conical Vials	1 Plate
9915PLC-812T	1.5mL (Topas) Plate System with Polypropylene Conical Vials	1 Plate
9920PLC-812T	2.0mL (Topas) Plate System with Polypropylene Conical Vials	1 Plate
9905LC-812FT	0.5mL (Topas) Plate System with Glass Flat Bottom Vials	1 Plate
9910LC-812FT	1.0mL (Topas) Plate System with Glass Flat Bottom Vials	1 Plate
9915LC-812FT	1.5mL (Topas) Plate System with Glass Flat Bottom Vials	1 Plate
9920LC-812FT	2.0mL (Topas) Plate System with Glass Flat Bottom Vials	1 Plate
9915LC-812RT	1.5mL (Topas) Plate System with Glass Round Bottom Vials	1 Plate
9920LC-812RT	2.0mL (Topas) Plate System with Glass Round Bottom Vials	1 Plate

**Assembled Micro Plates are available with any combination of vials and liners.
Please contact us for more information.*



Topas Micro Plate System

96-Well Multi-Tier™ Micro Plate System (Patented)

Plates also available with vials only - No Cover or Liner:

1. 96-Well Base Plate
2. Choice of 5 Sizes - 0.5mL (9x17mm), 1.0mL (9x30mm), 1.5mL (9x44mm), 2.0mL (9x50mm), and 2.5mL (9x75mm) Conical or Flat Bottom Vials
3. Spacers for 1.0mL, 1.5mL, 2.0mL, and 2.5mL Plate

Multi-Tier™ Micro Plates (ABS)

Plates manufactured in ABS (Acrylic Butyl Styrene) have good chemical resistance against acid and bases, are heat resistant up to 80° C, and can be centrifuged to 2,500 rpms.

Cat. No.	Description	Qty
9905-812	0.5mL (ABS) Plate with Glass Conical Vials only	1 Plate
9910-812	1.0mL (ABS) Plate with Glass Conical Vials only	1 Plate
9915-812	1.5mL (ABS) Plate with Glass Conical Vials only	1 Plate
9920-812	2.0mL (ABS) Plate with Glass Conical Vials only	1 Plate
9905P-812	0.5mL (ABS) Plate with Polypropylene Conical Vials only	1 Plate
9910P-812	1.0mL (ABS) Plate with Polypropylene Conical Vials only	1 Plate
9915P-812	1.5mL (ABS) Plate with Polypropylene Conical Vials only	1 Plate
9920P-812	2.0mL (ABS) Plate with Polypropylene Conical Vials only	1 Plate
9905-812FB	0.5mL (ABS) Plate with Glass Flat Bottom Vials only	1 Plate
9910-812FB	1.0mL (ABS) Plate with Glass Flat Bottom Vials only	1 Plate
9915-812FB	1.5mL (ABS) Plate with Glass Flat Bottom Vials only	1 Plate
9920-812FB	2.0mL (ABS) Plate with Glass Flat Bottom Vials only	1 Plate
9915-812RB	1.5mL (ABS) Plate with Glass Round Bottom Vials only	1 Plate
9920-812RB	2.0mL (ABS) Plate with Glass Round Bottom Vials only	1 Plate



Multi-Tier™ Micro Plate System (Topas)

Plates manufactured in Topas (COC - Cyclic Olefin Copolymers) have excellent clarity and heat/chemical resistance. The plates can be autoclaved and sterilized, are heat resistant to 150° C, and are UV transparent down to 300nm.

Cat. No.	Description	Qty
9905-812T	0.5mL (Topas) Plate with Glass Conical Vials only	1 Plate
9910-812T	1.0mL (Topas) Plate with Glass Conical Vials only	1 Plate
9915-812T	1.5mL (Topas) Plate with Glass Conical Vials only	1 Plate
9920-812T	2.0mL (Topas) Plate with Glass Conical Vials only	1 Plate
9905P-812T	0.5mL (Topas) Plate with Polypropylene Conical Vials only	1 Plate
9910P-812T	1.0mL (Topas) Plate with Polypropylene Conical Vials only	1 Plate
9915P-812T	1.5mL (Topas) Plate with Polypropylene Conical Vials only	1 Plate
9920P-812T	2.0mL (Topas) Plate with Polypropylene Conical Vials only	1 Plate
9905-812FBT	0.5mL (Topas) Plate with Glass Flat Bottom Vials only	1 Plate
9910-812FBT	1.0mL (Topas) Plate with Glass Flat Bottom Vials only	1 Plate
9915-812FBT	1.5mL (Topas) Plate with Glass Flat Bottom Vials only	1 Plate
9920-812FBT	2.0mL (Topas) Plate with Glass Flat Bottom Vials only	1 Plate
9915-812RBT	1.5mL (Topas) Plate with Glass Round Bottom Vials only	1 Plate
9920-812RT	2.0mL (Topas) Plate with Glass Round Bottom Vials only	1 Plate



**Assembled Micro Plates are available with any combination of vials and liners.
Please contact us for more information.*

96-Well Multi-Tier™ Micro Plate System (Patented)

Replacement Accessories for 96-Well Multi-Tier™ Micro Plate System



Solid Clear Cover



24- and 48-Well
Machine-Made Base Plates



Glass Conical Vials

Assemble your own 96-Well Multi-Tier™ Micro Plate System:

0.5mL Plate System	Requires Base Plate Only
1.0mL Plate System	Requires one Spacer and Base Plate
1.5mL Plate System	Requires two Spacers and Base Plate
2.0mL Plate System	Requires three Spacers and Base Plate
2.5mL Plate System	Requires four Spacers and Base Plate

Cat. No.	Description	Qty
9900C-812	Cover for Plate System - ABS material	5 Pieces
9900C-812T	Cover for Plate System - Topas material	5 Pieces
9900-812	Spacer for Plate System - ABS material	1 Piece
9900-812T	Spacer for Plate System - Topas material	1 Piece
9996-812	96-Well Base Plate - ABS material	1 Piece
9996-812GFP	96-Well Base Plate - Glass-filled Polypropylene material	1 Piece
9996-812T	96-Well Base Plate - Topas material	1 Piece
9900VFC-812	Solid Clear Cover for Plate System	5 Pieces

Machine-Made Base Plates

Cat. No.	Description	Qty
9924-670	24-Well Flat Bottom Base Plate - ABS material	1 Plate
9948-812	48-Well Base Plate - ABS material	1 Plate

Replacement Vials for 96-Well Multi-Tier™ Micro Plate System

- Glass vials are manufactured of Type I borosilicate glass
- Glass and polypropylene vials fit securely in the 96-well Base Plate
- All glass vials are available silanized

Glass Conical Vials

Cat. No.	Description	Qty
4050-917	0.5mL Clear Glass Conical Vials, 9x17mm	
4050-917A	0.5mL Amber Glass Conical Vials, 9x17mm	100
4100-930	1.0mL Clear Glass Conical Vials, 9x30mm	100
4100-930A	1.0mL Amber Glass Conical Vials, 9x30mm	100
4150-944	1.5mL Clear Glass Conical Vials, 9x44mm	100
4150-944A	1.5mL Amber Glass Conical Vials, 9x44mm	100
4200-950	2.0mL Clear Glass Conical Vials, 9x50mm	100
4200-950A	2.0mL Amber Glass Conical Vials, 9x50mm	100

96-Well Multi-Tier™ Micro Plate System (Patented)



Glass Flat Bottom Vials



Polypropylene Conical Vials



Vial Loader is fast and convenient for loading vials into the Base Plate

To use the Vial Loader:

1. Peel away the packaging and place an empty Base Plate on top of the vial loader.
2. Invert the entire unit and the plate is ready to use.

Replacement Vials for 96-Well Multi-Tier™ Micro Plate System

Glass Flat Bottom Vials

Cat. No.	Description	Qty
4050FB-917	0.5mL Clear Glass Flat Bottom Vials, 9x17mm	100
4050FB-917A	0.5mL Amber Glass Flat Bottom Vials, 9x17mm	100
4100FB-930	1.0mL Clear Glass Flat Bottom Vials, 9x30mm	100
4100FB-930A	1.0mL Amber Glass Flat Bottom Vials, 9x30mm	100
4150FB-944	1.5mL Clear Glass Flat Bottom Vials, 9x44mm	100
4150FB-944A	1.5mL Amber Glass Flat Bottom Vials, 9x44mm	100
4200FB-950	2.0mL Clear Glass Flat Bottom Vials, 9x50mm	100
4200FB-950A	2.0mL Amber Glass Flat Bottom Vials, 9x50mm	100
4250FB-975	2.5mL Clear Glass Flat Bottom Vials, 9x75mm	100

Glass Round Bottom Vials

Cat. No.	Description	Qty
4200RB-950	2.0mL Clear Glass Round Bottom Vials, 9x50mm	100

Polypropylene Conical and Flat Bottom Vials

Cat. No.	Description	Qty
4050P-917	0.5mL Polypropylene Conical Vials, 9x17mm	100
4100P-930	1.0mL Polypropylene Conical Vials, 9x30mm	100
4150P-944	1.5mL Polypropylene Conical Vials, 9x44mm	100
4200P-950	2.0mL Polypropylene Conical Vials, 9x50mm	100
4200FP-950	2.0mL Polypropylene Flat Bottom Vials, 9x50mm	100

Glass Conical Vials in Vial Loader

Cat. No.	Description	Qty
4050-917VL	0.5mL Clear Glass Conical Vials in Vial Loader, 9x17mm	96
4050-917AVL	0.5mL Amber Glass Conical Vials in Vial Loader, 9x17mm	96
4100-930VL	1.0mL Clear Glass Conical Vials in Vial Loader, 9x30mm	96
4100-930AVL	1.0mL Amber Glass Conical Vials in Vial Loader, 9x30mm	96
4150-944VL	1.5mL Clear Glass Conical Vials in Vial Loader, 9x44mm	96
4150-944AVL	1.5mL Amber Glass Conical Vials in Vial Loader, 9x44mm	96
4200-950VL	2.0mL Clear Glass Conical Vials in Vial Loader, 9x50mm	96
4200-950AVL	2.0mL Amber Glass Conical Vials in Vial Loader, 9x50mm	96

Glass Flat Bottom Vials in Vial Loader

Cat. No.	Description	Qty
4050FB-917VL	0.5mL Clear Glass Flat Bottom Vials in Vial Loader, 9x17mm	96
405FB-917AVL	0.5mL Amber Glass Flat Bottom Vials in Vial Loader, 9x17mm	96
4100FB-930VL	1.0mL Clear Glass Flat Bottom Vials in Vial Loader, 9x30mm	96
410FB-930AVL	1.0mL Amber Glass Flat Bottom Vials in Vial Loader, 9x30mm	96
4150FB-944VL	1.5mL Clear Glass Flat Bottom Vials in Vial Loader, 9x44mm	96
415FB-944AVL	1.5mL Amber Glass Flat Bottom Vials in Vial Loader, 9x44mm	96
4200FB-950VL	2.0mL Clear Glass Flat Bottom Vials in Vial Loader, 9x50mm	96
420FB-950AVL	2.0mL Amber Glass Flat Bottom Vials in Vial Loader, 9x50mm	96

Glass Round Bottom Vials in Vial Loader

Cat. No.	Description	Qty
4200RB-950VL	2.0mL Clear Glass Round Bottom Vials in Vial Loader, 9x50mm	96

96-Well Multi-Tier™ Micro Plate System (Patented)

Replacement Vials for 96-Well Multi-Tier™ Micro Plate System

Polypropylene Conical and Flat Bottom Vials in Vial Loader

Cat. No.	Description	Qty
4050P-917VL	0.5mL Polypropylene Conical Vials in Vial Loader, 9x17mm	96
4100P-930VL	1.0mL Polypropylene Conical Vials in Vial Loader, 9x30mm	96
4150P-944VL	1.5mL Polypropylene Conical Vials in Vial Loader, 9x44mm	96
4200P-950VL	2.0mL Polypropylene Conical Vials in Vial Loader, 9x50mm	96
4200FP-950VL	2.0mL Polypropylene Flat Bottom Vials in Vial Loader, 9x50mm	96

Vial Remover Tool



- Use tool to easily remove 9mm vials from the 96-well base plate

Cat. No.	Description	Qty
4000-VR	Vial Remover Tool	1

Sealing Systems for 96-Well Multi-Tier™ Micro Plate

- The Liners designed specifically for the 96-Well Multi-Tier Micro Plate preserves sample integrity and prevents cross contamination
- Our sealing systems prevent evaporative losses and contamination from ambient air
- The PTFE faced medical grade silicone mats meet U.S.P. Class VI requirements

Prescored Recessed Well Flat Liner with Cross Slits

- Cross slits permit easier needle penetration
- Liner locks into the plate to prevent vial pull out

Cat. No.	Description	Qty
996070RW-812	Prescored Recessed Well PTFE/Silicone/PTFE Flat Liner	5

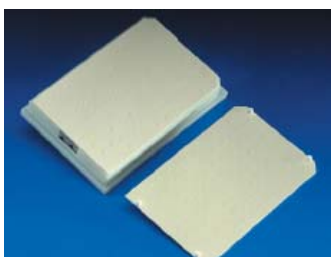

PTFE/Silicone/PTFE Flat Liner

Molded 96 Plug Mat

- Mat locks into the 9mm vials to create an inert sample environment

Cat. No.	Description	Qty
996015-812	Molded Silicone Mat, 96 Plugs	5
996035-812	Prescored Molded Silicone Mat, 96 Plugs	5
996050-812	Molded PTFE/Silicone Mat, 96 Plugs	5
996075-812	Prescored Molded PTFE/Silicone Mat, 96 Plugs	5

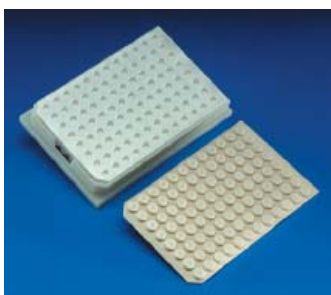

Molded Mat -96 plugs seal individual vials to isolate samples

Molded PTFE/Silicone Strips and Individual Plugs

Cat. No.	Description	Qty
96050-8STRIP	Molded PTFE/Silicone Strip, 8 Plugs	12
96075-8STRIP	Prescored Molded PTFE/Silicone Strip, 8 Plugs	12
9605-12STRIP	Molded PTFE/Silicone Strip, 12 Plugs	8
9607-12STRIP	Prescored Molded PTFE/Silicone Strip, 12 Plugs	8
96050-8PLUG	Molded PTFE/Silicone Plug, Single Plug	100
96075-8PLUG	Prescored Molded PTFE/Silicone Plug, Single Plug	100



Molded 8-plug strips and individual plugs allow limited sample testing

96-Well Multi-Tier™ Micro Plate System (Patented)

Sealing Systems for 96-Well Multi-Tier™ Micro Plate

Push Cap Mat for 9mm Vials in 96-well Multi-Tier Plates

- *Material: Thermoplastic Elastomer (TPE)*
- *A single push of the mat simultaneously closes 96 individual vials*
- *Storage temperature down to -80° C*
- *Certified free of DNA, RNA, Dnase, Rnase, endotoxins/pyrogenics*
- *Packaging - 10 mats per pack*



Cat. No.	Description	Qty
96PCM-W	Push Cap Mat - White	10
96PCM-BL	Push Cap Mat - Black	10
96PCM-B	Push Cap Mat - Blue	10
96PCM-R	Push Cap Mat - Red	10
96PCM-G	Push Cap Mat - Green	10
96PCM-Y	Push Cap Mat - Yellow	10
96PCM-O	Push Cap Mat - Orange	10

Aluminum 96-Well Micro Plate System (Patented)

Finneran Products Certified For Science™



The Solid Aluminum Base Plate and the Vented Aluminum Base Plate are ideal for use with volatile solvents or for situations requiring uniform heating and cooling of samples.

- Standard 8x12 (96 well) footprint with a stamped alpha-numeric ID grid
- Base plate design assures uniform heating and cooling of samples
- Immersion of vented base plate in liquids allows total fluid contact with the vials.
- Use of aluminum promotes more efficient heat transfer
- Reusable anodized aluminum metal plate prevents finger print smudges and discoloration to provide years of use
- Ideal for freeze drying samples, volatile solvents, salt screening, High-throughput Solubility, and Physical Characterization
- Secure vial fit prevents cross-talk and contamination
- Choice of glass conical and flat bottom vials in 5 sizes: 0.5mL, 1.0mL, 1.5mL, 2.0mL and 2.5mL
- Choose a sealing method from the variety of molded mats and sealing films



Vented Base Plate System

Solid Aluminum Base Plate System*

Cat. No.	Description	Qty
9996-812AST	Solid Aluminum, 96-Well Base Plate w/Tapped Corner Holes	1 Plate
9996-812AT	Vented Aluminum, 96-Well Base Plate w/Tapped Corner Holes	1 Plate
9900AC-812	Aluminum Cover for Base Plate	1 Piece
SCREW-500mL	Stainless Steel Screws for 0.5mL Aluminum 96-Well Base Plate	4 Pieces
SCREW-1.0mL	Stainless Steel Screws for 1.0mL Aluminum 96-Well Base Plate	4 Pieces
SCREW-1.5mL	Stainless Steel Screws for 1.5mL Aluminum 96-Well Base Plate	4 Pieces
SCREW-2.0mL	Stainless Steel Screws for 2.0mL Aluminum 96-Well Base Plate	4 Pieces
SCREW-2.5mL	Stainless Steel Screws for 2.5mL Aluminum 96-Well Base Plate	4 Pieces

* Assembled Solid Aluminum Base Plate Systems are available - please contact us for more information.

Glass Vials for Aluminum 96-Well Micro Plate System

- 9mm Glass vials are manufactured of Type I Borosilicate glass
- All Glass Vials are available Silanized



Glass Vials for Plate System

Cat. No.	Description	Qty
4050-917	0.5mL Glass Conical Vials, 9x17mm	100
4100-930	1.0mL Glass Conical Vials, 9x30mm	100
4150-944	1.5mL Glass Conical Vials, 9x44mm	100
4200-950	2.0mL Glass Conical Vials, 9x50mm	100
4050FB-917	0.5mL Glass Flat Bottom Vials, 9x17mm	100
4100FB-930	1.0mL Glass Flat Bottom Vials, 9x30mm	100
4150FB-944	1.5mL Glass Flat Bottom Vials, 9x44mm	100
4200FB-950	2.0mL Glass Flat Bottom Vials, 9x50mm	100
4250FB-975	2.5mL Glass Flat Bottom Vials, 9x75mm	100

Aluminum 96-Well Micro Plate System (Patented)



Vial loader is fast and convenient for loading vials into the base plate

To use the Vial Loader:

1. Peel away the packaging and place an empty Base Plate on top of the vial loader.
2. Invert the entire unit and the plate is ready to use.



Vial Remover Tool



Molded mats and strips seal individual vials to isolate samples



Molded individual plugs allow limited sample testing

Vial Loader for Aluminum 96-Well Micro Plate System

Cat. No.	Description	Qty
4050-917VL	0.5mL Glass Conical Vials in Vial Loader, 9x17mm	96
4100-930VL	1.0mL Glass Conical Vials in Vial Loader, 9x30mm	96
4150-944VL	1.5mL Glass Conical Vials in Vial Loader, 9x44mm	96
4200-950VL	2.0mL Glass Conical Vials in Vial Loader, 9x50mm	96
4050FB-917VL	0.5mL Glass Flat Bottom Vials in Vial Loader, 9x17mm	96
4100FB-930VL	1.0mL Glass Flat Bottom Vials in Vial Loader, 9x30mm	96
4150FB-944VL	1.5mL Glass Flat Bottom Vials in Vial Loader, 9x44mm	96
4200FB-950VL	2.0mL Glass Flat Bottom Vials in Vial Loader, 9x50mm	96
4000-VR*	Vial Remover Tool	1

* Use tool to easily remove 9mm vials from the 96-well base plate

Sealing Systems for 96-Well Multi-Tier™ Micro Plate

- The Liners designed specifically for the 96-Well Multi-Tier™ Micro Plate preserves sample integrity and prevents cross contamination
- Our sealing systems prevent evaporative losses and contamination from ambient air
- The PTFE faced medical grade silicone mats meet U.S.P. Class VI requirements

Molded 96-Plug Mat

- Mat locks into the 9mm vials to create an inert sample environment

Cat. No.	Description	Qty
996015-812	Molded Silicone Mat, 96 Plugs	5
996035-812	Prescored Molded Silicone Mat, 96 Plugs	5
996050-812	Molded PTFE/Silicone Mat, 96 Plugs	5
996075-812	Prescored Molded PTFE/Silicone Mat, 96 Plugs	5

Molded PTFE/Silicone Strips and Individual Plugs

Cat. No.	Description	Qty
96050-8STRIP	Molded PTFE/Silicone Strip, 8 Plugs	12
96075-8STRIP	Prescored Molded PTFE/Silicone Strip, 8 Plugs	12
9605-12STRIP	Molded PTFE/Silicone Strip, 12 Plugs	8
9607-12STRIP	Prescored Molded PTFE/Silicone Strip, 12 Plugs	8
96050-8PLUG	Molded PTFE/Silicone Plug, Single Plug	100
96075-8PLUG	Prescored Molded PTFE/Silicone Plug, Single Plug	100

Snap Seal™ Vials and Snap Top Caps™ for 96-Well Multi-Tier™ Micro Plate System

Finneran Products Certified For Science™

- Designed to fit the 96-Well Multi-Tier Micro Plate System providing maximum flexibility
- Choice of glass conical, tapered, and flat bottom vials in four sizes: 0.5mL, 0.75mL, 1.0mL, and 2.0mL
- Glass vials provide an inert solvent resistant environment for samples
- Conical and tapered design of the vials allows sample access down to 10µL
- Compatible with all autosamplers and robotic systems
- All glass vials are available Silanized



Use 8mm Precision Fit Snap Cap to seal individual vials



9mm OD vials fit securely in the Multi-Tier Micro Plate Base



Use 8mm Precision Fit Snap Cap to seal individual vials



Topas Base Plate and Spacer

Glass Snap Seal™ Vials, 8mm Crimp Finish

Cat. No.	Description	Qty
30508-922	0.5mL Glass Conical Snap Seal™ Vial, 9 x 22mm, 8mm Crimp	100
30508FB-922	0.5mL Glass Flat Bottom Snap Seal™ Vial, 9 x 22mm, 8mm Crimp Finish	100
307508-936	0.75mL Glass Conical Snap Seal™ Vial, 9 x 36mm, 8mm Crimp	100
307508T-936	0.75mL Glass Tapered Snap Seal™ Vial, 9 x 36mm, 8mm Crimp	100
31008-946	1.0mL Glass Conical Snap Seal™ Vial, 9 x 46mm, 8mm Crimp	100
31008FB-946	1.0mL Glass Flat Bottom Snap Seal™ Vial, 9 x 46mm, 8mm Crimp Finish	100
31008T-946	1.0mL Glass Tapered Snap Seal™ Vial, 9 x 46mm, 8mm Crimp	100
32008FB-950	2.0mL Glass Flat Bottom Snap Seal™ Vial, 9x50mm, 8mm Crimp Finish	100

Precision Fit Snap Top Caps™ for Conical and Tapered Glass Snap Seal™ Vials, 8mm Crimp Finish

Cat. No.	Description	Qty
5810-08	8mm Precision Fit Clear Snap Cap, 10mil PTFE	100
5840-08	8mm Precision Fit Clear Snap Cap, PTFE/Butyl Rubber	100
5850-08	8mm Precision Fit Clear Snap Cap, PTFE/Silicone	100
5860-08	8mm Precision Fit Clear Snap Cap, PTFE/Silicone/PTFE	100
5870-08	8mm Precision Fit Clear Snap Cap, PTFE/Silicone w/Slit	100

96-Well Multi-Tier™ Micro Plate System - Base Plate and Spacers

Assemble your own 96-Well Multi-Tier™ Micro Plate System:

0.5mL System	Requires Base Plate Only
0.75mL System	Requires one Spacer and Base Plate
1.0mL System	Requires two Spacers and Base Plate
2.0mL System	Requires three Spacers and Base Plate

ABS Base Plate - ABS (Acrylic Butyl Styrene) has good chemical resistance against acid and bases, are heat resistant up to 80°C, and can be centrifuged to 2,500 rpms.

Topas Base Plate - Topas (COC - Cyclic Olefin Copolymers) have excellent clarity and heat/chemical resistance. Plates can be autoclaved and sterilized, are heat resistant to 150°C, and are UV transparent down to 300nm.

Cat. No.	Description	Qty
9900-812	Spacer for Plate System - ABS material	1 Piece
9900-812T	Spacer for Plate System - Topas material	1 Piece
9996-812	96-Well Base Plate - ABS material	1 Piece
9996-812T	96-Well Base Plate - Topas material	1 Piece

Snap Seal™ Vials and Snap Top Caps™ for 96-Square Deep Well Microplates

Finneran Products Certified For Science™



Conical vials are manufactured of Type I Borosilicate Glass



8mm OD vials fit securely in 96-square deep well plates like Greiner, Matrix and Ritter



Use 8mm Precision Fit Snap Cap to seal individual vials

- Designed to fit 96-Square Deep Well Microplates
- Choice of glass conical and tapered vials in 3 sizes: 400µL, 750µL, and 800µL
- Glass vials provide an inert solvent resistant environment for samples
- Conical and tapered design of the vials allows sample access down to 10µL
- Compatible with autosamplers and robotic systems
- All Glass Vials are available Silanized

Glass Snap Seal™ Vials, 8mm Snap Seal™ & Crimp Finish

Cat. No.	Description	Qty
9920-96PP	96-Square Deep Well Polypropylene Plate	1
30408-822*	400µL Glass Conical Snap Seal™ Vial, 8x22mm, 8mm Snap Seal™ Finish	100
307508-836	750µL Glass Conical Snap Seal™ Vial, 8x36mm, 8mm Snap Seal™ Finish	100
30808T-846	800µL Glass Tapered Snap Seal™ Vial, 8x46mm, 8mm Snap Seal™ Finish	100
30808CT-846	800µL Glass Tapered Crimp Vial, 8x46mm, 8mm Crimp Finish	100
3088CT-846VL	800µL Glass Tapered Crimp Vial, 8x46mm, 8mm Crimp Finish in Vial Loader	96
31008RB-846	800µL Glass Round Bottom Snap Seal™ Vial, 8x46mm, 8mm Snap Seal™ Finish	100
3108RB-846VL	800µL Glass Round Bottom Snap Seal™ Vial, 8x46mm, 8mm Snap Seal™ Finish in Vial Loader	96

* 400µL conical vial must be capped prior to placement in the 96-well microplate

Precision Fit Snap Top Caps™ for Glass Snap Seal™ Vials, 8mm Snap Seal™ Finish

Cat. No.	Description	Qty
5810-08	8mm Precision Fit Clear Snap Cap, 10mil PTFE	100
5840-08	8mm Precision Fit Clear Snap Cap, PTFE/Butyl Rubber	100
5850-08	8mm Precision Fit Clear Snap Cap, PTFE/Silicone	100
5860-08	8mm Precision Fit Clear Snap Cap, PTFE/Silicone/PTFE	100
5870-08	8mm Precision Fit Clear Snap Cap, PTFE/Silicone w/Slit	100

Glass Inserts and Molded Mats for Standard 96-Square Deep Well Microplates

Finneran Products Certified For Science™



System uses 96 glass tapered inserts in a 96-square deep well plate.

An ideal solution for sample storage, reactive chemistry and biological testing.

- Polypropylene plate, glass inserts, and molded mats can be autoclaved and sterilized.
- Plates have a standard 8x12 foot-print with etched 1-12 by A-H grid.
- Snug fit of glass inserts allows use with shakers and vortex mixers.

96-Well Polypropylene Plate and Glass Inserts

- Push point insert tip design allows sample access down to 10 μ L
- Glass vials provide an inert solvent resistant environment for samples
- Assembled plate has excellent thermal stability and chemical resistance
- 700 μ L inserts assembled in the square well plate can be sealed with a Molded 96-Square Well Mat
- 1.0mL inserts assembled in the square well plate can be sealed with a Molded 96-Round Well Mat
- Compatible with autosamplers and robotic systems
- All Glass Inserts are available Silanized

Cat. No.	Description	Qty
9920-96PP	96-Square Deep Well Polypropylene Plate	1
4070-837	700 μ L Glass Tapered Insert, 8x37mm	100
4070-837A	700 μ L Amber Glass Tapered Insert, 8x37mm	100
4070-837VL	700 μ L Glass Tapered Insert, 8x37mm, in Vial Loader	96
4070FT-837	700 μ L Glass Flat Tip Tapered Insert, 8x37mm	100
4070FPT-837	700 μ L Glass Flat Pulled Tapered Insert, 8x37mm	100
407FPT-837VL	700 μ L Glass Flat Pulled Tapered Insert, 8x37mm, in Vial Loader	96
405-845	1.0mL Glass Conical Tapered Insert, 8x45mm	100
405-845A	1.0mL Amber Glass Conical Tapered Insert, 8x45mm	100
405-845VL	1.0mL Glass Conical Tapered Insert, 8x45mm, in Vial Loader	96
405FT-845	1.0mL Glass Flat Tip Tapered Insert, 8x45mm	100
405FT-845VL	1.0mL Glass Flat Tip Tapered Insert, 8x45mm, in Vial Loader	96
9907-812PP	96-Square Deep Well Plate Assembled with 700 μ L Tapered Insert	1
9910-812PP	96-Square Deep Well Plate Assembled with 1.0mL Tapered Insert	1
9910FT-812PP	96-Square Well Plate Assembled w/1.0mL Tapered Flat Tip Insert	1

Glass Inserts and Molded Mats for Standard 96-Square Deep Well Microplate



Square Well Molded Mat

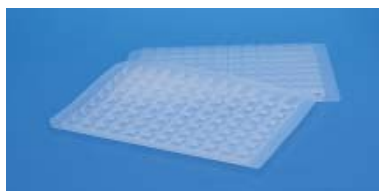

976050SW-96



Round Well Molded Mat

Molded Mats for 700µL Inserts Assembled in 96-Square Deep Well Plate

- Manufactured from medical grade silicone
- Autoclavable and excellent chemical compatibility

Cat. No.	Description	Qty
996050SW-96	96-Square Well - Gray Molded PTFE/Silicone Mat	5
996075SW-96	96-Square Well - Prescored Gray Molded PTFE/Silicone Mat	5
997005SW-96	96-Square Well - Green Molded Silicone only Mat	5
997075SW-96	96-Square Well - Prescored Green Molded Silicone only Mat	5
976050SW-96	96-Square Clear Sealing Mat with Spray Coated PTFE/Premium Silicone	5
976075SW-96	96-Square Pre-Slit Clear Sealing Mat with Spray Coated PTFE/Premium Silicone	5
976250SW-96	96-Square Ultra Low Bleed Clear Sealing Mat with Spray Coated PTFE/Premium Silicone	5
976275SW-96	96-Square Pre-Slit Ultra Low Bleed Clear Sealing Mat with Spray Coated PTFE/Premium Silicone	5

Molded Mats for 1.0mL Inserts Assembled in 96-Square Deep Well Plate

- Round liner plug locks into 8mm glass inserts assembled in the 96-Square Deep Well Plate
- Manufactured from medical grade silicone
- Autoclavable and excellent chemical compatibility

Cat. No.	Description	Qty
986050VP-812	96-Round Well - Blue Molded PTFE/Silicone Mat	5
986075VP-812	96-Round Well - Prescored Blue Molded PTFE/Silicone Mat	5
987050VP-812	96-Round Well - Blue Molded Silicone only Mat	5
987075VP-812	96-Round Well - Prescored Blue Molded Silicone only Mat	5

96-Well Plate with Glass Inserts Designed for High Throughput Chromatography

Finneran Products Certified For Science™

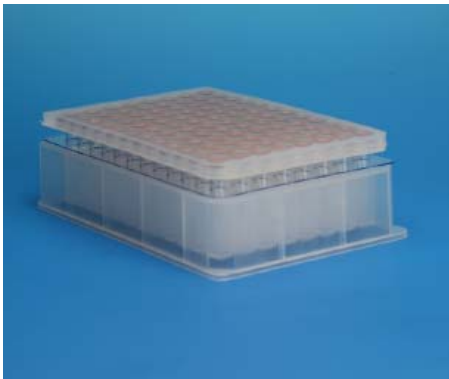

Glass inserts loaded in the 96-well plate performs similar to standard 12x32mm vials for Chromatography testing. 96-well pierceable Cap Mat is lined with the same PTFE/Silicone septa used in closures for Chromatography.

- Glass inserts provide an inert solvent resistant environment for samples.
- Assembled plate has excellent thermal stability.
- Pierceable Cap Mat is designed to seal crimp top or flanged inserts, ensuring sample integrity.
- Cap Mat assembles easily with the inserts in the plate - no need for machines to seal the plate.
- Compatible with autosamplers and robotic systems.

96-Well Polypropylene Plate and Glass Inserts

Cat. No.	Description	Qty
4035FT-632	350µL Glass Conical Pulled Point Insert with Flange, 6x32mm	100
4035FT-632VL	350µL Glass Conical Pulled Point Insert with Flange, 6x32mm, in Vial Loader	96
786201	96-Well Polypropylene MasterBlock® Plate, 600µL, V Shape Bottom	1 Plate
99035-812PP	96-Well Polypropylene Plate Assembled with 350µL Glass Conical Pulled Point Inserts with Flange	1 Plate



4035FT-632VL
350µL Glass Conical Pulled Point Insert with Flange, 6x32mm, in Vial Loader

Pierceable Cap Mat PTFE/Silicone Lined

Cat. No.	Description	Qty
96050FW-812	96-Well Pierceable Cap Mat, Clear PTFE/Orange Silicone Lined, for Crimp Top or Flanged Inserts in MicroPlates	1
96075FW-812	96-Well Pierceable Cap Mat, Clear PTFE/Orange Silicone Lined with Slit, for Crimp Top or Flanged Inserts in MicroPlates	1

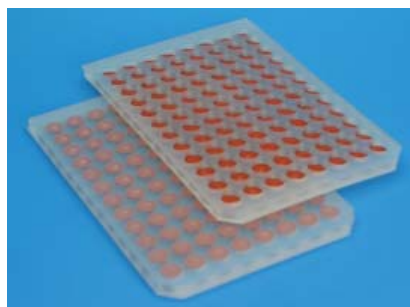

96050FW-812

Sealing Films for 96-Well Microplates

Finneran Products Certified For Science™

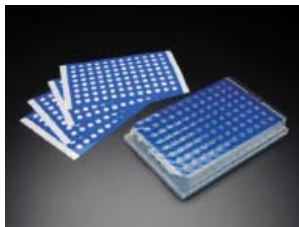

PTFE sealing film has an adhesive free area around each well so plastic pipette tips and metal probes stay clean.

96-Well Pattern Blue PTFE Sealing Film (Patented)

- Solvent-free adhesives adheres to polypropylene, polystyrene and polycarbonate materials
- PTFE film is compatible with aqueous solutions and organic solvents
- Excellent chemical resistance, resistant to DMSO
- Works in Autosamplers with no coring of material and no clogging of needles
- Prevents cross-contamination and evaporation
- Adhesive is resistant to leaching and breakdown
- Functional temperatures range -80°C to +120°C

Cat. No.	Description	Qty
BST-9790	2mil Blue PTFE 96-Well Pattern Film	100



The adhesive-free zone above each well prevents adhesive fouling of the pipet tip or probe, ultimately minimizing the amount of adhesive that comes into contact with the sample.

96-Well Adhesive Free Zone Sealing Film (Patent Pending)

With a 70µm top layer and inert white polypropylene and acrylic adhesive sublayer, this easy-piercing sealing film allows direct sample recovery with single or multichannel pipettors and robotic probes.

- Dimensions are 79.4mm x 142.9mm for 96-well plates
- Clear zones and end tabs facilitate well alignment and accurate positioning
- Inert, chemical resistant
- Functional temperature range -40°C to +90°C

Cat. No.	Description	Qty
ZAF-PE-50	Adhesive Free Zone Sealing Film	50

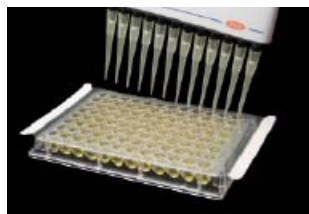

EZ-Pierce™ Sealing Films

EZ-Pierce™ Sealing Films

Easily pierceable, 70µm thick, polyethylene with acrylic adhesive, EZ-Pierce™ sealing films allow direct sample recovery with single or multichannel pipettors and robotic probes.

- Dimensions are 82.6mm x 142.9mm for 96-well plates
- Easily pierceable with pipet tips or robotic probes
- Inert, chemical resistant
- Functional temperature range -40°C to +90°C

Cat. No.	Description	Qty
EZP-NL-100	EZ-Pierce Sealing Film	100

Sealing Films for 96-Well Microplates

AlumaSeal 96™ Sealing Films



A 38 µm thick aluminum foil sealing film for use with 96-well plates. Fits inside the rim of raised-rim plates.

AlumaSeal 96™ sealing films have one partial-width end tab with no perforations.

- Fits inside rim of raised-rim plate
- Heat & cold resistant, recommended for temperatures from -40°C to +150°C
- Easily pierceable
- Certified DNase-, RNase-, and nucleic-acid-free
- Dimensions: 127mm x 78mm (including single 9.5mm end tab)

Cat. No.	Description	Qty
F-96-100	AlumaSeal 96 Sealing Films	100
PDL-5	Film-Sealing Paddles*	5

* Completing application of AlumaSeal 96 sealing films by pressing with an accessory film-sealing paddles assures a secure uniform seal around all wells. The paddle fits within the rim of a raised-well plate.

AbsorbMax™ Sealing Films for Fluorescence and Photoprotection

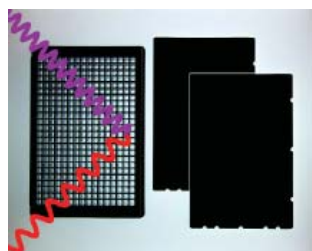

AbsorbMax™ Black Sealing Films

AbsorbMax™ sealing films are 203µm thick black vinyl films with 37µm acrylic adhesive for use with 96-well, 384-well, and 1536-well black microplates. The sealing films may be applied to either the top or bottom of the plate. A split backing aids in applying the sealing film properly. Edge cutouts assist in positioning and accommodate ribs on the plate bottom. The light-blocking and absorbing properties of AbsorbMax™ sealing films make them ideal for protecting light-sensitive samples during storage. In fluorescence applications they reduce stray light and well-to-well crosstalk. For top-reading fluorescence applications, apply the black sealing film to the plate bottom with clear-bottom wells. For bottom-reading fluorescence, use the black sealing film as a top seal. AbsorbMax™ sealing films will fit within the rim of raised-rim plates.

- Black light-absorbing sealing films for use with black microplates
- May be applied to top or bottom of plate
- Protect light-sensitive samples during storage
- Reduce stray light and crosstalk in fluorescence assays
- Dimensions: 76.2mm x 114.3mm
- Recommended temperature range: -40°C to +80°C

Cat. No.	Description	Qty
BK-50	AbsorbMax™ Black Sealing Films for Luminescence Assays, Vinyl, 203µm Thick, Opaque, Non-Sterile	50

BrightMax™ Sealing Films for Luminescence and Microscopy

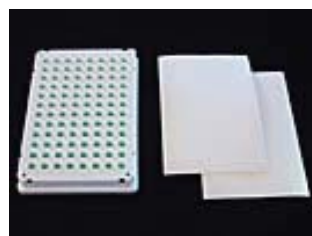

BrightMax™ White Sealing Films

BrightMax™ sealing films are 203µm thick white vinyl films with 37µm acrylic adhesive for use with white microplates. The sealing films may be applied to either the top or bottom of the plate. A split backing aids in applying the sealing film properly. The light-reflective properties of BrightMax™ plate-sealing films on clear-bottom plates maximize sensitivity of bioluminescence and chemiluminescence assays in bottom-reading luminometers. White films also have application as a backing matrix for microscopy of punchout samples from filter plates, for example in ELISPOT assays. A backing split singly on the long dimension aids in applying film to plates.

- White light-reflecting sealing films for use with white microplates
- May be applied to top or bottom of plate
- Maximize intensity and signal-to-noise ratios in luminescence assays
- Additional applications for mounting and storage of filters for microscopy, for example in ELISPOT assays
- Dimensions: 76.2mm x 116mm with no end tabs
- Recommended temperature range: -40°C to +80°C

Cat. No.	Description	Qty
WT-50	BrightMax™ White Sealing Films for Fluorescence, Luminescence Photoprotection, Vinyl, 203µm Thick, Opaque, Non-Sterile	50

Sealing Films for 96-Well Microplates



X-Pierce™ Sealing Films

X-Pierce™ Precut Pierceable Sealing Films for Automation

Also useful for protecting contents of plate from contamination during multiple manual reagent additions over time. X-Pierce™ sealing films are 89µm thick vinyl with a 18µm thick adhesive layer, designed for temporary protection from contamination and evaporation for samples in 96-well plates. A precut “X” over each well creates four flaps that easily bend downward when pushed by a robotic probe or pipet tip, allowing sample access without coring or adhesive fouling. A thin adhesive layer and special hairline cuts separating the X-Pierce flaps combine to prevent probes from contacting adhesive and becoming occluded. The flaps return to their original position after sampling for continued protection. For long-term sample protection after sampling, a continuous sealing film should be applied as a second layer.

- Protect samples and limit evaporation, short-term
- Special hairline X-cuts and thin adhesive prevent fouling or occlusion of probes and tips
- Sealing film reseals for continued sample protection after sampling
- Temperatures -40°C to +90°C
- Dimensions: 79.4mm x 145.5mm

Cat. No.	Description	Qty
XP-100	X-Pierce™ Sealing Films, Non-Sterile	100
XPS-25	X-Pierce™ Sealing Films, Sterile	50

Sealing Film for HPLC and LC/MS Applications



Easy Piercing Seal (EPS)

Easy Piercing Seal (EPS) punctures easily to prevent needle clogging or damage. In addition, no adhesive residues are left on the plate or injector needle. The EPS plate seal is made of polyolefin and is highly resistant to organic solvents. Some suggested applications are HPLC and LC/MS.

- Self-closes instantly
- High resistance to organic solvents such as DMSO, Acetonitrile, and Methanol
- Embossed design pierces easily to prevent needle clogging or damage
- Works with 96-, 384-, and 1536-well plates
- Airtight sealing between -80°C and +80°C
- Adhesive does not remain on the plate after peeling off
- Dimensions: 80mm x 122mm

Cat. No.	Description	Qty
RAPID EPS	RAPID EPS Easy Piercing Polyolefin Synthetic Adhesive Sealing Film for HPLC and LC/MS Applications	100

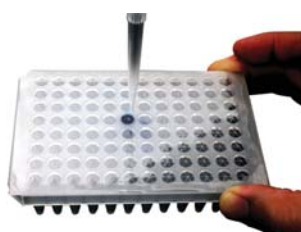

PET Silicone Adhesive Sealing Film

The Slit Seal is a resistant, instant self-closing 96-well plate seal. The adhesive-free, pre-cut slits made of silicone and PET allows easy insertion and withdrawal of pipette tips and sampling needles without dragging. The Slit Seal's main purpose is to prevent solvent evaporation and cross-contamination. Some suggested applications are Automation, SPE, HPLC, LC/MS, ADME, and organic synthesis.

- Self-closes instantly
- No cross-contamination between wells
- Allows next day analysis
- No adhesive on well spots
- Pipette tips insert easily with less friction
- Functional temperature range: -80°C to +37°C
- Dimensions: 80mm x 122mm

Cat. No.	Description	Qty
RAPID Slit	RAPID Slit PET Silicone Adhesive Sealing Film Pre-Slit for Automation, SPE, HPLC, LC/MS and ADME	100

Sealing Films for Cell and Tissue Culture, ELISA, EIA, and Similar Assays

Finneran Products Certified For Science™

AeraSeal™ Microporous Films for Cell and Tissue Culture



AeraSeal sealing films minimize cross-contamination, spillage and evaporation.

A 114µm thick hydrophobic porous sealing film with medical-grade adhesive for tissue culture plates, bio-blocks, and 96-well plates where gas exchange is necessary for cell or bacterial growth. They allow uniform air and CO₂ exchange for all wells, unlike plate lids which favor exchange for wells near the plate edges.

- Dimensions: 82.6mm x 142.9mm for standard-size tissue culture plates
- Non-cytotoxic, highly gas permeable
- Easily pierceable with pipet tips or pipets for sample recovery
- Recommended for temperatures from -20°C to +80°C

Cat. No.	Description	Qty
B-100	AeraSeal Microporous Film	100
BS-25	AeraSeal Microporous Film, Sterile, 2 zip bags of 25 each	50
RL-PLT-01	Accessory - Plate Roller*	1

* Completing application of sealing films by pressing with an accessory plate roller assures a secure uniform seal around all wells. The roller fits within the rim of a raised-well plate.

SealPlate® Sealing Films for ELISA, EIA, and Similar Assays

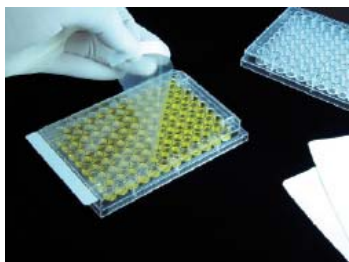

SealPlate™ Sealing Films

SealPlate® 50µm thickness polyester sealing films minimize evaporation, prevent spillage and contamination between wells, and provide a secure seal, not just a cover. Secure sealing of all wells eliminates “edge effects” in sensitive ELISA assays. SealPlate sealing films can also be used with tissue-culture plates for short-term storage, incubation, and containment of biohazards. SealPlate sealing films are non-pierceable. ThinSeal™ polyester sealing films are just 25µm thick, clearer and marginally pierceable with single-channel pipettes for sample recovery.

- Functional temperature range from -40°C to +120°C
- Available sterile and non-sterile
- Dimensions: 79.4mm x 141.0mm

Cat. No.	Description	Qty
100-SEAL-PLT	SealPlate Sealing Film, Non-Sterile	100
STR-SEAL-PLT	SealPlate Sealing Film, Sterile	100
100-THIN-PLT	ThinSeal Sealing Film, Non-Sterile	100
STR-THIN-PLT	ThinSeal Sealing Film, Sterile	100

SealPlate® MiniStrips for ELISA, EIA, and Similar Assays



SealPlate MiniStrips

SealPlate® MiniStrips sealing films are identical to SealPlate films above, but designed for sealing only one or two 8-well rows at a time on either strip-well or standard plates whenever rows must be selectively protected or accessed. Each MiniStrips film is 19.0mm x 103.2mm, including two positioning tabs. The long dimension with the tabs removed is 82.6mm. MiniStrips are supplied in sheets of four from which strips can be peeled individually or two-at-a-time for application to plates. Sterile product is packaged in 200µm tamper-evident bags of 200. Two tabs on each strip for easy application and removal.

- Perforated tabs can be removed or sealed around plate edge
- Can be used as secondary seal to cover sealing films that have been pierced

Cat. No.	Description	Qty
SP-2x8-50	SealPlate MiniStrips, Non-Sterile	200 Strips
SPS-2x8-50	SealPlate MiniStrips, Sterile	200 Strips

Sealing Films for PCR and Cold Storage

Finneran Products Certified For Science™

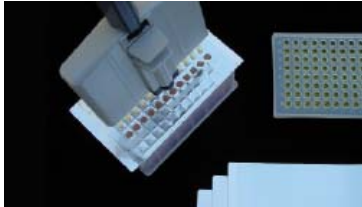

Each sealing film measures 82.6mm x 146.1mm and offers sufficient sealing area for all PCR plates. Length between the perforations with end tabs removed is 125.4mm

AlumaSeal II™ Sealing Film for PCR and Cold Storage

A 38µm soft non-permeable aluminum foil sealing film with strong medical-grade adhesive, AlumaSeal II™ sealing films eliminate the need for heat-sealing devices or mats during thermal cycling. Compared to other aluminum foils, AlumaSeal II has less tendency to roll back on itself when removing the backing paper and conforms well to the plate during application.

- Easily pierceable with single or multichannel pipettors and robotic probes
- Heat and cold resistant, recommended for temperatures from -80°C to 120°C
- Certified DNase-, RNase-, and nucleic-acid-free
- Excellent barrier properties, virtually no sample evaporation or drying

Cat. No.	Description	Qty
AF-100	AlumaSeal II Sealing Film	100
RL-PLT-01	Accessory - Plate Roller	1

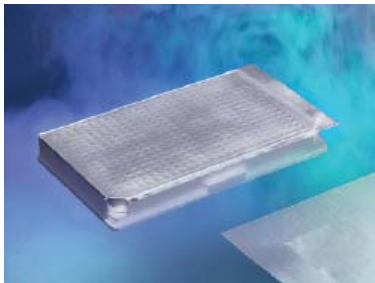

Dimensions are 82.6mm x 132.6mm, including the single 9.5mm end tab.

AlumaSeal CS™ Sealing Film for Cold Storage

AlumaSeal CS™ sealing films are specially formulated aluminum foil sealing films with an adhesive that withstands cold storage at temperatures to -80°C. Unlike other sealing films in the AlumaSeal group, AlumaSeal CS™ sealing films are not recommended for PCR or thermocycling. A single non-perforated end tab simplifies application. Simply hold the tab and strip the backing from the body of the sealing film as it lays on the plate to avoid curling.

- Recommended temperature range: -80°C to +130°C
- Certified DNase-, RNase-, and nucleic-acid-free
- Excellent barrier properties to retard evaporation
- Easily pierceable with pipet tips or robotic probes for sample recovery

Cat. No.	Description	Qty
FC-100	AlumaSeal CS™ Sealing Film	100
RL-PLT-01	Accessory - Plate Roller	1



Dimensions are 82.5mm x 137.3mm, including the single 13.5mm end tab.

AlumaSeal 384™ Sealing Film

A 38µm thick aluminum foil sealing film with 38µm layer of acrylic adhesive for use with 384-well plates. AlumaSeal 384™ sealing films have one end tab with no perforations. Pierceable. Available non-sterile only. Sealing film dimensions are 137.3 x 82.5mm (including single 13.5mm end tab).

- Heat & cold resistant, recommended for temperatures from -80 °C to +120 °C
- Certified DNase-, RNase-, and nucleic-acid-free

* Completing application of AlumaSeal 384 sealing films by pressing with the accessory plate roller assures a secure uniform seal around all wells.

Cat. No.	Description	Qty
F-384-100	AlumaSeal 384 Sealing Film, Non-Sterile	100
RL-PLT-01	Accessory - Plate Roller	1

Sealing Films for PCR and Cold Storage

ThermalSeal® Sealing Films for PCR



ThermalSeal™ Sealing Films

50µm heat-resistant polypropylene sealing film designed for thermal cycling applications. (Not recommended for PCR plates with narrow or irregular sealing surfaces). Length between the perforations with end tabs removed is 123.1mm. ThermalSeal sealing films are not pierceable. For applications where piercing with pipet tips or robotic probes is required for product recovery, see AlumaSeal II sealing films.

- Heat and cold resistant, recommended for temperatures from -40°C to +120°C
- Easier to apply than aluminum foils, no tendency to roll back
- Certified DNase-, RNase-, and nucleic-acid-free
- Dimensions: 79.4mm x 135.1mm, sufficient sealing area for all PCR plates

Cat. No.	Description	Qty
100-THER-PLT	ThermalSeal™ Sealing Film	100
STR-THER-PLT	ThermalSeal™ Sealing Film, Sterile	100
RL-PLT-01	Accessory - Plate Roller	1

ThermalSeal® RT™ Sealing Films for Real-Time PCR

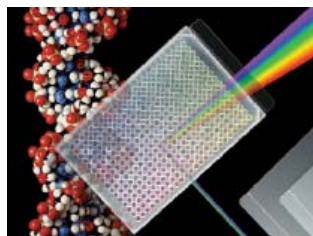

ThermalSeal RT™ Sealing Films

ThermalSeal RT™ sealing films combine an optically transparent polyester sealing film with a strong, ultra-smooth, non-absorbing, non-fluorescing medical-grade adhesive for superior performance in real-time PCR applications. In place of the customary paper backing, ThermalSeal RT™ sealing films have a plastic liner which is easily removed before use and contributes smoothness and extreme optical clarity to the adhesive. Length between the perforations with end tabs removed is 121.9mm.

- “Brilliant” ultra-high optical clarity
- Heat resistant, recommended for temperatures from -40°C to +120°C
- Certified DNase-, RNase-, and nucleic-acid-free
- Dimensions: 79.4mm x 142.9mm

Cat. No.	Description	Qty
TS-RT2-100	ThermalSeal RT™ 50-µm-thick Sealing Film, Non-Sterile	100
RL-PLT-01	Accessory - Plate Roller	1

ThermalSeal 2™ Sealing Films for PCR

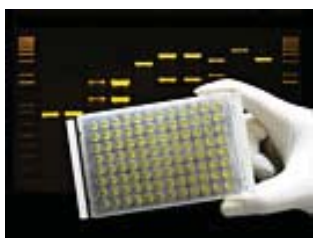

ThermalSeal 2™ Sealing Films

These improved films for classic thermal cycling applications consist of a 50µm polyester film with a 41µm layer of acrylic adhesive. Compared to the original ThermalSeal® films (above), ThermalSeal 2™ films offer better adhesion, reduced evaporation, longer end tabs for easier handling, and less tendency to tear during removal from the plate. Each sealing film offers sufficient sealing area for all PCR plates. Length between the perforations with end tabs removed is 125.1 mm. (Not recommended for raised-rim plates; see ThermalSeal A™ films). ThermalSeal 2™ sealing films are not pierceable. For applications where piercing with pipet tips or robotic probes is required for product recovery, see AlumaSeal® sealing films. For real-time PCR applications where maximum optical clarity is required, see ThermalSeal RT™ and RTS™ sealing films.

- Heat resistant, recommended for temperatures from -40°C to +120°C
- Better adhesion; reduced evaporation
- Longer tabs for easier handling
- Does not tear when removing from plate
- Certified DNase-, RNase-, and nucleic-acid-free
- Dimensions: 79.4mm x 139.7mm

Cat. No.	Description	Qty
TS2-100	ThermalSeal 2™ Sealing Films; Polyester, 50µm Thick, Non-Pierceable, Better Adhesion, Non-Sterile	100
RL-PLT-01	Accessory - Plate Roller	1

Sealing Films for PCR and Cold Storage

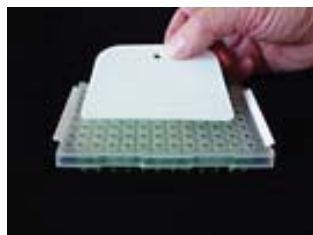

ThermalSeal A™ Sealing Films

ThermalSeal A™ Sealing Films for PCR and Storage

ThermalSeal A™ sealing films are an advanced version of the ThermalSeal® sealing films for PCR. ThermalSeal A™ films consist of 50µm polyester film with a 41µm layer of acrylic adhesive formulated for improved protection against evaporation and leakage during thermal cycling. Intended for non real-time PCR applications, ThermalSeal A™ films are designed to fit inside the edge of raised-rim PCR plates and provide more secure sealing of all wells because the center of the film does not extend over the plate rim. Two end tabs allow for easy positioning of the film on the plate but are perforated for easy removal if necessary. Length between the perforations with end tabs removed is 118.1mm. Each package of ThermalSeal A™ films includes one sealing paddle for ensuring a firm seal, also compatible with raised-rim plates.

- Heat resistant, recommended for temperatures from -40°C to +120°C
- Can be used with raised-rim PCR plates and standard plates
- Two end tabs, perforated for easy removal
- Certified DNase-, RNase-, and nucleic-acid-free
- Dimensions: 77.8mm x 135.5mm overall

Cat. No.	Description	Qty
TSA-100	ThermalSeal A™ Sealing Films; Narrow Sealing Surface, Polyester, 50µm Thick, Non-Pierceable	100
PDL-5	Film-Sealing Paddles for Pressing Film to Plate, works within edges of Raised-Rim Plates (10 packs of 5)	50

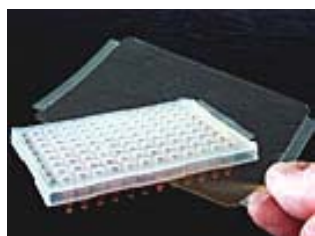

ThermalSeal RT2RR™ Sealing Films

ThermalSeal RT2RR™ Sealing Films for Real-Time PCR

ThermalSeal RT2RR™ 50µm polyester sealing films for real-time PCR are sized to fit within the edges of raised-rim 96-well plates. The same consistent ultra-high optical clarity as ThermalSeal RT™ sealing films makes possible more reproducible, reliable, and consistent DNA amplification measurements. An inert, strong, temperature-resistant adhesive assures reliable sealing around each well. Two end tabs assist in positioning the sealing film. Easy removal of the end tabs at perforated boundaries prevents lifting and higher evaporation rates that can occur with sealing films that overlap the plate rim. Recommended for specific DNA sequence detection in clinical diagnostics, forensic science and basic research. With end tabs removed, length is 118.1mm with 45° corners.

- Ultra-high optical clarity
- Fit within plate rim to prevent evaporation due to sealing film lifting
- Heat resistant, recommended for temperatures from -40°C to +120°C
- Certified DNase-, RNase-, and nucleic-acid-free
- Dimensions: 77.8mm x 130.8mm

Cat. No.	Description	Qty
TS-RT2RR-100	ThermalSeal RT2RR™ Sealing Films; Polyester 50µm-thick Sealing Films, Non-Sterile	100
PDL-5	Film-Sealing Paddles for Pressing Film to Plate, works within edges of Raised-Rim Plates (10 packs of 5)	50

Sealing Films for PCR and Cold Storage

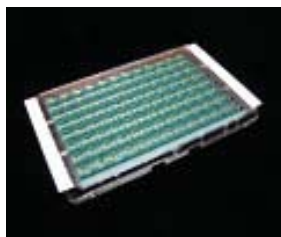

ThermalSeal RTS™ Sealing Films



ThermalSeal RTS™ Sealing Films for qPCR, Storage & Crystallization

ThermalSeal RTS™ sealing films are based on 50µm polyolefin films with 50µm inert encapsulated silicone adhesive. They are optically clear, with low autofluorescence, and are especially suited for real-time qPCR, storage, and protein crystallization applications. The encapsulated silicone adhesive is non-tacky until pressed against the sealing surface, at which time adhesive is released only in sealing areas to form the strongest available heat-resistant seal around each well on the plate. Adhesive on non-sealing areas of the film, such as directly over sample wells, remains encapsulated and inert. Sized to fit within the edges of raised-rim 96-well plates. Their consistent high optical clarity makes possible reproducible, reliable, and consistent DNA amplification measurements and crystal detection. Two end tabs assist in positioning the film on the plate, and the non-tacky adhesive surface simplifies handling. Easy removal of the end tabs at perforated boundaries prevents lifting and higher evaporation rates that can occur with films that overlap the plate rim. With end tabs removed, length is 113.0 mm.

- High optical clarity
- Minimal to no autofluorescence
- Chemically inert; no extractables except at extreme pH
- DMSO resistant for HTS
- Heat resistant, recommended for temperatures from -70°C to +100°C
- Certified DNase-, RNase-, and nucleic-acid-free
- Fit within raised plate rim to prevent loss of seal due to film lifting
- Silicone adhesive forms the strongest available seal for evaporation prevention
- Non-tacky adhesive layer simplifies handling of film prior to sealing
- Dimensions: 78.6mm by 139.7mm

Cat. No.	Description	Qty
TSS-RTQ-100	ThermalSeal RTS™ Sealing Films: Non-Sterile	100
PDL-5	Film-Sealing Paddles for Pressing Film to Plate, works within edges of Raised-Rim Plates (10 packs of 5)	50

eXTReme™ FoilSeal™



eXTReme™ FoilSeal™

XTR foils offer high performance under extreme conditions. A 48µm soft non-permeable aluminum foil sealing film with 30µm layer of strong acrylic adhesive. FoilSeal™ sealing foils remove cleanly from plate surfaces with no adhesive stringing, residue or contamination. Each sealing foil measures 78.3 x 129mm and offers sufficient sealing area for all plate types (e.g. flat top and raised-rim). Chamfered corners result in no plate overhang for robotics applications. Features one end-tab with perforations. Length between the perforation, with end tab removed and the end of the foil seal, is 118.1mm.

- Universal fit for use with all plate types (e.g. flat top and raised-rim)
- The smaller dimensions and chamfered corners result in no plate overhang for robotics applications
- Single end-tab features a custom perforation that will not tear during removal
- Certified DNase- and RNase- free
- Excellent barrier properties minimizes sample evaporation
- 1.9mil thick aluminum foil minimizes shredding during removal and is ideal for cold storage
- Conformable foil allows visual verification of seal security
- Pierceable with pipet tips and robotic probes for direct sample retrieval
- Specially formulated adhesive provides an excellent seal for all plate materials (e.g. polystyrene, polypropylene and two component polycarbonate/polypropylene PCR plates)
- Foil will remove cleanly from plate surfaces with no adhesive stringing or residue

Cat. No.	Description	Qty
XTR-FOIL-100	eXTReme FoilSeal, Non-Sterile	100
RL-PLT-01	Accessory - Plate Roller	1

Sealing Films for PCR and Cold Storage

eXTReme™ Seal

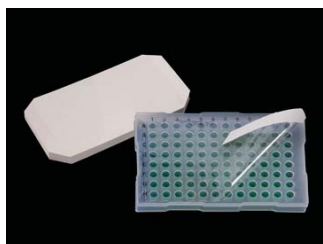

eXTReme™ Seal

XTR films offer high performance under extreme conditions. A 2mil polyester film with a 1.65mil layer of strong acrylic adhesive. eXTReme Seal films remove cleanly from plate surfaces without adhesive stringing, residue or contamination. Each sealing film measures 78.3 x 140.5mm and offers sufficient sealing area for all plate types (e.g. flat top and raised-rim). Chamfered corners result in no plate overhang for robotics applications. Features two end-tabs with perforations. Length between perforations, with end tabs removed, is 119mm.

- Universal fit for use with all plate types (e.g. flat top and raised-rim)
- The smaller dimensions and chamfered corners result in no plate overhang for robotics applications
- Two end-tab feature allows for ease of placement of film to plate
- Certified DNase- and RNase- free
- Excellent seal minimizes sample evaporation and reduces well-to-well cross contamination
- Specially formulated adhesive provides an excellent seal for all plate materials, including polycarbonate
- 2mil polyester film will remove cleanly from plate surfaces with no adhesive stringing or residue and will not tear upon removal

Cat. No.	Description	Qty
XTR-100	eXTReme Seal, Non-Sterile	100
RL-PLT-01	Accessory - Plate Roller	1

Molded Sealing Mats for Standard 96-Well Microplates

Finneran Products Certified For Science™



- Designed to fit Standard 96-Well Microplates
- Silicone provides excellent resealability, resists coring and tearing after multiple needle injections
- Molded mats are autoclavable and have excellent chemical compatibility
- Manufactured from medical grade Silicone
- Tight seal in plate, eliminates sample cross contamination and evaporation
- Available prescored for easier needle penetration
- Alphanumeric grid references
- No coring or cross-talk
- Unscored Mats are good with aggressive solvents and extreme shaking
- Pre-Scored Mats are good with aggressive solvents

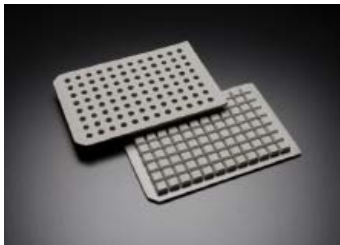

Gray Molded (non-spray-coated) PTFE-lined/Silicone Sealing Mat

Cat. No.	Description	Qty
996050MR-96	96 Round Well Gray PTFE/Silicone Mat	5
996075MR-96	96 Round Well Prescored Gray PTFE/Silicone Mat	5
996050SW-96	96 Square Well Gray PTFE/Silicone Mat	5
996075SW-96	96 Square Well Prescored Gray PTFE/Silicone Mat	5

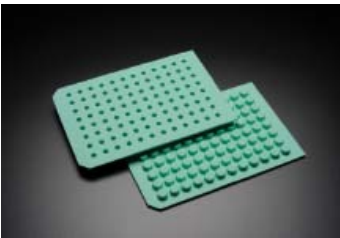

Green Silicone Only Molded Mat

Cat. No.	Description	Qty
997005MR-96	96 Round Well Green Silicone-Only Mat	5
997075MR-96	96 Round Well Prescored Green Silicone-Only Mat	5
997005SW-96	96 Square Well Green Silicone-Only Mat	5
997075SW-96	96 Square Well Prescored Green Silicone-Only Mat	5

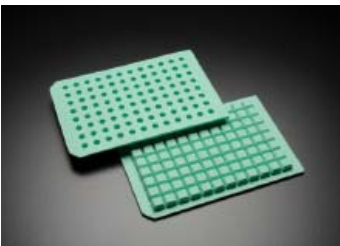

Molded Sealing Mats for Standard 96-Well Microplates

Clear Molded (spray-coated) PTFE/Premium Silicone Sealing Mat

- Mats sprayed with a PTFE coating for increased chemical resistance
- Manufactured from soft, strong premium silicone and conditioned for Ultra Low Bleed
- No interfering peaks



9760507MR-96

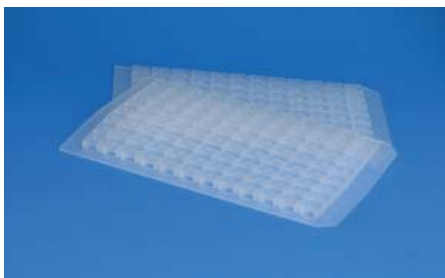

976075SW-96

Cat. No.	Description	Qty
9760507MR-96	96 Round Well (7mm Diameter Plug) Clear Sealing Mat with Spray Coated PTFE/Premium Silicone	5
9760757MR-96	96 Round Well Pre-Slit (7mm Diameter Plug) Clear Sealing Mat with Spray Coated PTFE/Premium Silicone	5
9762507MR-96	96 Round Well Ultra Low Bleed (7mm Diameter Plug) Clear Sealing Mat with Spray Coated PTFE/Premium Silicone	5
9762757MR-96	96 Round Well Pre-Slit Ultra Low Bleed (7mm Diameter Plug) Clear Sealing Mat with Spray Coated PTFE/Premium Silicone	5
9760508MR-96	96 Round Well (8mm Diameter Plug) Clear Sealing Mat with Spray Coated PTFE/Premium Silicone	5
9760758MR-96	96 Round Well Pre-Slit (8mm Diameter Plug) Clear Sealing Mat with Spray Coated PTFE/Premium Silicone	5
9762508MR-96	96 Round Well Ultra Low Bleed (8mm Diameter Plug) Clear Sealing Mat with Spray Coated PTFE/Premium Silicone	5
9762758MR-96	96 Round Well Pre-Slit Ultra Low Bleed (8mm Diameter Plug) Clear Sealing Mat with Spray Coated PTFE/Premium Silicone	5
9764508MR-96	96 Round Well (8mm Diameter & Short Plug) Clear Sealing Mat with Spray Coated PTFE/Premium Silicone	5
9764758MR-96	96 Round Well Pre-Slit (8mm Diameter & Short Plug) Clear Sealing Mat with Spray Coated PTFE/Premium Silicone	5
976050SW-96	96 Square Well Clear Sealing Mat with Spray Coated PTFE/Premium Silicone	5
976075SW-96	96 Square Well Pre-Slit Clear Sealing Mat with Spray Coated PTFE/Premium Silicone	5
976250SW-96	96 Square Well Ultra Low Bleed Clear Sealing Mat with Spray Coated PTFE/Premium Silicone	5
976275SW-96	96 Square Well Pre-Slit Ultra Low Bleed Clear Sealing Mat with Spray Coated PTFE/Premium Silicone	5

8 and 12 Channel Reservoir Trough Plate for Multi-Channel Pipettors

Finneran Products Certified For Science™

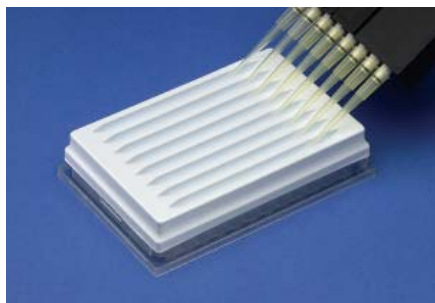

8 Channel Trough

1mL to 7mL capacity per channel
56mL Total Capacity

12 Channel Trough

1mL to 3mL capacity per channel
36mL Total Capacity

Made from either
High Impact White Polystyrene
or
Clear PETG (PolyEthylene Terephthalate)
Autoclavable

J.G. Finneran Associates has introduced 8 and 12 channel reservoir trough plates to help improve convenience and productivity in high-throughput laboratories. The troughs hold liquid reagents in precise rows that align with 8-channel and 12-channel pipettes allowing researchers to simultaneously aspirate or dispense fluids in all channels. The product helps high throughput laboratories improve productivity because researchers can improve their speed and precision performing serial dilutions or dispensing different reagents in up to 12 channels.

The 8 and 12 channel reservoir trough plates are constructed of high impact plastics for durable, long-term performance; either polystyrene or polyethylene terephthalate (PETG). The reservoir design incorporates a v-shaped bottom with a residual volume of 200µL, reducing dead volume and minimizing waste. For benchtop stability, the trough plates fit snugly on top of the Finneran 96-well Multi-Tier™ microplate system. The 8-channel plate has a total capacity of 56mL, with a 1mL to 7mL capacity per channel. The 12-channel plate has a 36mL total capacity with a trough capacity of 1mL to 3mL. Researchers will rely on these handy tools for adding samples, standards, wash, rinses, or reagents in high-throughput applications that involve use of multichannel pipettes. They also can be used for Invitro incubation, drug-to-drug interaction and caco-2 cells.

- *Trough fits on Multi-Tier™ Base Plate for added stability*
- *V-bottom has 200µL residual volume*
- *Designed to minimize dead volume in high-throughput clean-up applications*



Reservoir Trough Plate

Cat. No.	Description	Qty
TR100-08	8 Channel Reservoir, White Polystyrene	5
TR100-08PETG	8 Channel Reservoir, Clear PETG	5
TR100-12	12 Channel Reservoir, Clear PETG	5
TR100-12PS	12 Channel Reservoir, White Polystyrene	5
TR100-812C	Clear Cover for Reservoir	5

Base Plate Accessory

Cat. No.	Description	Qty
9996-812	Base Plate, ABS (Acrylic Butyl Styrene)	1
9996-812T	Base Plate, Topas (COC - Cyclic Olefin Copolymer)	1

Polypropylene Plastic Pasteur Pipets

Finneran Products Certified For Science™



New Polypropylene Plastic Pasteur Pipet provides chemical resistivity needed for many applications.

- Available in two sizes: 5.75" and 9" for easier handling and longer reach for working with larger vessels
- Available in sterile (gamma irradiated) and non-sterile pack options

Addresses many of the concerns associated with glass:

Safety

- No more broken glass – more durable than standard glass pipets
- Flexible plastic helps prevent glove or skin punctures

Efficiency

- Polypropylene Pipet will not shatter, eliminating losses due to broken glass fragments in your work
- Can be autoclaved

Value

- Saves time and money - Use all the pipets in the box, as compared to traditional glass Pasteur pipets which are often damaged during shipping or handling
- Reduce cost by eliminating “sharps” disposal

Convenience

- Polypropylene Pipets are available packaged non-sterile in re-sealable bags with 100 pipets per bag
- Also available packaged sterile (gamma irradiated) bulk packed with 25 pipets per resealable bag, so no autoclaving is necessary before use



Polypropylene Plastic Pasteur Pipets

Cat. No.	Description	Qty
JGFPP-575-S	Pipet, 5.75" Length, Bulk Packed, 25 per Re-Sealable Bag, Sterile	500
JGFPP-575	Pipet, 5.75" Length, Bulk Packed, 100 per Re-Sealable Bag, Non-Sterile	500
JGFPP-575-B	Pipet, 5.75" Length, Bulk Packed, 200 per Tab Lock Box, Non-Sterile	1000
JGFPP-9-S	Pipet, 9" Length, Bulk Packed, 25 per Re-Sealable Bag, Sterile	500
JGFPP-9	Pipet, 9" Length, Bulk Packed, 100 per Re-Sealable Bag, Non-Sterile	500
JGFPP-9-B	Pipet, 9" Length, Bulk Packed, 200 per Tab Lock Box, Non-Sterile	1000



Double Ended Cell Lifter

Finneran Products Certified For Science™

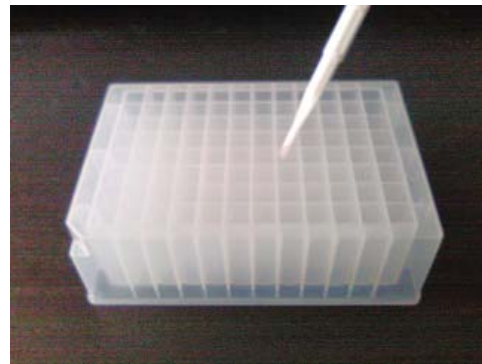
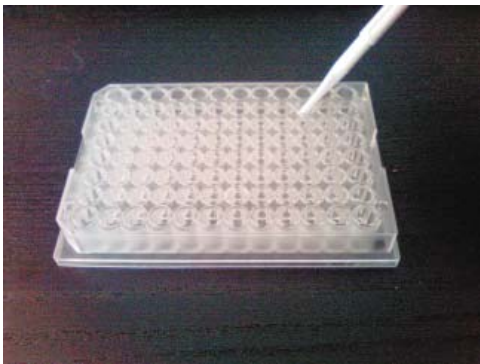

- Double Ended Cell Lifters have a 19mm Beveled Edge Blade on one end and a Narrow Blade on the other for removing cells from Multiple Well Plates or Tubes.
- The Narrow Blade version is tapered on one end to fit into 96 Well Plates or Micro Centrifuge Tubes

Double Ended Cell Lifter

Cat. No.	Description	Qty
JGF305	Double Ended Cell Lifter, 19mm Beveled Edge Blade and Narrow Blade	100

Cardboard Freezer Storage Boxes

Finneran Products Certified For Science™

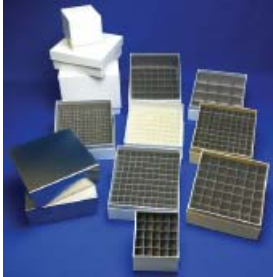

- Economical storage solution for cryovials, cold storage sample vials and centrifuge tubes
- Constructed of sturdy, durable cardboard
- Four drain holes on each corner for safe liquid nitrogen or excess moisture drainage
- Boxes are available with or without cell dividers
- Cell dividers are available in 100, 81, 64, 49, 36, 25 or 16 place configurations
- Compatible with most upright laboratory storage rack systems
- Can withstand temperature extremes of -196°C to +121°C
- Surface of lid can be easily written on for identification
- 4¾" cardboard box for 1.5mL and 50mL Centrifuge Tubes

Case Pack - 1 piece

Cat. No.	Description
CB982-W	Standard White 2" Cardboard Box Only - 5 1/4" × 5 1/4" × 2"
CB982-Y	Standard Yellow 2" Cardboard Box Only - 5 1/4" × 5 1/4" × 2"
CB982-W-100	Standard White 2" Cardboard Box Assembled with Dividers, 100 Cell - 5 1/4" × 5 1/4" × 2"
CB982-W-81	Standard White 2" Cardboard Box Assembled with Dividers, 81 Cell - 5 1/4" × 5 1/4" × 2"
CB982-W-64	Standard White 2" Cardboard Box Assembled with Dividers, 64 Cell - 5 1/4" × 5 1/4" × 2"
CB982-W-49	Standard White 2" Cardboard Box Assembled with Dividers, 49 Cell - 5 1/4" × 5 1/4" × 2"
CB982-W-36	Standard White 2" Cardboard Box Assembled with Dividers, 36 Cell - 5 1/4" × 5 1/4" × 2"
CB982-W-25	Standard White 2" Cardboard Box Assembled with Dividers, 25 Cell - 5 1/4" × 5 1/4" × 2"
CB982-W-16	Standard White 2" Cardboard Box Assembled with Dividers, 16 Cell - 5 1/4" × 5 1/4" × 2"
CB982-Y-100	Standard Yellow 2" Cardboard Box Assembled with Dividers, 100 Cell - 5 1/4" × 5 1/4" × 2"
CB982-Y-81	Standard Yellow 2" Cardboard Box Assembled with Dividers, 81 Cell - 5 1/4" × 5 1/4" × 2"
CB982-Y-64	Standard Yellow 2" Cardboard Box Assembled with Dividers, 64 Cell - 5 1/4" × 5 1/4" × 2"
CB982-Y-49	Standard Yellow 2" Cardboard Box Assembled with Dividers, 49 Cell - 5 1/4" × 5 1/4" × 2"
CB982-Y-36	Standard Yellow 2" Cardboard Box Assembled with Dividers, 36 Cell - 5 1/4" × 5 1/4" × 2"
CB982-Y-25	Standard Yellow 2" Cardboard Box Assembled with Dividers, 25 Cell - 5 1/4" × 5 1/4" × 2"
CB982-Y-16	Standard Yellow 2" Cardboard Box Assembled with Dividers, 16 Cell - 5 1/4" × 5 1/4" × 2"
CB983-W	Standard White 3" Cardboard Box Only - 5 1/4" × 5 1/4" × 2 15/16"
CB983-W-100	Standard White 3" Cardboard Box Assembled with Dividers, 100 Cell - 5 1/4" × 5 1/4" × 2 15/16"
CB983-W-81	Standard White 3" Cardboard Box Assembled with Dividers, 81 Cell - 5 1/4" × 5 1/4" × 2 15/16"
CB983-W-64	Standard White 3" Cardboard Box Assembled with Dividers, 64 Cell - 5 1/4" × 5 1/4" × 2 15/16"
CB983-W-49	Standard White 3" Cardboard Box Assembled with Dividers, 49 Cell - 5 1/4" × 5 1/4" × 2 15/16"
CB983-W-36	Standard White 3" Cardboard Box Assembled with Dividers, 36 Cell - 5 1/4" × 5 1/4" × 2 15/16"
CB983-W-25	Standard White 3" Cardboard Box Assembled with Dividers, 25 Cell - 5 1/4" × 5 1/4" × 2 15/16"
CB983-W-16	Standard White 3" Cardboard Box Assembled with Dividers, 16 Cell - 5 1/4" × 5 1/4" × 2 15/16"
CB984-W	Standard White 4 3/4" Cardboard Box with Drain Hole - 5 3/4" × 5 3/4" × 4 3/4"
CB984-W-36	Standard White 4 3/4" Cardboard Box with Drain Hole Assembled with Dividers, 36 Cell - 5 3/4" × 5 3/4" × 4 3/4"
CB984-W-16	Standard White 4 3/4" Cardboard Box with Drain Hole Assembled with Dividers, 16 Cell - 5 3/4" × 5 3/4" × 4 3/4"
MB982-W	White 2" Cardboard Mini Box with Drain Slots - 3" × 3" × 2"
MB982-W-25	White 2" Cardboard Mini Box with Drain Slots Assembled with Dividers, 25 Cell - 3" × 3" × 2"
MB983-W	White 3" Cardboard Mini Box with Drain Slots - 3" × 3" × 3"
MB983-W-25	White 3" Cardboard Mini Box with Drain Slots Assembled with Dividers, 25 Cell - 3" × 3" × 3"

Cardboard Freezer Storage Boxes

Freezer Box Dividers

Shelf Pack - 1 piece, Case Pack - 10 pieces

Cat. No.	Description
CD98-100	Cell Divider Only, Standard Box, 100 Cell - 4 6/7" × 4 6/7" × 1 5/16" - 0.45" (11.5mm) Cell Opening
CD98-81	Cell Divider Only, Standard Box, 81 Cell - 4 6/7" × 4 6/7" × 1 5/16" - 0.50" (12.7mm) Cell Opening
CD98-64	Cell Divider Only, Standard Box, 64 Cell - 4 6/7" × 4 6/7" × 1 5/16" - 0.57" (14.6mm) Cell Opening
CD98-49	Cell Divider Only, Standard Box, 49 Cell - 4 6/7" × 4 6/7" × 1 5/16" - 0.66" (16.7mm) Cell Opening
CD98-36	Cell Divider Only, Standard Box, 36 Cell - 4 6/7" × 4 6/7" × 1 5/16" - 0.82" (20mm) Cell Opening
CD98-25	Cell Divider Only, Standard Box, 25 Cell - 4 6/7" × 4 6/7" × 1 5/16" - 0.96" (24.5mm) Cell Opening
CD98-16	Cell Divider Only, Standard Box, 16 Cell - 4 6/7" × 4 6/7" × 1 5/16" - 1.19" (30.2mm) Cell Opening
CD984-36	Cell Divider Only, 4" Standard Box, 36 Cell for Centrifuge Tubes- 5 3/8" × 5 3/8" × 2 6/8" - 0.85" (22mm) Cell Opening
CD984-16	Cell Divider Only, 4" Standard Box, 16 Cell for Centrifuge Tubes- 5 3/8" × 5 3/8" × 2 6/8" - 1.32" (33.5mm) Cell Opening



4mm, 13mm, and 25mm Syringe Filters

All Finneran Products Are Certified



Our syringe filters are made using polypropylene medical-grade housings with Luer-Lock and Luer-Slip fittings in compliance with ISO 594-1. Each filter is sealed, using an external ring insert, to maintain the membrane integrity and best performance. Filters are color-coded for easy identification.

The Certified Filters are supplied with a Certificate of Quality, batch-to-batch, to guarantee product performance and quality. The filters are visually inspected following quality specifications. Each batch of filters is tested for external dimensions, bubble point, filter integrity, water flow rate, UV extractable, and compliance with all technical procedures, manufacturing specifications, and quality controls for release. Tests are performed by an independent laboratory.

General Specifications

Syringe filters are available in two sizes (13 and 25 mm Ø) with a variety of membranes.

Filter size	Sample volume size (*)	Hold- up volume (after air purge)	Filtration area	Max. operating pressure	External dimensions	Weight
13mm	1-10 mL	< 30 µL	0.95 cm ²	750 kPa	6.2 ±0.3mmØ x 19.0 ±0.3mm	10.90 ±0.10g
13mm PF	1-5 mL	< 25 µL	0.95 cm ²	750 kPa	16.2 ±0.3mmØ x 17.3 ±0.3mm	0.80 ±0.10g
25mm	>10 mL	< 120 µL	3.55 cm ²	650 kPa	31.9 ±0.3mmØ x 25.7 ±0.3mm	3.90 ±0.10g
25mm R	>10 mL	< 120 µL	3.55 cm ²	650 kPa	30.0 ±0.3mmØ x 21.5 ±0.3mm	3.90 ±0.10g
25mm A	>10 mL	<150 µL	3.55 cm ²	650 kPa	30.0 ±0.3mmØ x 21.3 ±0.3mm	2.90 ±0.10g

(*) For critical applications using chromatography detection at < 210nm is recommended to reject the first filtrated ml.

Membrane selection

In the selection of membrane for chromatography sample and solvent filtration, there are several important considerations:

- The membrane must be highly solvent resistant, since most chromatography solvents are aggressive and sometimes corrosive.
- It should not have extractables because they can interfere with analytical results.
- It should be a low protein binding membrane for biological samples.

Special Formats Available

Robot filters (low hold-up volume) designed for robotic devices (25mm R).

Automatic filters (high stress resistance) available for automatic applications (25mm A).

Mini-tip filters (for small quantities of analytical samples) (13mm PF)

Connection Luer-lock full screw (available on 13mm Filters)

Traceability on Certified Filters

Certified filters, with Traceability, are available on standard products. These filters have PRINTED, externally, a color-coded plastic ring with the BATCH NUMBER (i.e. LOT 123456). This batch number provides extended certification and traceable documentation in accordance with ISO protocol.

4mm, 13mm, and 25mm Syringe Filters

4mm Syringe Filters

Available in 1.0 μ m, 2.0 μ m and 5.0 μ m pore sizes. Glass fiber membranes have fast filtration flow, eliminate sample contamination, and have good chemical compatibility. Autoclavable.

Case Pack - 100 pieces

Cat. No. Description

Cat. No.	Description
FEC0204PC	4mm Syringe Filter, 0.2 μ m Mixed Esters Cellulose, Light Yellow
FEC0404PC	4mm Syringe Filter, 0.45 μ m Mixed Esters Cellulose, Dark Yellow
FPV0204PC	4mm Syringe Filter, 0.2 μ m PVDF, Light Red
FPV0404PC	4mm Syringe Filter, 0.45 μ m PVDF, Dark Red
FN0204PC	4mm Syringe Filter, 0.2 μ m Nylon, Light Green
FN0404PC	4mm Syringe Filter, 0.45 μ m Nylon, Dark Green
FPT0204PC	4mm Syringe Filter, 0.2 μ m PTFE, Light Blue
FPT0404PC	4mm Syringe Filter, 0.45 μ m PTFE, Dark Blue
FPP0204PC	4mm Syringe Filter, 0.2 μ m Polypropylene, Transparent
FPP0404PC	4mm Syringe Filter, 0.45 μ m Polypropylene, White
FRC0204PC	4mm Syringe Filter, 0.2 μ m Regenerated Cellulose, Light Brown
FRC0404PC	4mm Syringe Filter, 0.45 μ m Regenerated Cellulose, Dark Brown
FAC0204PC	4mm Syringe Filter, 0.2 μ m Cellulose Acetate, Light Orange
FAC0404PC	4mm Syringe Filter, 0.45 μ m Cellulose Acetate, Dark Orange
FPS0204PC	4mm Syringe Filter, 0.2 μ m Polyethersulfone, Light Purple
FPS0404PC	4mm Syringe Filter, 0.45 μ m Polyethersulfone, Dark Purple
FGF1004PC	4mm Syringe Filter, 1.0 μ m Glass Fiber, Grey
FGF2004PC	4mm Syringe Filter, 2.0 μ m Glass Fiber, Grey
FGF5004PC	4mm Syringe Filter, 5.0 μ m Glass Fiber, Grey



4mm, 13mm, and 25mm Syringe Filters



13mm Syringe Filters

Available in 1.0 μ m, 2.0 μ m and 5.0 μ m pore sizes. Glass fiber membranes have fast filtration flow, eliminate sample contamination, and have good chemical compatibility. Autoclavable.

Case Pack - 100 pieces

Cat. No.	Description
FEC0213PC	13mm Syringe Filter, 0.2 μ m Mixed Esters Cellulose, Light Yellow
FEC0413PC	13mm Syringe Filter, 0.45 μ m Mixed Esters Cellulose, Dark Yellow
FPV0213PC	13mm Syringe Filter, 0.2 μ m PVDF, Light Red
FPV0413PC	13mm Syringe Filter, 0.45 μ m PVDF, Dark Red
FNY0213PC	13mm Syringe Filter, 0.2 μ m Nylon, Light Green
FNY0413PC	13mm Syringe Filter, 0.45 μ m Nylon, Dark Green
FPT0213PC	13mm Syringe Filter, 0.2 μ m PTFE, Light Blue
FPT0413PC	13mm Syringe Filter, 0.45 μ m PTFE, Dark Blue
FPP0213PC	13mm Syringe Filter, 0.2 μ m Polypropylene, Transparent
FPP0413PC	13mm Syringe Filter, 0.45 μ m Polypropylene, White
FRC0213PC	13mm Syringe Filter, 0.2 μ m Regenerated Cellulose, Light Brown
FRC0413PC	13mm Syringe Filter, 0.45 μ m Regenerated Cellulose, Dark Brown
FAC0213PC	13mm Syringe Filter, 0.2 μ m Cellulose Acetate, Light Orange
FAC0413PC	13mm Syringe Filter, 0.45 μ m Cellulose Acetate, Dark Orange
FPS0213PC	13mm Syringe Filter, 0.2 μ m Polyethersulfone, Light Purple
FPS0413PC	13mm Syringe Filter, 0.45 μ m Polyethersulfone, Dark Purple
FGF1013PC	13mm Syringe Filter, 1.0 μ m Glass Fiber, Grey
FGF2013PC	13mm Syringe Filter, 2.0 μ m Glass Fiber, Grey
FGF5013PC	13mm Syringe Filter, 5.0 μ m Glass Fiber, Grey

13mm Syringe Filters - Mini Tip

Provide extremely low dead volume of less than 10 μ L, and are available in 0.2 μ m and 0.45 μ m pore sizes. Autoclavable.

Case Pack - 500 pieces

Mini Tip vs. Standard Tip



Cat. No.	Description
FEC0213PF	13mm Syringe Filter - Mini Tip, 0.2 μ m Mixed Esters Cellulose, Light Yellow
FEC0413PF	13mm Syringe Filter - Mini Tip, 0.45 μ m Mixed Esters Cellulose, Dark Yellow
FPV0213PF	13mm Syringe Filter - Mini Tip, 0.2 μ m PVDF, Light Red
FPV0413PF	13mm Syringe Filter - Mini Tip, 0.45 μ m PVDF, Dark Red
FNY0213PF	13mm Syringe Filter - Mini Tip, 0.2 μ m Nylon, Light Green
FNY0413PF	13mm Syringe Filter - Mini Tip, 0.45 μ m Nylon, Dark Green
FPT0213PF	13mm Syringe Filter - Mini Tip, 0.2 μ m PTFE, Light Blue
FPT0413PF	13mm Syringe Filter - Mini Tip, 0.45 μ m PTFE, Dark Blue
FPP0213PF	13mm Syringe Filter - Mini Tip, 0.2 μ m Polypropylene, Transparent
FPP0413PF	13mm Syringe Filter - Mini Tip, 0.45 μ m Polypropylene, White
FRC0213PF	13mm Syringe Filter - Mini Tip, 0.2 μ m Regenerated Cellulose, Light Brown
FRC0413PF	13mm Syringe Filter - Mini Tip, 0.45 μ m Regenerated Cellulose, Dark Brown
FAC0213PF	13mm Syringe Filter - Mini Tip, 0.2 μ m Cellulose Acetate, Light Orange
FAC0413PF	13mm Syringe Filter - Mini Tip, 0.45 μ m Cellulose Acetate, Dark Orange
FPS0213PF	13mm Syringe Filter - Mini Tip, 0.2 μ m Polyethersulfone, Light Purple
FPS0413PF	13mm Syringe Filter - Mini Tip, 0.45 μ m Polyethersulfone, Dark Purple
FGF1013PF	13mm Syringe Filter - Mini Tip, 1.0 μ m Glass Fiber, Grey
FGF2013PF	13mm Syringe Filter - Mini Tip, 2.0 μ m Glass Fiber, Grey
FGF5013PF	13mm Syringe Filter - Mini Tip, 5.0 μ m Glass Fiber, Grey

4mm, 13mm, and 25mm Syringe Filters

25mm Syringe Filters

Available in 0.2 μ m and 0.45 μ m pore size. Autoclavable.

Case Pack - 100 pieces



Cat. No.	Description
FEC0225PC	25mm Syringe Filter, 0.2 μ m Mixed Esters Cellulose, Light Yellow
FEC0425PC	25mm Syringe Filter, 0.45 μ m Mixed Esters Cellulose, Dark Yellow
FPV0225PC	25mm Syringe Filter, 0.2 μ m PVDF, Light Red
FPV0425PC	25mm Syringe Filter, 0.45 μ m PVDF, Dark Red
FNY0225PC	25mm Syringe Filter, 0.2 μ m Nylon, Light Green
FNY0425PC	25mm Syringe Filter, 0.45 μ m Nylon, Dark Green
FPT0225PC	25mm Syringe Filter, 0.2 μ m PTFE, Light Blue
FPT0425PC	25mm Syringe Filter, 0.45 μ m PTFE, Dark Blue
FPP0225PC	25mm Syringe Filter, 0.2 μ m Polypropylene, Transparent
FPP0425PC	25mm Syringe Filter, 0.45 μ m Polypropylene, White
FRC0225PC	25mm Syringe Filter, 0.2 μ m Regenerated Cellulose, Light Brown
FRC0425PC	25mm Syringe Filter, 0.45 μ m Regenerated Cellulose, Dark Brown
FAC0225PC	25mm Syringe Filter, 0.2 μ m Cellulose Acetate, Light Orange
FAC0425PC	25mm Syringe Filter, 0.45 μ m Cellulose Acetate, Dark Orange
FPS0225PC	25mm Syringe Filter, 0.2 μ m Polyethersulfone, Light Purple
FPS0425PC	25mm Syringe Filter, 0.45 μ m Polyethersulfone, Dark Purple
FGF1025PC	25mm Syringe Filter, 1.0 μ m Glass Fiber, Grey
FGF2025PC	25mm Syringe Filter, 2.0 μ m Glass Fiber, Grey
FGF5025PC	25mm Syringe Filter, 5.0 μ m Glass Fiber, Grey

25mm Syringe Filters with 1.0 μ m Glass Fiber

Glass fiber membranes have fast filtration flow, eliminate sample contamination, and have good chemical compatibility. Autoclavable.

Case Pack - 100 pieces

Cat. No.	Description
FEC0225GC	25mm Syringe Filter - Glass Fiber 1.0 μ m, 0.2 μ m Mixed Esters Cellulose, Light Yellow
FEC0425GC	25mm Syringe Filter - Glass Fiber 1.0 μ m, 0.45 μ m Mixed Esters Cellulose, Dark Yellow
FPV0225GC	25mm Syringe Filter - Glass Fiber 1.0 μ m, 0.2 μ m PVDF, Light Red
FPV0425GC	25mm Syringe Filter - Glass Fiber 1.0 μ m, 0.45 μ m PVDF, Dark Red
FNY0225GC	25mm Syringe Filter - Glass Fiber 1.0 μ m, 0.2 μ m Nylon, Light Green
FNY0425GC	25mm Syringe Filter - Glass Fiber 1.0 μ m, 0.45 μ m Nylon, Dark Green
FPT0225GC	25mm Syringe Filter - Glass Fiber 1.0 μ m, 0.2 μ m PTFE, Light Blue
FPT0425GC	25mm Syringe Filter - Glass Fiber 1.0 μ m, 0.45 μ m PTFE, Dark Blue
FPP0225GC	25mm Syringe Filter - Glass Fiber 1.0 μ m, 0.2 μ m Polypropylene, Transparent
FPP0425GC	25mm Syringe Filter - Glass Fiber 1.0 μ m, 0.45 μ m Polypropylene, White
FRC0225GC	25mm Syringe Filter - Glass Fiber 1.0 μ m, 0.2 μ m Regenerated Cellulose, Light Brown
FRC0425GC	25mm Syringe Filter - Glass Fiber 1.0 μ m, 0.45 μ m Regenerated Cellulose, Dark Brown
FAC0225GC	25mm Syringe Filter - Glass Fiber 1.0 μ m, 0.2 μ m Cellulose Acetate, Light Orange
FAC0425GC	25mm Syringe Filter - Glass Fiber 1.0 μ m, 0.45 μ m Cellulose Acetate, Dark Orange
FPS0225GC	25mm Syringe Filter - Glass Fiber 1.0 μ m, 0.2 μ m Polyethersulfone, Light Purple
FPS0425GC	25mm Syringe Filter - Glass Fiber 1.0 μ m, 0.45 μ m Polyethersulfone, Dark Purple

4mm, 13mm, and 25mm Syringe Filters

25mm Robotic Syringe Filters

Developed specifically for automated sample filtration systems. Autoclavable.



Case Pack - 1000 pieces

Cat. No.	Description
FEC0225RC	25mm Robotic Filter, 0.2µm Mixed Esters Cellulose, Light Yellow
FEC0425RC	25mm Robotic Filter, 0.45µm Mixed Esters Cellulose, Dark Yellow
FPV0225RC	25mm Robotic Filter, 0.2µm PVDF, Light Red
FPV0425RC	25mm Robotic Filter, 0.45µm PVDF, Dark Red
FNY0225RC	25mm Robotic Filter, 0.2µm Nylon, Light Green
FNY0425RC	25mm Robotic Filter, 0.45µm Nylon, Dark Green
FPT0225RC	25mm Robotic Filter, 0.2µm PTFE, Light Blue
FPT0425RC	25mm Robotic Filter, 0.45µm PTFE, Dark Blue
FPP0225RC	25mm Robotic Filter, 0.2µm Polypropylene, Transparent
FPP0425RC	25mm Robotic Filter, 0.45µm Polypropylene, White
FRC0225RC	25mm Robotic Filter, 0.2µm Regenerated Cellulose, Light Brown
FRC0425RC	25mm Robotic Filter, 0.45µm Regenerated Cellulose, Dark Brown
FAC0225RC	25mm Robotic Filter, 0.2µm Cellulose Acetate, Light Orange
FAC0425RC	25mm Robotic Filter, 0.45µm Cellulose Acetate, Dark Orange
FPS0225RC	25mm Robotic Filter, 0.2µm Polyethersulfone, Light Purple
FPS0425RC	25mm Robotic Filter, 0.45µm Polyethersulfone, Dark Purple
FGF1025RC	25mm Robotic Filter, 1.0µm Glass Fiber, Grey
FGF2025RC	25mm Robotic Filter, 2.0µm Glass Fiber, Grey
FGF5025RC	25mm Robotic Filter, 5.0µm Glass Fiber, Grey

25mm Robotic Syringe Filters with 1.0µm Glass Fiber

Case Pack - 1000 pieces

Cat. No.	Description
FEC0225GRC	25mm Robot Filter - Glass Fiber 1.0µm, 0.2µm Mixed Esters Cellulose, Light Yellow
FEC0425GRC	25mm Robot Filter - Glass Fiber 1.0µm, 0.45µm Mixed Esters Cellulose, Dark Yellow
FPV0225GRC	25mm Robot Filter - Glass Fiber 1.0µm, 0.2µm PVDF, Light Red
FPV0425GRC	25mm Robot Filter - Glass Fiber 1.0µm, 0.45µm PVDF, Dark Red
FNY0225GRC	25mm Robot Filter - Glass Fiber 1.0µm, 0.2µm Nylon, Light Green
FNY0425GRC	25mm Robot Filter - Glass Fiber 1.0µm, 0.45µm Nylon, Dark Green
FPT0225GRC	25mm Robot Filter - Glass Fiber 1.0µm, 0.2µm PTFE, Light Blue
FPT0425GRC	25mm Robot Filter - Glass Fiber 1.0µm, 0.45µm PTFE, Dark Blue
FPP0225GRC	25mm Robot Filter - Glass Fiber 1.0µm, 0.2µm Polypropylene, Transparent
FPP0425GRC	25mm Robot Filter - Glass Fiber 1.0µm, 0.45µm Polypropylene, White
FRC0225GRC	25mm Robot Filter - Glass Fiber 1.0µm, 0.2µm Regenerated Cellulose, Light Brown
FRC0425GRC	25mm Robot Filter - Glass Fiber 1.0µm, 0.45µm Regenerated Cellulose, Dark Brown
FAC0225GRC	25mm Robot Filter - Glass Fiber 1.0µm, 0.2µm Cellulose Acetate, Light Orange
FAC0425GRC	25mm Robot Filter - Glass Fiber 1.0µm, 0.45µm Cellulose Acetate, Dark Orange
FPS0225GRC	25mm Robot Filter - Glass Fiber 1.0µm, 0.2µm Polyethersulfone, Light Purple
FPS0425GRC	25mm Robot Filter - Glass Fiber 1.0µm, 0.45µm Polyethersulfone, Dark Purple

4mm, 13mm, and 25mm Syringe Filters

Standard Filter



Automatic Filter

25mm Automatic Syringe Filters

Suitable for manual and automated filtrations. Ideal for sample volumes up to 10mL. Autoclavable.

Case Pack - 1000 pieces

Cat. No.	Description
FEC0225AC	25mm Automatic Filter, 0.2µm Mixed Esters Cellulose, Light Yellow
FEC0425AC	25mm Automatic Filter, 0.45µm Mixed Esters Cellulose, Dark Yellow
FPV0225AC	25mm Automatic Filter, 0.2µm PVDF, Light Red
FPV0425AC	25mm Automatic Filter, 0.45µm PVDF, Dark Red
FNY0225AC	25mm Automatic Filter, 0.2µm Nylon, Light Green
FNY0425AC	25mm Automatic Filter, 0.45µm Nylon, Dark Green
FPT0225AC	25mm Automatic Filter, 0.2µm PTFE, Light Blue
FPT0425AC	25mm Automatic Filter, 0.45µm PTFE, Dark Blue
FPP0225AC	25mm Automatic Filter, 0.2µm Polypropylene, Transparent
FPP0425AC	25mm Automatic Filter, 0.45µm Polypropylene, White
FRC0225AC	25mm Automatic Filter, 0.2µm Regenerated Cellulose, Light Brown
FRC0425AC	25mm Automatic Filter, 0.45µm Regenerated Cellulose, Dark Brown
FAC0225AC	25mm Automatic Filter, 0.2µm Cellulose Acetate, Light Orange
FAC0425AC	25mm Automatic Filter, 0.45µm Cellulose Acetate, Dark Orange
FPS0225AC	25mm Automatic Filter, 0.2µm Polyethersulfone, Light Purple
FPS0425AC	25mm Automatic Filter, 0.45µm Polyethersulfone, Dark Purple
FGF1025AC	25mm Automatic Filter, 1.0µm Glass Fiber, Grey
FGF2025AC	25mm Automatic Filter, 2.0µm Glass Fiber, Grey
FGF5025AC	25mm Automatic Filter, 5.0µm Glass Fiber, Grey

25mm Automatic Syringe Filters with 1.0µm Glass Fiber

Case Pack - 1000 pieces

Cat. No.	Description
FEC0225GAC	25mm Automatic Filter - Glass Fiber 1.0µm, 0.2µm Mixed Esters Cellulose, Light Yellow
FEC0425GAC	25mm Automatic Filter - Glass Fiber 1.0µm, 0.45µm Mixed Esters Cellulose, Dark Yellow
FPV0225GAC	25mm Automatic Filter - Glass Fiber 1.0µm, 0.2µm PVDF, Light Red
FPV0425GAC	25mm Automatic Filter - Glass Fiber 1.0µm, 0.45µm PVDF, Dark Red
FNY0225GAC	25mm Automatic Filter - Glass Fiber 1.0µm, 0.2µm Nylon, Light Green
FNY0425GAC	25mm Automatic Filter - Glass Fiber 1.0µm, 0.45µm Nylon, Dark Green
FPT0225GAC	25mm Automatic Filter - Glass Fiber 1.0µm, 0.2µm PTFE, Light Blue
FPT0425GAC	25mm Automatic Filter - Glass Fiber 1.0µm, 0.45µm PTFE, Dark Blue
FPP0225GAC	25mm Automatic Filter - Glass Fiber 1.0µm, 0.2µm Polypropylene, Transparent
FPP0425GAC	25mm Automatic Filter - Glass Fiber 1.0µm, 0.45µm Polypropylene, White
FRC0225GAC	25mm Automatic Filter - Glass Fiber 1.0µm, 0.2µm Regenerated Cellulose, Light Brown
FRC0425GAC	25mm Automatic Filter - Glass Fiber 1.0µm, 0.45µm Regenerated Cellulose, Dark Brown
FAC0225GAC	25mm Automatic Filter - Glass Fiber 1.0µm, 0.2µm Cellulose Acetate, Light Orange
FAC0425GAC	25mm Automatic Filter - Glass Fiber 1.0µm, 0.45µm Cellulose Acetate, Dark Orange
FPS0225GAC	25mm Automatic Filter - Glass Fiber 1.0µm, 0.2µm Polyethersulfone, Light Purple
FPS0425GAC	25mm Automatic Filter - Glass Fiber 1.0µm, 0.45µm Polyethersulfone, Dark Purple

Membrane Filters



All Finneran Products Are Certified

CHEMICAL COMPATIBILITY

PROUCT	Strong Acids	Dilute Acids	Aliphatic Alcohol	Aldehydes	Bases	Esters	Aliphatic Hydroc.	Aromatic Hydroc.	Halogen Hydroc.	CETONES	Strong Oxidants
PVDF	N	R	R	R	N	L	R	R	R	N	L
PTFE	R	R	R	R	R	R	R	R	R	R	R
Nylon	N	L	R	L	L	R	R	L	L	R	N
Mixed Esters Cellulose	N	R	L	L	N	N	R	R	L	N	L
Polypropylene	R	R	R	L	R	R	R	N	L	R	R
Cellulose Acetate	N	L	L	L	N	N	R	R	N	L	L
Regenerated Cellulose	N	R	R	L	L	R	R	R	R	R	L
Polyethersulfone	N	R	L	L	R	L	R	R	N	L	L
Glass Fiber	R	R	R	R	R	R	R	R	R	R	R

R: Recommended, L: Limited Compatibility, N: Not recommended

TECHNICAL CHARACTERISTICS

PRODUCT	Minimum Bubble Point- Water	Minimum Water flow rate (at 0.7 bar, 25°C)
PVDF 0,2µm	260 kPa	2 ml/min/cm ²
PVDF 0,45µm	170 kPa	10 ml/min/cm ²
PTFE 0,2µm	110 kPa	6 ml/min/cm ²
PTFE 0,45µm	60 kPa	15 ml/min/cm ²
Nylon 0,2µm	350 kPa	5 ml/min/cm ²
Nylon 0,45µm	210 kPa	10 ml/min/cm ²
Mixed Esters Cellulose 0,2µm	380 kPa	15 ml/min/cm ²
Mixed Esters Cellulose 0,45µm	260 kPa	25 ml/min/cm ²
Polypropylene 0,2µm	280 kPa	8 ml/min/cm ²
Polypropylene 0,45µm	210 kPa	20 ml/min/cm ²
Cellulose Acetate 0,2µm	350 kPa	10 ml/min/cm ²
Cellulose Acetate 0,45µm	270 kPa	20 ml/min/cm ²
Regenerated Cellulose 0,2µm	250 kPa	10 ml/min/cm ²
Regenerated Cellulose 0,45µm	200 kPa	15 ml/min/cm ²
Polyethersulfone 0,2µm	360 kPa	15 ml/min/cm ²
Polyethersulfone 0,45µm	280 kPa	25 ml/min/cm ²
Glass Fiber 1.0µm	N.A.	>80 ml/min/cm ²
Glass Fiber 2.0µm	N.A.	>95 ml/min/cm ²
Glass Fiber 5.0µm	N.A.	>105 ml/min/cm ²

Membrane Filters

13mm Membrane Filters

Case Pack - 100 pieces

Cat. No.	Description
FEC0213MC	13mm Membrane Filter, 0.2µm Mixed Esters Cellulose
FEC0413MC	13mm Membrane Filter, 0.45µm Mixed Esters Cellulose
FPV0213MC	13mm Membrane Filter, 0.2µm PVDF
FPV0413MC	13mm Membrane Filter, 0.45µm PVDF
FNY0213MC	13mm Membrane Filter, 0.2µm Nylon
FNY0413MC	13mm Membrane Filter, 0.45µm Nylon
FPT0213MC	13mm Membrane Filter, 0.2µm PTFE
FPT0413MC	13mm Membrane Filter, 0.45µm PTFE
FPP0213MC	13mm Membrane Filter, 0.2µm Polypropylene
FPP0413MC	13mm Membrane Filter, 0.45µm Polypropylene
FRC0213MC	13mm Membrane Filter, 0.2µm Regenerated Cellulose
FRC0413MC	13mm Membrane Filter, 0.45µm Regenerated Cellulose
FAC0213MC	13mm Membrane Filter, 0.2µm Cellulose Acetate
FAC0413MC	13mm Membrane Filter, 0.45µm Cellulose Acetate
FPS0213MC	13mm Membrane Filter, 0.2µm Polyethersulfone
FPS0413MC	13mm Membrane Filter, 0.45µm Polyethersulfone
FGF1013MC	13mm Membrane Filter, 1.0µm Glass Fiber
FGF2013MC	13mm Membrane Filter, 2.0µm Glass Fiber
FGF5013MC	13mm Membrane Filter, 5.0µm Glass Fiber

25mm Membrane Filters

Case Pack - 50 pieces

Cat. No.	Description
FEC0225MD	25mm Membrane Filter, 0.2µm Mixed Esters Cellulose
FEC0425MD	25mm Membrane Filter, 0.45µm Mixed Esters Cellulose
FPV0225MD	25mm Membrane Filter, 0.2µm PVDF
FPV0425MD	25mm Membrane Filter, 0.45µm PVDF
FNY0225MD	25mm Membrane Filter, 0.2µm Nylon
FNY0425MD	25mm Membrane Filter, 0.45µm Nylon
FPT0225MD	25mm Membrane Filter, 0.2µm PTFE
FPT0425MD	25mm Membrane Filter, 0.45µm PTFE
FPP0225MD	25mm Membrane Filter, 0.2µm Polypropylene
FPP0425MD	25mm Membrane Filter, 0.45µm Polypropylene
FRC0225MD	25mm Membrane Filter, 0.2µm Regenerated Cellulose
FRC0425MD	25mm Membrane Filter, 0.45µm Regenerated Cellulose
FAC0225MD	25mm Membrane Filter, 0.2µm Cellulose Acetate
FAC0425MD	25mm Membrane Filter, 0.45µm Cellulose Acetate
FPS0225MD	25mm Membrane Filter, 0.2µm Polyethersulfone
FPS0425MD	25mm Membrane Filter, 0.45µm Polyethersulfone
FGF1025MD	25mm Membrane Filter, 1.0µm Glass Fiber
FGF2025MD	25mm Membrane Filter, 2.0µm Glass Fiber
FGF5025MD	25mm Membrane Filter, 5.0µm Glass Fiber

Membrane Filters

37mm Membrane Filter

Case Pack - 50 pieces

Cat. No.	Description
FEC0237MD	37mm Membrane Filter, 0.2µm Mixed Esters Cellulose
FEC0437MD	37mm Membrane Filter, 0.45µm Mixed Esters Cellulose
FPV0237MD	37mm Membrane Filter, 0.2µm PVDF
FPV0437MD	37mm Membrane Filter, 0.45µm PVDF
FNY0237MD	37mm Membrane Filter, 0.2µm Nylon
FNY0437MD	37mm Membrane Filter, 0.45µm Nylon
FPT0237MD	37mm Membrane Filter, 0.2µm PTFE
FPT0437MD	37mm Membrane Filter, 0.45µm PTFE
FPP0237MD	37mm Membrane Filter, 0.2µm Polypropylene
FPP0437MD	37mm Membrane Filter, 0.45µm Polypropylene
FRC0237MD	37mm Membrane Filter, 0.2µm Regenerated Cellulose
FRC0437MD	37mm Membrane Filter, 0.45µm Regenerated Cellulose
FAC0237MD	37mm Membrane Filter, 0.2µm Cellulose Acetate
FAC0437MD	37mm Membrane Filter, 0.45µm Cellulose Acetate
FPS0237MD	37mm Membrane Filter, 0.2µm Polyethersulfone
FPS0437MD	37mm Membrane Filter, 0.45µm Polyethersulfone
FGF1037MD	37mm Membrane Filter, 1.0µm Glass Fiber (25 pieces)
FGF2037MD	37mm Membrane Filter, 2.0µm Glass Fiber (25 pieces)
FGF5037MD	37mm Membrane Filter, 5.0µm Glass Fiber (25 pieces)

47mm Membrane Filters

Case Pack - 50 pieces

Cat. No.	Description
FEC0247MD	47mm Membrane Filter, 0.2µm Mixed Esters Cellulose
FEC0447MD	47mm Membrane Filter, 0.45µm Mixed Esters Cellulose
FPV0247MD	47mm Membrane Filter, 0.2µm PVDF
FPV0447MD	47mm Membrane Filter, 0.45µm PVDF
FNY0247MD	47mm Membrane Filter, 0.2µm Nylon
FNY0447MD	47mm Membrane Filter, 0.45µm Nylon
FPT0247MD	47mm Membrane Filter, 0.2µm PTFE
FPT0447MD	47mm Membrane Filter, 0.45µm PTFE
FPP0247MD	47mm Membrane Filter, 0.2µm Polypropylene
FPP0447MD	47mm Membrane Filter, 0.45µm Polypropylene
FRC0247MD	47mm Membrane Filter, 0.2µm Regenerated Cellulose
FRC0447MD	47mm Membrane Filter, 0.45µm Regenerated Cellulose
FAC0247MD	47mm Membrane Filter, 0.2µm Cellulose Acetate
FAC0447MD	47mm Membrane Filter, 0.45µm Cellulose Acetate
FPS0247MD	47mm Membrane Filter, 0.2µm Polyethersulfone
FPS0447MD	47mm Membrane Filter, 0.45µm Polyethersulfone
FGF1047MD	47mm Membrane Filter, 1.0µm Glass Fiber (25 pieces)
FGF2047MD	47mm Membrane Filter, 2.0µm Glass Fiber (25 pieces)
FGF5047MD	47mm Membrane Filter, 5.0µm Glass Fiber (25 pieces)

SPE Cartridges

All Finneran Products Are Certified



Finneran Solid Phase Extraction (SPE) cartridges provide a fast and efficient sample clean-up and concentration prior to analysis through GC, HPLC, and/or other instrument methods. SPE method concentrates and purifies analytes from solution by absorption onto a disposable solid phase cartridge, followed by elution of the analyte with a solvent appropriate for instrument analysis. Finneran SPE cartridges consist of molded high purity polypropylene bodies with two 20µm polyethylene frits that contain the packing material. The cartridges are designed for manual and automated uses. All of our SPE cartridges are equipped with male Luer-tips to permit the use with multi-position vacuum manifolds.

SPE cartridges are simple to use and allow four-step sample preparation: conditioning, sample application, wash and elution.

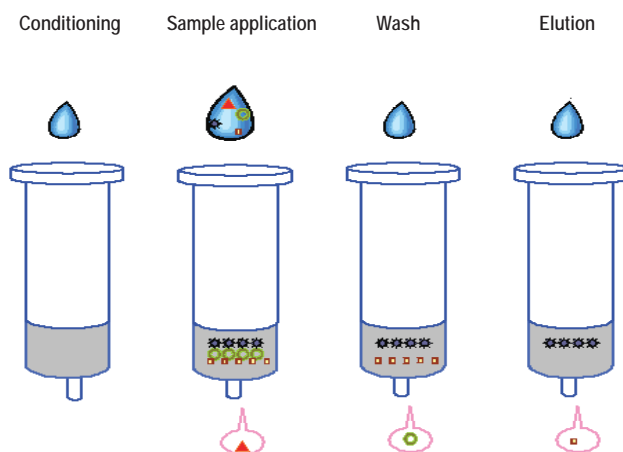

SPE products are manufactured in compliance with ISO 9001 and technical procedures and tested according to international standards of ISO 17025. The manufacturing methods guarantee the highest quality of products. The controlled weighing system, for each functional group dosage, assures high accuracy results from cartridge to cartridge with minimal variability. Samples and raw data of all SPE cartridge batches are stored for five years from production for reference.

Finneran SPE cartridges are available in four sizes (1, 3, 6, and 12mL) and different packing/phase materials (C2, C4, C8, C18, SI, CN, NH2, DIOL, Phenyl, Florisil®, SAX and SCX). Sorbent weights range from 100mg to 1g.

SPE Cartridges

GENERAL EXTRACTION PROCEDURES

Reversed-phase: Packing is composed of a silica backbone bonded with hydrocarbon chains. It is used to isolate relatively non-polar compounds from a polar matrix.

Conditioning	Sample application	Wash	Elution
Rinse packing bed with 3 - 5ml of methanol followed by 3 - 5ml of water or buffer (do not let packing bed dry before adding sample).	Apply sample solution to the top of the packing bed. Push or draw the sample through the bed at a flow rate of 1 - 5ml/min. Collect sample for analysis if desired compound has passed through the packing bed without being retained.	If the desired compound was retained, wash off any weakly retained interfering compound(s) with a polar solvent.	Elute desired compound with 1 - 2ml of a non-polar solvent and collect for analysis.

Normal-phase: Packing is composed of a silica backbone bonded with carbon chains containing polar functional groups. It is used to isolate polar compounds from a non-polar matrix.

Conditioning	Sample application	Wash	Elution
Rinse packing bed with 3 - 5ml of non-polar solvent (do not let packing bed dry before adding sample).	Apply sample solution to the top of the packing bed. Push or draw the sample through the bed at a flow rate of 1 - 5ml/min. Collect sample for analysis if desired compound has passed through the packing bed without being retained.	If the desired compound was retained, wash off any weakly retained interfering compound(s) with a non-polar solvent.	Elute desired compound with 1 - 2ml of a polar solvent and collect for analysis.

Ion-exchange: Packing is composed of different materials backbone bonded with carbon chains terminated by a negatively or positively charged functional groups. It is used to isolate charged or potentially charged compounds.

Conditioning	Sample application	Wash	Elution
Rinse packing bed with 3 - 5ml of de-ionized water or low ionic strength buffer (e.g. 0.0001M - 0.01M).	Apply sample to the top of the packing bed. Push or draw the sample through the bed at a flow rate of 1 - 2ml/min. Collect sample for analysis if desired compound has passed through the packing bed without being retained.	If the desired compound was retained, wash off any weakly retained interfering compound(s) with de-ionized water or low strength buffer.	Elute desired compound with 1 - 5ml of a high salt concentration solution (e.g. 0.1M - 0.5M) or change elution buffer pH such that the sample compound is no longer ionized and collect for analysis.

SPE Cartridges

FUNCTIONAL GROUPS

C8 - Octyl Bonded, Endcapped Silica

Average Particle Size: 50 μ m, Pore Size: 60Å

Retention mechanism: Reversed phase. Hydrophobic phase.

Applications: For reversed phase extraction of non-polar to moderately polar compounds, such as antibiotics, barbiturates, benzodiazepines, caffeine, drugs, dyes, essential oils, fat soluble vitamins, fungicides, herbicides, pesticides, hydrocarbons, parabens, phenols, phthalate esters, steroids, surfactants, theophylline, and water soluble vitamins.

Application Examples: Extraction of Alkylsulfonate Surfactants in Water, Extraction of Aldicarb Residues from Ground Water, Extraction of Anionic Surfactants in Soil.

C18 - Octadecyl Bonded, Endcapped Silica

Average Particle Size: 50 μ m, Pore Size: 60Å

Retention mechanism: Reversed phase. One of the most Hydrophobic phases.

Applications: For reversed phase extraction of nonpolar to moderately polar compounds, such as antibiotics, barbiturates, benzodiazepines, caffeine, drugs, dyes, essential oils, fat soluble vitamins, fungicides, herbicides, pesticides, hydrocarbons, parabens, phenols, phthalate esters, steroids, surfactants, theophylline, and water soluble vitamins.

Application Examples: Extraction of Catecholamines from Urine, Extraction of Polyaromatic Hydrocarbons in Drinking Water, Extraction of Organo Chlorine pesticides from aqueous solutions.

Silica - Silica Gel with no bonded phase

Average Particle Size: 50 μ m, Pore Size: 60Å

Retention mechanism: Normal phase. Polar neutral phase.

Applications: For extraction of polar compounds, such as alcohols, aldehydes, amines, drugs, dyes, herbicides, pesticides, ketones, nitro compounds, organic acids, phenols, and steroids.

Application Examples: Extraction of Vitamin D from Serum, Extraction of Aflatoxins from Corn, Peanuts, and Peanut Butter, Extraction of Amine Antioxidant from motor oil.

CN - Cyanopropyl, Endcapped Silica

Average Particle Size: 50 μ m, Pore Size: 60Å

Retention mechanism: Normal phase.

Weak/moderate non-polar with aqueous matrix, or polar with non-polar organic matrix.

Applications: For reversed phase extraction of moderately polar compounds, normal phase extraction of polar compounds, such as aflatoxins, antibiotics, dyes, herbicides, pesticides, phenols, steroids. Weak cation exchange for carbohydrates and cationic compounds.

Application Examples: Organochlorine Pesticides in Water, Extraction of Paraquat and Diquat from aqueous solutions. Extraction of N-Nitrosamine (N-Nitrosopyrrolidine) from bacon.

SPE Cartridges

NH2 - Aminopropyl, Bonded Silica

Average Particle Size: 50 μ m, Pore Size: 60Å

Retention mechanism: Weak anion exchange with aqueous matrix, normal phase with non-polar organic matrix.

Applications: For normal phase extraction of polar compounds, weak anion exchange for carbohydrates, weak anions, and organic acids.

Application Examples: Extraction of Pyridonecarboxylic-Acid Antibacterials (PCAs) from fish tissue, Extraction of Lipids from serum and tissue, Extraction of Pyridonecarboxylic-Acid Antibacterials from fish tissue.

Diol, (Glyceroxypropylsilyl) Bonded Silica

Average Particle Size: 50 μ m, Pore Size: 60Å

Retention mechanism: Normal phase

Applications: For normal phase extraction of polar compounds, weak anion exchange for carbohydrates, weak anions, and organic acids.

Application Examples: Extraction of Antibiotics from Ointment, Extraction of Urinary Cortisol, Extraction of the herbicide Atrazine from Corn Oil.

Florisol[®], Magnesium Silicate

Average Particle Size: 60 μ m, Pore Size: 100Å and Average Particle Size: 100 μ m, Pore Size: 200Å

Retention mechanism: Normal phase application – polar slightly basic phase

Applications: For adsorption extraction of polar compounds, such as alcohols, aldehydes, amines, drugs, dyes, herbicides, pesticides, PCBs, ketones, nitro compounds, organic acids, phenols, and steroids.

Application Examples: Extraction of Polychlorinated Biphenyls (PCBs) from transformer Oil, Extraction of Pesticides from fish, Extraction of Carbofuran and Carboxin from cabbage.

SCX, Tosic Acid, Bonded Silica with Na⁺ counterion

Average Particle Size: 40 - 63 μ m, Pore Size: 60Å

Retention mechanism: Cation exchange

Applications: For strong cation exchange for cations, antibiotics, drugs, organic bases, amino acids, catecholamines, herbicides, nucleic acid bases, nucleosides, and surfactants. Exchange Capacity: 0.2meq/g.

Application Examples: Extraction of Methylimidazole from food, Extraction of Amino Acids in medical plant extracts, Extraction of Hydroxyatrazine Metabolites from water.

SPE Cartridges

SAX, Tetramethyl ammonium chloride

Average Particle Size: 40 - 63 μ m, Pore Size: 60Å

Retention mechanism: Anion exchange

Applications: For strong anion exchange for anions, organic acids, nucleic acids, nucleotides, and surfactants.
Capacity: 0.2meq/g.

Application Examples: Extraction of caffeine, Saccharin and Sodium benzoate in beverages (Diet cola), Extraction of Folic Acid in cabbage, Extraction of Methylmalonic Acid from serum or plasma.



1ml SPE Cartridge, 100mg Dosage

Cat. No.	Description	Qty
JGF01C1801	C18 Functional Group	100
JGF01C801	C8 Functional Group	100
JGF01CN01	CN Functional Group	100
JGF01SI01	Silica Functional Group	100
JGF01NH01	NH2 Functional Group	100
JGF01FL0160	Florisil® Functional Group (60/100)	100
JGF01FL01100	Florisil® Functional Group (100/200)	100
JGF01DI01	Diol Functional Group	100
JGF01SA01	SAX Functional Group	100
JGF01SC01	SCX Functional Group	100



3ml SPE Cartridge, 200mg Dosage

Cat. No.	Description	Qty
JGF03C1802	C18 Functional Group	50
JGF03C802	C8 Functional Group	50
JGF03CN02	CN Functional Group	50
JGF03SI02	Silica Functional Group	50
JGF03NH02	NH2 Functional Group	50
JGF03FL0260	Florisil® Functional Group (60/100)	50
JGF03FL02100	Florisil® Functional Group (100/200)	50
JGF03DI02	Diol Functional Group	50
JGF03SA02	SAX Functional Group	50
JGF03SC02	SCX Functional Group	50



3ml SPE Cartridge, 500mg Dosage

Cat. No.	Description	Qty
JGF03C1805	C18 Functional Group	50
JGF03C805	C8 Functional Group	50
JGF03CN05	CN Functional Group	50
JGF03SI05	Silica Functional Group	50
JGF03NH05	NH2 Functional Group	50
JGF03FL0560	Florisil® Functional Group (60/100)	50
JGF03FL05100	Florisil® Functional Group (100/200)	50
JGF03DI05	Diol Functional Group	50
JGF03SA05	SAX Functional Group	50
JGF03SC05	SCX Functional Group	50

SPE Cartridges



6ml SPE Cartridge, 500mg Dosage

Cat. No.	Description	Qty
JGF06C1805	C18 Functional Group	30
JGF06C805	C8 Functional Group	30
JGF06CN05	CN Functional Group	30
JGF06SI05	Silica Functional Group	30
JGF06NH05	NH2 Functional Group	30
JGF06FL0560	Florisil® Functional Group (60/100)	30
JGF06FL05100	Florisil® Functional Group (100/200)	30
JGF06DI05	Diol Functional Group	30
JGF06SA05	SAX Functional Group	30
JGF06SC05	SCX Functional Group	30



6ml SPE Cartridge, 1000mg Dosage

Cat. No.	Description	Qty
JGF06C1810	C18 Functional Group	30
JGF06C810	C8 Functional Group	30
JGF06CN10	CN Functional Group	30
JGF06SI10	Silica Functional Group	30
JGF06NH10	NH2 Functional Group	30
JGF06FL1060	Florisil® Functional Group (60/100)	30
JGF06FL10100	Florisil® Functional Group (100/200)	30
JGF06DI10	Diol Functional Group	30
JGF06SA10	SAX Functional Group	30
JGF06SC10	SCX Functional Group	30



12ml SPE Cartridge, 1000mg Dosage

Cat. No.	Description	Qty
JGF12C1810	C18 Functional Group	20
JGF12C810	C8 Functional Group	20
JGF12CN10	CN Functional Group	20
JGF12SI10	Silica Functional Group	20
JGF12NH10	NH2 Functional Group	20
JGF12FL1060	Florisil® Functional Group (60/100)	20
JGF12FL10100	Florisil® Functional Group (100/200)	20
JGF12DI10	Diol Functional Group	20
JGF12SA10	SAX Functional Group	20
JGF12SC10	SCX Functional Group	20

TECHNICAL INFORMATION OF J.G. FINNERAN'S QuEChERS

QuEChERS (Quick, Easy, Cheap, Effective, Rugged & Safe) offer a convenient and effective approach for determining pesticide residues in fruits, vegetables, and other foods.

The J.G. Finneran QuEChERS Extraction and Dispersive SPE Kits enable you to work with specific methods, including:

1. **European EN 15662 Method** - Foods and Plant Origin - Determination of Pesticide Residues using GC-MS and/or LC-MS/MS following Acetonitrile Extraction/Partitioning and Clean-up by Dispersive SPE - QuEChERS method.
2. **AOAC Official 2007.01 Method** - Pesticide Residues in Food by Acetonitrile Extraction and Partitioning with Magnesium Sulfate.
3. **Mini-multiresidue Method** - Method for the Analysis of Pesticide Residues in Low-Fat Products.

Our products make it simple to prepare your food samples for analysis with:

- High recoveries
- Accurate results
- High sample throughput
- Minimal solvent use
- Less labor
- Lower costs

We offer QuEChERS Extraction and Dispersive SPE products in a variety of standard sizes and formats.

- Extraction kits contain preweighed salts, so you can add them after the Acetonitrile Extraction step, protecting the integrity of your sample.
- Dispersive SPE kits are assembled in 2mL and 15mL sizes, they are preweighed and premixed with the right mix of salts and sorbents for your aliquot volume.

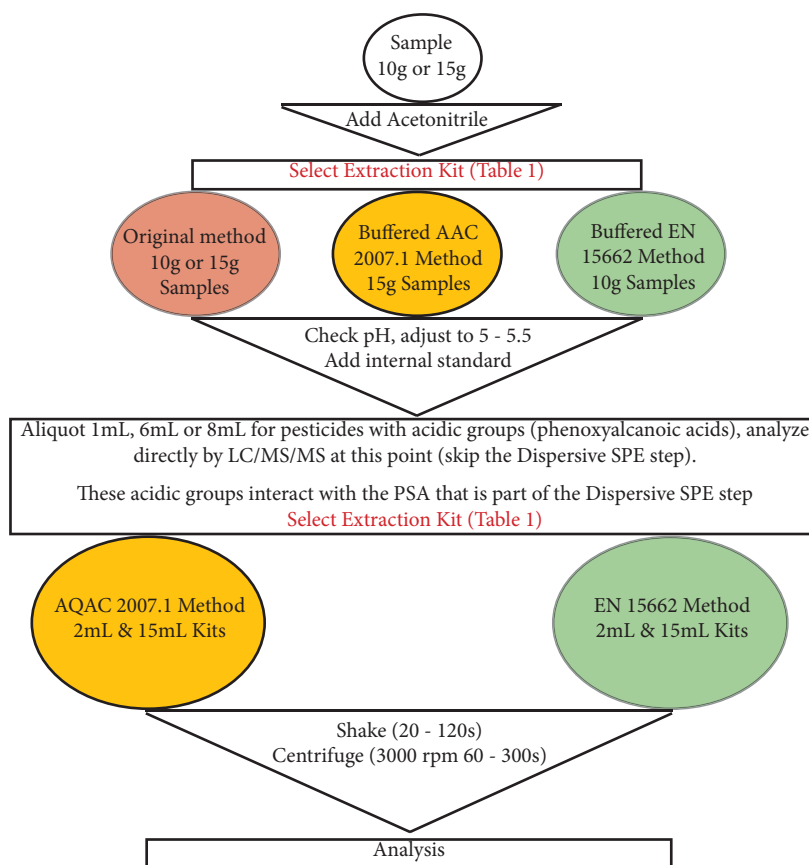

QuEChERS

PHASE 1: Extraction

Select the Extraction Kit depending on the type of food and the method to be used. Add solvent and salts to a small (10 or 15g) fruit or vegetable sample, enabling the extraction of the pesticide into an organic layer. (Table 1).

PHASE 1 Extraction Kit 50mL Centrifuge Tubes for Sample Extraction

Table 1

Part No.	Description	Qty.	Recommended Application
JGF00150P	4g MgSO ₄ , 1g NaCl, 1g trisodium citrate dihydrate, 0.5g disodium hydrogencitrate sesquihydrate	50	European EN-15662
JGF00250P	4g MgSO ₄ , 1g NaCl	50	Mini-Multiresidue (10g sample)
JGF00350P	6g MgSO ₄ , 1.5g NaCl, 1.5g sodium citrate dibasic, 0.75g disodium citrate dibasic sesquihydrate	50	
JGF00450P	6g MgSO ₄ , 1.5g NaOAc	50	AOAC 2007.01
JGF00550P	6g MgSO ₄ , 1.5g NaOAc, 0.75g disodium citrate sesquihydrate	50	
JGF00650P	6g MgSO ₄ , 1.5g NaCl	50	Mini-Multiresidue (15g sample)

Sachets

Part No.	Description	Qty.	Recommended Application
JGF00150S	4g MgSO ₄ , 1g NaCl, 1g trisodium citrate dihydrate, 0.5g disodium hydrogencitrate sesquihydrate	50	European EN-15662
JGF00250S	4g MgSO ₄ , 1g NaCl	50	Mini-Multiresidue (10g sample)
JGF00350S	6g MgSO ₄ , 1.5g NaCl, 1.5g sodium citrate dibasic, 0.75g disodium citrate dibasic sesquihydrate	50	
JGF00450S	6g MgSO ₄ , 1.5g NaOAc	50	AOAC 2007.01
JGF00550S	6g MgSO ₄ , 1.5g NaOAc, 0.75g disodium citrate sesquihydrate	50	
JGF00650S	6g MgSO ₄ , 1.5g NaCl	50	Mini-Multiresidue (15g sample)

PSA= Primary and secondary exchange material

GCB= Graphitized carbon blank



QuEChERS Sachets

QuEChERS

PHASE 2: Dispersive SPE Clean-up

Select the Extraction Kit depending on the type of food and the method to be used. One aliquot (*) of sample extract from Phase 1 is added to either the 2mL or 15mL centrifuge tube that contains a small quantity of SPE sorbent and MgSO₄.

PHASE 2 Dispersive SPE Kit

2mL Micro-centrifuge tubes

Part No.	Description	Qty.	*Aliquot (mL)	Recommended Application
JGF00102P	150mg MgSO ₄ , 25mg PSA	100	1	European EN-15662 Mini-Multiresidue
JGF00202P	150mg MgSO ₄ , 25mg PSA, 25mg C18	100	1	European EN-15662 Mini-Multiresidue
JGF00302P	150mg MgSO ₄ , 25mg PSA, 2.5mg GCB	100	1	European EN-15662 Mini-Multiresidue
JGF00402P	150mg MgSO ₄ , 25mg PSA, 7.5mg GCB	100	1	European EN-15662 Mini-Multiresidue
JGF00502P	150mg MgSO ₄ , 50mg PSA	100	1	AOAC 2007.01
JGF00602P	150mg MgSO ₄ , 50mg PSA, 50mg C18	100	1	AOAC 2007.01
JGF00702P	150mg MgSO ₄ , 50mg PSA, 50mg GCB	100	1	AOAC 2007.01
JGF00802P	150mg MgSO ₄ , 50mg PSA, 50mg C18, 50mg GCB	100	1	AOAC 2007.01
JGF00902P	150mg MgSO ₄ , 25mg C18	100	1	AOAC 2007.01

PHASE 2 Dispersive SPE Kit

15mL Centrifuge tubes

Part No.	Description	Qty.	*Aliquot (mL)	Recommended Application
JGF00115P	1200mg MgSO ₄ , 400mg PSA	50	8	AOAC 2007.01
JGF00215P	1200mg MgSO ₄ , 400mg PSA, 400mg C18	50	8	AOAC 2007.01
JGF00315P	1200mg MgSO ₄ , 400mg PSA, 400mg GCB	50	8	AOAC 2007.01
JGF00415P	1200mg MgSO ₄ , 400mg PSA, 400mg C18, 400mg GCB	50	8	AOAC 2007.01
JGF00515P	900mg MgSO ₄ , 150mg PSA	50	6	European EN-15662
JGF00615P	900mg MgSO ₄ , 150mg PSA, 15mg GCB	50	6	European EN-15662
JGF00715P	900mg MgSO ₄ , 150mg PSA, 45mg GCB	50	6	European EN-15662
JGF00815P	900mg MgSO ₄ , 150mg PSA, 150mg C18	50	6	European EN-15662
JGF00915P	900mg MgSO ₄ , 150mg PSA, 150mg GCB	50	6	European EN-15662
JGF01015P	900mg MgSO ₄ , 300mg PSA, 150mg C18	50	6	European EN-15662
JGF01115P	900mg MgSO ₄ , 150mg C18	50	6	AOAC 2007.01
JGF01215P	750mg MgSO ₄ , 250mg PSA, 250mg C18, 250mg GCB	50		

PHASE 2 Dispersive SPE Kit

Sachets

Part No.	Description	Qty.	Recommended Application
JGF00115S	1200mg MgSO ₄ , 400mg PSA	50	AOAC 2007.01
JGF00215S	1200mg MgSO ₄ , 400mg PSA, 400mg C18	50	AOAC 2007.01
JGF00315S	1200mg MgSO ₄ , 400mg PSA, 400mg GCB	50	AOAC 2007.01
JGF00415S	1200mg MgSO ₄ , 400mg PSA, 400mg C18, 400mg GCB	50	AOAC 2007.01
JGF00515S	900mg MgSO ₄ , 150mg PSA	50	European EN-15662
JGF00615S	900mg MgSO ₄ , 150mg PSA, 15mg GCB	50	European EN-15662
JGF00715S	900mg MgSO ₄ , 150mg PSA, 45mg GCB	50	European EN-15662
JGF00815S	900mg MgSO ₄ , 150mg PSA, 150mg C18	50	European EN-15662
JGF00915S	900mg MgSO ₄ , 150mg PSA, 150mg GCB	50	European EN-15662
JGF01015S	900mg MgSO ₄ , 300mg PSA, 150mg C18	50	European EN-15662
JGF01115S	900mg MgSO ₄ , 150mg C18	50	AOAC 2007.01
JGF01215S	750mg MgSO ₄ , 250mg PSA, 250mg C18, 250mg GCB	50	
JGF01315S	1200mg MgSO ₄ , 400mg PSA, 400mg C18, 60mg GCB	50	



QuEChERS

Selection Guide for Dispersive Kits. Phase 2

Methods



Types	Quantity per pack	EN 15662	AOAC 2007.1	Mini Multiresidue	Others
-------	-------------------	----------	-------------	-------------------	--------

General Fruits and Vegetables: Removes polar organic acids, some sugars and lipids

	100 tubes, 2mL	25mg PSA 150mg MgSO4 Part No. JGF00102P	50mg PSA 150mg MgSO4 Part No. JGF00502P	25mg PSA 150mg MgSO4 Part No. JGF00102P	
	50 tubes, 15mL	150mg PSA 900mg MgSO4 Part No. JGF00515P	400mg PSA 1200mg MgSO4 Part No. JGF00115P		



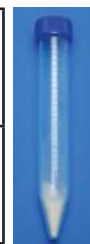

Fruits and Vegetables with Fats and Waxes: Removes polar organic acids, some sugars, more lipids and sterols

	100 tubes, 2mL	25mg PSA 25mg C18 150 mg MgSO4 Part No. JGF00202P	50mg PSA 50mg C18 150mg MgSO4 Part No. JGF00602P	25mg PSA 25mg C18 150mg MgSO4 Part No. JGF00202P	
	50 tubes, 15mL	150mg PSA 150mg C18 900mg MgSO4 Part No. JGF00815P	400mg PSA 400mg C18 1200mg MgSO4 Part No. JGF00215P		150mg C18 900mg MgSO4 Part No. JGF00815P



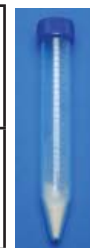

Pigmented Fruits and Vegetables: Removes polar organic acids, some sugars and lipids, and carotinoides and chlorophyll; not for use with planar pesticides

	100 tubes, 2mL	25mg PSA 2.5mg GCB 150mg MgSO4 Part No. JGF00302P	50mg PSA 50mg GCB 150mg MgSO4 Part No. JGF00702P	25mg PSA 2.5mg GCB 150mg MgSO4 Part No. JGF00302P	50mg PSA 50mg GCB 150mg MgSO4 Part No. JGF00702P
	50 tubes, 15mL	150mg PSA 15mg GCB 900mg MgSO4 Part No. JGF00615P	400mg PSA 400mg GCB 1200mg MgSO4 Part No. JGF00315P		





Highly Pigmented Fruits and Vegetables: Removes polar organic acids, some sugars and lipids, plus high levels of carotinoides and chlorophyll; not for use with planar pesticides

	100 tubes, 2mL	25mg PSA 7.5mg GCB 150mg MgSO4 Part No. JGF00402P	50mg PSA 50mg C18 50mg GCB 150mg MgSO4 Part No. JGF00802P	25mg PSA 7.5mg GCB 150mg MgSO4 Part No. JGF00402P	
	50 tubes, 15mL	150mg PSA 45mg GCB 900mg MgSO4 Part No. JGF00715P			300mg PSA 150mg GCB 900mg MgSO4 Part No. JGF00915P



Fruits and Vegetables with Pigments and Fats: Removes polar organic acids, some sugars and lipids, plus carotinoides and chlorophyll; not for use with planar pesticides

	100 tubes, 2mL		50mg PSA 50mg C18 50mg GCB 150mg MgSO4 Part No. JGF00802P		
	50 tubes, 15mL		400mg PSA 400mg C18 400mg GCB 1200mg MgSO4 Part No. JGF00415P		



Other Food Methods: Removes biological matrix interferences, including hydrophobic substances (fats, lipids) and proteins

	100 tubes, 2mL		25mg C18 150mg MgSO4 Part No. JGF00902P		
	50 tubes, 15mL		150mg C18 900mg MgSO4 Part No. JGF01115P		



VOA Vials - Open Top Closures and Septum

Finneran Products Certified For Science™



- Available in clear or amber borosilicate glass

- Choice of .125" or .100" PTFE/Silicone Septa

- Available in standard, precleaned or precleaned/certified in accordance with recommended E.P.A. Protocol

CLASS 1: (Standard) Containers are assembled with liner and closure without washing treatment.

CLASS 2: (Prcleaned) Containers are processed according to EPA recommended wash procedures. Washed with laboratory grade biodegradable, non-phosphate detergent, rinsed with ASTM Type I De-ionized water, oven dried, and assembled in a contaminate-free environment. The exterior of each case is labeled with a lot number. Each case contains a copy of wash "Standard Operating Procedure."

CLASS 3: (Certified) Containers are processed according to EPA recommended wash procedures. Washed with laboratory grade biodegradable, non-phosphate detergent, rinsed with ASTM Type I De-ionized water, oven dried and assembled in a contaminate-free environment. The exterior of each case is labeled with a lot number. Each case contains a "Certificate of Analysis."

An independent laboratory is used to certify the container's cleanliness, assuring impartial results.

Standard

Assembled with Open Top White Polypropylene Closures and Septum

20mL Vials - Class 1

Cat. No.	Description	Qty
9-107	20mL Clear, White Polypropylene 24-414mm Open Top Closure, 0.100" PTFE/Silicone Septa	72 Pack
9A-107	20mL Amber, White Polypropylene 24-414mm Open Top Closure, 0.100" PTFE/Silicone Septa	72 Pack
9-106	20mL Clear, White Polypropylene 24-414mm Open Top Closure, 0.125" PTFE/Silicone Septa	72 Pack
9A-106	20mL Amber, White Polypropylene 24-414mm Open Top Closure, 0.125" PTFE/Silicone Septa	72 Pack

40mL Vials - Class 1

Cat. No.	Description	Qty
9-105	40mL Clear, White Polypropylene 24-414mm Open Top Closure, 0.100" PTFE/Silicone Septa	72 Pack
9A-105	40mL Amber, White Polypropylene 24-414mm Open Top Closure, 0.100" PTFE/Silicone Septa	72 Pack
9-102	40mL Clear, White Polypropylene 24-414mm Open Top Closure, 0.125" PTFE/Silicone Septa	72 Pack
9A-102	40mL Amber, White Polypropylene 24-414mm Open Top Closure, 0.125" PTFE/Silicone Septa	72 Pack
9-103	40mL Clear, White Polypropylene 24-414mm Open Top Closure, 0.125" PTFE/Silicone Septa	100 Pack
9A-103	40mL Amber, White Polypropylene 24-414mm Open Top Closure, 0.125" PTFE/Silicone Septa	100 Pack
9-104	40mL Clear, White Polypropylene 24-414mm Open Top Closure, 0.125" PTFE/Silicone Septa	144 Pack
9A-104	40mL Amber, White Polypropylene 24-414mm Open Top Closure, 0.125" PTFE/Silicone Septa	144 Pack

Don't see what you are looking for?
Please contact us. Any combination of products is available.

VOA Vials - Open Top Closures and Septum

Standard

Assembled with Open Top White Polypropylene Closures and Septum

60mL Vials - Class 1

Cat. No.	Description	Qty
9-093	60mL Clear, White Polypropylene 24-414mm Open Top Closure, 0.100" PTFE/Silicone Septa	72 Pack
9A-093	60mL Amber, White Polypropylene 24-414mm Open Top Closure, 0.100" PTFE/Silicone Septa	72 Pack
9-112	60mL Clear, White Polypropylene 24-414mm Open Top Closure, 0.125" PTFE/Silicone Septa	72 Pack
9A-112	60mL Amber, White Polypropylene 24-414mm Open Top Closure, 0.125" PTFE/Silicone Septa	72 Pack

Precleaned

Assembled with Open Top White Polypropylene Closures and Septum

20mL Vials - Class 2

Cat. No.	Description	Qty
9-107-2	20mL Clear, White Polypropylene 24-414mm Open Top Closure, 0.100" PTFE/Silicone Septa	72 Pack
9A-107-2	20mL Amber, White Polypropylene 24-414mm Open Top Closure, 0.100" PTFE/Silicone Septa	72 Pack
9-106-2	20mL Clear, White Polypropylene 24-414mm Open Top Closure, 0.125" PTFE/Silicone Septa	72 Pack
9A-106-2	20mL Amber, White Polypropylene 24-414mm Open Top Closure, 0.125" PTFE/Silicone Septa	72 Pack

40mL Vials - Class 2

Cat. No.	Description	Qty
9-105-2	40mL Clear, White Polypropylene 24-414mm Open Top Closure, 0.100" PTFE/Silicone Septa	72 Pack
9A-105-2	40mL Amber, White Polypropylene 24-414mm Open Top Closure, 0.100" PTFE/Silicone Septa	72 Pack
9-102-2	40mL Clear, White Polypropylene 24-414mm Open Top Closure, 0.125" PTFE/Silicone Septa	72 Pack
9A-102-2	40mL Amber, White Polypropylene 24-414mm Open Top Closure, 0.125" PTFE/Silicone Septa	72 Pack
9-103-2	40mL Clear, White Polypropylene 24-414mm Open Top Closure, 0.125" PTFE/Silicone Septa	100 Pack
9A-103-2	40mL Amber, White Polypropylene 24-414mm Open Top Closure, 0.125" PTFE/Silicone Septa	100 Pack
9-104-2	40mL Clear, White Polypropylene 24-414mm Open Top Closure, 0.125" PTFE/Silicone Septa	144 Pack
9A-104-2	40mL Amber, White Polypropylene 24-414mm Open Top Closure, 0.125" PTFE/Silicone Septa	144 Pack

60mL Vials - Class 2

Cat. No.	Description	Qty
9-093-2	60mL Clear, White Polypropylene 24-414mm Open Top Closure, 0.100" PTFE/Silicone Septa	72 Pack
9A-093-2	60mL Amber, White Polypropylene 24-414mm Open Top Closure, 0.100" PTFE/Silicone Septa	72 Pack
9-112-2	60mL Clear, White Polypropylene 24-414mm Open Top Closure, 0.125" PTFE/Silicone Septa	72 Pack
9A-112-2	60mL Amber, White Polypropylene 24-414mm Open Top Closure, 0.125" PTFE/Silicone Septa	72 Pack

*Don't see what you are looking for?
Please contact us. Any combination of products is available.*

VOA Vials - Open Top Closures and Septum

Precleaned and Certified

Assembled with Open Top White Polypropylene Closures and Septum

20mL Vials - Class 3

Cat. No.	Description	Qty
9-107-3	20mL Clear, White Polypropylene 24-414mm Open Top Closure, 0.100" PTFE/Silicone Septa	72 Pack
9A-107-3	20mL Amber, White Polypropylene 24-414mm Open Top Closure, 0.100" PTFE/Silicone Septa	72 Pack
9-106-3	20mL Clear, White Polypropylene 24-414mm Open Top Closure, 0.125" PTFE/Silicone Septa	72 Pack
9A-106-3	20mL Amber, White Polypropylene 24-414mm Open Top Closure, 0.125" PTFE/Silicone Septa	72 Pack

40mL Vials - Class 3

Cat. No.	Description	Qty
9-105-3	40mL Clear, White Polypropylene 24-414mm Open Top Closure, 0.100" PTFE/Silicone Septa	72 Pack
9A-105-3	40mL Amber, White Polypropylene 24-414mm Open Top Closure, 0.100" PTFE/Silicone Septa	72 Pack
9-102-3	40mL Clear, White Polypropylene 24-414mm Open Top Closure, 0.125" PTFE/Silicone Septa	72 Pack
9A-102-3	40mL Amber, White Polypropylene 24-414mm Open Top Closure, 0.125" PTFE/Silicone Septa	72 Pack
9-103-3	40mL Clear, White Polypropylene 24-414mm Open Top Closure, 0.125" PTFE/Silicone Septa	100 Pack
9A-103-3	40mL Amber, White Polypropylene 24-414mm Open Top Closure, 0.125" PTFE/Silicone Septa	100 Pack
9-104-3	40mL Clear, White Polypropylene 24-414mm Open Top Closure, 0.125" PTFE/Silicone Septa	144 Pack
9A-104-3	40mL Amber, White Polypropylene 24-414mm Open Top Closure, 0.125" PTFE/Silicone Septa	144 Pack

60mL Vials - Class 3

Cat. No.	Description	Qty
9-093-3	60mL Clear, White Polypropylene 24-414mm Open Top Closure, 0.100" PTFE/Silicone Septa	72 Pack
9A-093-3	60mL Amber, White Polypropylene 24-414mm Open Top Closure, 0.100" PTFE/Silicone Septa	72 Pack
9-112-3	60mL Clear, White Polypropylene 24-414mm Open Top Closure, 0.125" PTFE/Silicone Septa	72 Pack
9A-112-3	60mL Amber, White Polypropylene 24-414mm Open Top Closure, 0.125" PTFE/Silicone Septa	72 Pack

Low Level TOC Vials - Cleaned and Certified (<10 ppb)

Cat. No.	Description	Qty
9-105-TOC	40mL TOC Certified Clear Vial, 24-414mm Open Top Gray Polypropylene Closure, 0.125" PTFE/Silicone Septa	72 Pack

*Don't see what you are looking for?
Please contact us. Any combination of products is available.*

VOA Vials - Open Top Closures with Patented Top Hat™ Septa

Finneran Products Certified For Science™



- Available in clear or amber borosilicate glass
- Assembled with the patented Top Hat™ Liner system
- Available in standard, precleaned or precleaned/certified in accordance with recommended E.P.A. Protocol

CLASS 1: (Standard) Containers are assembled with liner and closure without washing treatment.

CLASS 2: (Precleaned) Containers are processed according to EPA recommended wash procedures. Washed with laboratory grade biodegradable, non-phosphate detergent, rinsed with ASTM Type I De-ionized water, oven dried, and assembled in a contaminate-free environment. The exterior of each case is labeled with a lot number. Each case contains a copy of wash "Standard Operating Procedure."

CLASS 3: (Certified) Containers are processed according to EPA recommended wash procedures. Washed with laboratory grade biodegradable, non-phosphate detergent, rinsed with ASTM Type I De-ionized water, oven dried and assembled in a contaminate-free environment. The exterior of each case is labeled with a lot number. Each case contains a "Certificate of Analysis."

An independent laboratory is used to certify the container's cleanliness, assuring impartial results.

Standard

Assembled with Open Top Black Polypropylene Closures and Top Hat™ Septa

20mL Vials - Class 1

Cat. No.	Description	Qty
9-131	20mL Clear, Black Polypropylene 24-400mm Open Top Closure, 0.125" PTFE/Silicone Top Hat™ Septa	72 Pack
9A-131	20mL Amber, Black Polypropylene 24-400mm Open Top Closure, 0.125" PTFE/Silicone Top Hat™ Septa	72 Pack

40mL Vials - Class 1

Cat. No.	Description	Qty
9-130	40mL Clear, Black Polypropylene 24-400mm Open Top Closure, 0.125" PTFE/Silicone Top Hat™ Septa	72 Pack
9A-130	40mL Amber, Black Polypropylene 24-400mm Open Top Closure, 0.125" PTFE/Silicone Top Hat™ Septa	72 Pack

60mL Vials - Class 1

Cat. No.	Description	Qty
9-135	60mL Clear, Black Polypropylene 24-400mm Open Top Closure, 0.125" PTFE/Silicone Top Hat™ Septa	72 Pack
9A-135	60mL Amber, Black Polypropylene 24-400mm Open Top Closure, 0.125" PTFE/Silicone Top Hat™ Septa	72 Pack

Don't see what you are looking for?
Please contact us. Any combination of products is available.

VOA Vials - Open Top Closures with Patented Top Hat™ Septa

Precleaned

Assembled with Open Top Black Polypropylene Closures and Top Hat™ Septa

20mL Vials - Class 2

Cat. No.	Description	Qty
9-131-2	20mL Clear, Black Polypropylene 24-400mm Open Top Closure, 0.125" PTFE/Silicone Top Hat™ Septa	72 Pack
9A-131-2	20mL Amber, Black Polypropylene 24-400mm Open Top Closure, 0.125" PTFE/Silicone Top Hat™ Septa	72 Pack

40mL Vials - Class 2

Cat. No.	Description	Qty
9-130-2	40mL Clear, Black Polypropylene 24-400mm Open Top Closure, 0.125" PTFE/Silicone Top Hat™ Septa	72 Pack
9A-130-2	40mL Amber, Black Polypropylene 24-400mm Open Top Closure, 0.125" PTFE/Silicone Top Hat™ Septa	72 Pack

60mL Vials - Class 2

Cat. No.	Description	Qty
9-135-2	60mL Clear, Black Polypropylene 24-400mm Open Top Closure, 0.125" PTFE/Silicone Top Hat™ Septa	72 Pack
9A-135-2	60mL Amber, Black Polypropylene 24-400mm Open Top Closure, 0.125" PTFE/Silicone Top Hat™ Septa	72 Pack

Precleaned and Certified

Assembled with Open Top Black Polypropylene Closures and Top Hat™ Septa

20mL Vials - Class 3

Cat. No.	Description	Qty
9-131-3	20mL Clear, Black Polypropylene 24-400mm Open Top Closure, 0.125" PTFE/Silicone Top Hat™ Septa	72 Pack
9A-131-3	20mL Amber, Black Polypropylene 24-400mm Open Top Closure, 0.125" PTFE/Silicone Top Hat™ Septa	72 Pack

40mL Vials - Class 3

Cat. No.	Description	Qty
9-130-3	40mL Clear, Black Polypropylene 24-400mm Open Top Closure, 0.125" PTFE/Silicone Top Hat™ Septa	72 Pack
9A-130-3	40mL Amber, Black Polypropylene 24-400mm Open Top Closure, 0.125" PTFE/Silicone Top Hat™ Septa	72 Pack

60mL Vials - Class 3

Cat. No.	Description	Qty
9-135-3	60mL Clear, Black Polypropylene 24-400mm Open Top Closure, 0.125" PTFE/Silicone Top Hat™ Septa	72 Pack
9A-135-3	60mL Amber, Black Polypropylene 24-400mm Open Top Closure, 0.125" PTFE/Silicone Top Hat™ Septa	72 Pack

*Don't see what you are looking for?
Please contact us. Any combination of products is available.*

VOA Vials - Solid Top Closures

Finneran Products Certified For Science™



- Available in clear or amber borosilicate glass
- Assembled with Solid Top PTFE-lined closures
- Available in standard, precleaned or precleaned/certified in accordance with recommended E.P.A. Protocol

CLASS 1: (Standard) Containers are assembled with liner and closure without washing treatment.

CLASS 2: (Precogned) Containers are processed according to EPA recommended wash procedures. Washed with laboratory grade biodegradable, non-phosphate detergent, rinsed with ASTM Type I De-ionized water, oven dried, and assembled in a contaminate-free environment. The exterior of each case is labeled with a lot number. Each case contains a copy of wash "Standard Operating Procedure."

CLASS 3: (Certified) Containers are processed according to EPA recommended wash procedures. Washed with laboratory grade biodegradable, non-phosphate detergent, rinsed with ASTM Type I De-ionized water, oven dried and assembled in a contaminate-free environment. The exterior of each case is labeled with a lot number. Each case contains a "Certificate of Analysis."

An independent laboratory is used to certify the container's cleanliness, assuring impartial results.

Standard

Assembled with Solid Top White Polypropylene Closures, PTFE Lined

20mL Vials - Class 1

Cat. No.	Description	Qty
9-121	20mL Clear, White Polypropylene 24-400mm Solid Top Closure, PTFE Lined	72 Pack
9A-121	20mL Amber, White Polypropylene 24-400mm Solid Top Closure, PTFE Lined	72 Pack
9-088	20mL Clear, White Polypropylene 24-400mm Solid Top Closure, PTFE Lined	100 Pack
9A-088	20mL Amber, White Polypropylene 24-400mm Solid Top Closure, PTFE Lined	100 Pack

40mL Vials - Class 1

Cat. No.	Description	Qty
9-120	40mL Clear, White Polypropylene 24-400mm Solid Top Closure, PTFE Lined	72 Pack
9A-120	40mL Amber, White Polypropylene 24-400mm Solid Top Closure, PTFE Lined	72 Pack
9-089	40mL Clear, White Polypropylene 24-400mm Solid Top Closure, PTFE Lined	100 Pack
9A-089	40mL Amber, White Polypropylene 24-400mm Solid Top Closure, PTFE Lined	100 Pack

60mL Vials - Class 1

Cat. No.	Description	Qty
9-129	60mL Clear, White Polypropylene 24-400mm Solid Top Closure, PTFE Lined	72 Pack
9A-129	60mL Amber, White Polypropylene 24-400mm Solid Top Closure, PTFE Lined	72 Pack
9-090	60mL Clear, White Polypropylene 24-400mm Solid Top Closure, PTFE Lined	100 Pack
9A-090	60mL Amber, White Polypropylene 24-400mm Solid Top Closure, PTFE Lined	100 Pack

Don't see what you are looking for?
Please contact us. Any combination of products is available.

VOA Vials - Solid Top Closures

Precleaned

Assembled with Solid Top White Polypropylene Closures, PTFE Lined

20mL Vials - Class 2

Cat. No.	Description	Qty
9-121-2	20mL Clear, White Polypropylene 24-400mm Solid Top Closure, PTFE Lined	72 Pack
9A-121-2	20mL Amber, White Polypropylene 24-400mm Solid Top Closure, PTFE Lined	72 Pack
9-088-2	20mL Clear, White Polypropylene 24-400mm Solid Top Closure, PTFE Lined	100 Pack
9A-088-2	20mL Amber, White Polypropylene 24-400mm Solid Top Closure, PTFE Lined	100 Pack

40mL Vials - Class 2

Cat. No.	Description	Qty
9-120-2	40mL Clear, White Polypropylene 24-400mm Solid Top Closure, PTFE Lined	72 Pack
9A-120-2	40mL Amber, White Polypropylene 24-400mm Solid Top Closure, PTFE Lined	72 Pack
9-089-2	40mL Clear, White Polypropylene 24-400mm Solid Top Closure, PTFE Lined	100 Pack
9A-089-2	40mL Amber, White Polypropylene 24-400mm Solid Top Closure, PTFE Lined	100 Pack

60mL Vials - Class 2

Cat. No.	Description	Qty
9-129-2	60mL Clear, White Polypropylene 24-400mm Solid Top Closure, PTFE Lined	72 Pack
9A-129-2	60mL Amber, White Polypropylene 24-400mm Solid Top Closure, PTFE Lined	72 Pack
9-090-2	60mL Clear, White Polypropylene 24-400mm Solid Top Closure, PTFE Lined	100 Pack
9A-090-2	60mL Amber, White Polypropylene 24-400mm Solid Top Closure, PTFE Lined	100 Pack

*Don't see what you are looking for?
Please contact us. Any combination of products is available.*

VOA Vials - Solid Top Closures

Pre-cleaned and Certified

Assembled with Solid Top White Polypropylene Closures, PTFE Lined

20mL Vials - Class 3

Cat. No.	Description	Qty
9-121-3	20mL Clear, White Polypropylene 24-400mm Solid Top Closure, PTFE Lined	72 Pack
9A-121-3	20mL Amber, White Polypropylene 24-400mm Solid Top Closure, PTFE Lined	72 Pack
9-088-3	20mL Clear, White Polypropylene 24-400mm Solid Top Closure, PTFE Lined	100 Pack
9A-088-3	20mL Amber, White Polypropylene 24-400mm Solid Top Closure, PTFE Lined	100 Pack

40mL Vials - Class 3

Cat. No.	Description	Qty
9-120-3	40mL Clear, White Polypropylene 24-400mm Solid Top Closure, PTFE Lined	72 Pack
9A-120-3	40mL Amber, White Polypropylene 24-400mm Solid Top Closure, PTFE Lined	72 Pack
9-089-3	40mL Clear, White Polypropylene 24-400mm Solid Top Closure, PTFE Lined	100 Pack
9A-089-3	40mL Amber, White Polypropylene 24-400mm Solid Top Closure, PTFE Lined	100 Pack

60mL Vials - Class 3

Cat. No.	Description	Qty
9-129-3	60mL Clear, White Polypropylene 24-400mm Solid Top Closure, PTFE Lined	72 Pack
9A-129-3	60mL Amber, White Polypropylene 24-400mm Solid Top Closure, PTFE Lined	72 Pack
9-090-3	60mL Clear, White Polypropylene 24-400mm Solid Top Closure, PTFE Lined	100 Pack
9A-090-3	60mL Amber, White Polypropylene 24-400mm Solid Top Closure, PTFE Lined	100 Pack

*Don't see what you are looking for?
Please contact us. Any combination of products is available.*

Environmental Vials, Closures and Septum

Finneran Products Certified For Science™



- Available in clear or amber borosilicate glass
- Choice of closure and liner, including patented Top Hat™ liner system
- Fixed (bonded) closures eliminate liner fallout

Vials - Class 1

Cat. No.	Description	Qty
D0376-20	20mL Clear Vial, 28x56mm, 24-400mm Thread	100 Pack
D0390-20	20mL Amber Vial, 28x56mm, 24-400mm Thread	100 Pack
320024-2856	20mL Clear Vial, 28x56mm, 24-400mm Thread	144 Pack
320024-2856A	20mL Amber Vial, 28x56mm, 24-400mm Thread	144 Pack
D0390-30	30mL Amber Vial, 28x72mm, 24-400mm Thread	100 Pack
330024-2872	30mL Clear Vial, 28x72mm, 24-400mm Thread	144 Pack
330024-2872A	30mL Amber Vial, 28x72mm, 24-400mm Thread	144 Pack
D0376-40	40mL Clear Vial, 28x95mm, 24-400mm Thread	100 Pack
D0390-40	40mL Amber Vial, 28x95mm, 24-400mm Thread	100 Pack
340024-2895	40mL Clear Vial, 28x95mm, 24-400mm Thread	144 Pack
340024-2895A	40mL Amber Vial, 28x95mm, 24-400mm Thread	144 Pack
D0376-60	60mL Clear Vial, 27x140mm, 24-400mm Thread	100 Pack
D0390-60	60mL Amber Vial, 27x140mm, 24-400mm Thread	100 Pack
36024-27140	60mL Clear Vial, 27x140mm, 24-400mm Thread	144 Pack
36024-27140A	60mL Amber Vial, 27x140mm, 24-400mm Thread	144 Pack

Closures - Class 1

Cat. No.	Description	Pack	Case
5310-24*	24-400mm Black, Polypropylene Open Hole Closure	100	1,000
5310-24414**	24-414mm Black, Polypropylene Open Hole Closure	100	1,000
5320-24	24-400mm Solid Top, Black Polypropylene Unlined Closure	100	1,000
5320-24W	24-400mm Solid Top, White Polypropylene Unlined Closure	100	1,000
5320-24414	24-414mm Solid Top, Black Polypropylene Unlined Closure	100	1,000
5320-24414W	24-414mm Solid Top, White Polypropylene Unlined Closure	100	1,000
5340-24	24-400mm Black, Polypropylene Glass-Filled Open Hole Closure	100	1,000
5360-24W	24-400mm Solid Top, White Polypropylene, PTFE/F217 Lined	100	1,000

* Available in additional colors; (G) Green, and (W) White

** Available in additional colors; (B) Blue, (G) Green, (GY) Gray, (O) Orange, (PK) Pink, (R) Red, (W) White, and (Y) Yellow

*Don't see what you are looking for?
Please contact us. Any combination of products is available.*

Environmental Vials, Closures and Septum

Closures with Liners - Class 1

Cat. No.	Description	Qty
38-375/100	24-414mm White, Polypropylene Open Hole Cap, Bonded .060" Thick PTFE/Silicone Liner	100 Pack
34-527	24-414mm, White Polypropylene Open Hole Closure, Fixed 0.125" PTFE/Silicone Liner	100 Pack
34-527/BLK	24-414mm, Black Polypropylene Open Hole Closure, Fixed 0.125" PTFE/Silicone Liner	100 Pack
34-527/144	24-414mm, White Polypropylene Open Hole Closure, Fixed 0.125" PTFE/Silicone Liner	144 Pack
34-527/M	24-414mm, White Polypropylene Open Hole Closure, Fixed 0.125" PTFE/Silicone Liner	1,000 Pack
34-375BLK	24-414mm, Black Polypropylene Open Hole Closure, Fixed 0.060" PTFE/Silicone Liner	100 Pack
D0396-24	24-400mm Black Phenolic Solid Top Closure, PE Cone	100 Pack
D0399-24	24-400mm, White Polypropylene Solid Top Closure, PTFE Lined	100 Pack
D0399-24/144	24-400mm, White Polypropylene Solid Top Closure, PTFE Lined	144 Pack
D0400-24	24-400mm, White Polypropylene Solid Top Closure, F217 Lined	100 Pack
D0400-24/144	24-400mm, White Polypropylene Solid Top Closure, F217 Lined	144 Pack
806550TH-24	24-400mm Black Polypropylene Open Top Closure, .0125" Top Hat™ PTFE/Silicone Lined (Patented)	100 Pack

Septum - Class 1

Cat. No.	Description	Qty
38-140	24mm x 0.015" PTFE	100 Pack
610050-24	24mm x 0.100" PTFE/Silicone Septa, 100 per pack	1,000 Case
612550-24	24mm x 0.125" PTFE/Silicone Septa, 100 per pack	1,000 Case

*Don't see what you are looking for?
Please contact us. Any combination of products is available.*

Amber Glass Wide Mouth Packers

Finneran Products Certified For Science™



-Amber glass bottles ideal for UV light-sensitive liquid samples

-Choice of closure and liner

-Available in standard, precleaned or precleaned/certified in accordance with recommended E.P.A. protocol

CLASS 1: (Standard) Containers are assembled with liner and closure without washing treatment.

CLASS 2: (Precleaned) Containers are processed according to EPA recommended wash procedures. Washed with laboratory grade biodegradable, non-phosphate detergent, rinsed with ASTM Type I De-ionized water, oven dried, and assembled in a contaminate-free environment. The exterior of each case is labeled with a lot number. Each case contains a copy of wash "Standard Operating Procedure."

CLASS 3: (Certified) Containers are processed according to EPA recommended wash procedures. Washed with laboratory grade biodegradable, non-phosphate detergent, rinsed with ASTM Type I De-ionized water, oven dried and assembled in a contaminate-free environment. The exterior of each case is labeled with a lot number. Each case contains a "Certificate of Analysis."

An independent laboratory is used to certify the container's cleanliness, assuring impartial results.

Standard

Assembled with White Polypropylene Closure, .015" PTFE Lined

Amber Glass Wide Mouth Packers - Class 1

Cat. No.	Description	Qty
9-219	1/2 oz, 15cc Packer, 28-400mm Thread, White Polypropylene Closure, PTFE Lined	24 Pack
9-220	1 oz, 30cc Packer, 28-400mm Thread, White Polypropylene Closure, PTFE Lined	24 Pack
9-221	2 oz, 60cc Packer, 33-400mm Thread, White Polypropylene Closure, PTFE Lined	24 Pack
9-222	4 oz, 120cc Packer, 38-400mm Thread, White Polypropylene Closure, PTFE Lined	24 Pack
9-223	8 oz, 250cc Packer, 45-400mm Thread, White Polypropylene Closure, PTFE Lined	24 Pack
9-224	16 oz, 500cc Packer, 53-400mm Thread, White Polypropylene Closure, PTFE Lined	12 Pack
9-225	32 oz, 950cc Packer, 53-400mm Thread, White Polypropylene Closure, PTFE Lined	12 Pack
9-226	80 oz, 2500cc Packer, 70-400mm Thread, White Polypropylene Closure, PTFE Lined	4 Pack

Don't see what you are looking for?
Please contact us. Any combination of products is available.

Amber Glass Wide Mouth Packers

Precleaned

Assembled with White Polypropylene Closure, .015" PTFE Lined

Amber Glass Wide Mouth Packers - Class 2

Cat. No.	Description	Qty
9-219-2	1/2 oz, 15cc Packer, 28-400mm Thread, White Polypropylene Closure, PTFE Lined	24 Pack
9-220-2	1 oz, 30cc Packer, 28-400mm Thread, White Polypropylene Closure, PTFE Lined	24 Pack
9-221-2	2oz, 60cc Packer, 33-400mm Thread, White Polypropylene Closure, PTFE Lined	24 Pack
9-222-2	4 oz, 120cc Packer, 38-400mm Thread, White Polypropylene Closure, PTFE Lined	24 Pack
9-223-2	8 oz, 250cc Packer, 45-400mm Thread, White Polypropylene Closure, PTFE Lined	24 Pack
9-224-2	16 oz, 500cc Packer, 53-400mm Thread, White Polypropylene Closure, PTFE Lined	12 Pack
9-225-2	32 oz, 950cc Packer, 53-400mm Thread, White Polypropylene Closure, PTFE Lined	12 Pack
9-226-2	80 oz, 2500cc Packer, 70-400mm Thread, White Polypropylene Closure, PTFE Lined	4 Pack

Precleaned & Certified

Assembled with White Polypropylene Closure, .015" PTFE Lined

Amber Glass Wide Mouth Packers - Class 3

Cat. No.	Description	Qty
9-220-3	1 oz, 30cc Packer, 28-400mm Thread, White Polypropylene Closure, PTFE Lined	24 Pack
9-221-3	2 oz, 60cc Packer, 33-400mm Thread, White Polypropylene Closure, PTFE Lined	24 Pack
9-222-3	4 oz, 120cc Packer, 38-400mm Thread, White Polypropylene Closure, PTFE Lined	24 Pack
9-223-3	8 oz, 250cc Packer, 45-400mm Thread, White Polypropylene Closure, PTFE Lined	24 Pack
9-224-3	16 oz, 500cc Packer, 53-400mm Thread, White Polypropylene Closure, PTFE Lined	12 Pack
9-225-3	32 oz, 950cc Packer, 53-400mm Thread, White Polypropylene Closure, PTFE Lined	12 Pack

*Don't see what you are looking for?
Please contact us. Any combination of products is available.*

Amber Glass Wide Mouth Packers with Assorted Closures

Standard

Assembled with Black Phenolic Closure/PE Cone Lined

Amber Glass Wide Mouth Packers - Class 1

Cat. No.	Description	Qty
D0173-1/2	1/2 oz, 15cc Packer, 28-400mm Thread, Black Phenolic Closure, PE Cone Lined	24 Pack
D0173-1	1 oz, 30cc Packer, 28-400mm Thread, Black Phenolic Closure, PE Cone Lined	24 Pack
D0173-2	2 oz, 60cc Packer, 33-400mm Thread, Black Phenolic Closure, PE Cone Lined	24 Pack
D0173-4	4 oz, 120cc Packer, 38-400mm Thread, Black Phenolic Closure, PE Cone Lined	24 Pack

Assembled with White Polypropylene Closure, F217 Lined

Amber Glass Wide Mouth Packers - Class 1

Cat. No.	Description	Qty
D0180-1/2	1/2 oz, 15cc Packer, 28-400mm Thread, White Polypropylene Closure, F217 Lined	24 Pack
D0180-1	1 oz, 30cc Packer, 28-400mm Thread, White Polypropylene Closure, F217 Lined	24 Pack
D0180-2	2 oz, 60cc Packer, 33-400mm Thread, White Polypropylene Closure, F217 Lined	24 Pack
D0180-4	4 oz, 120cc Packer, 38-400mm Thread, White Polypropylene Closure, F217 Lined	24 Pack
D0180-8	8 oz, 250cc Packer, 45-400mm Thread, White Polypropylene Closure, F217 Lined	24 Pack
D0180-16	16 oz, 500cc Packer, 53-400mm Thread, White Polypropylene Closure, F217 Lined	12 Pack
D0180-32	32 oz, 950cc Packer, 53-400mm Thread, White Polypropylene Closure, F217 Lined	12 Pack
D0180-80	80 oz, 2500cc Packer, 70-400mm Thread, White Polypropylene Closure, F217 Lined	4 Pack

Assembled White Polypropylene Closure, Unlined

Amber Glass Wide Mouth Packers - Class 1

Cat. No.	Description	Qty
D0178-1/2	1/2 oz, 15cc Packer, 28-400mm Thread, White Polypropylene Closure, Unlined	24 Pack
D0178-1	1 oz, 30cc Packer, 28-400mm Thread, White Polypropylene Closure, Unlined	24 Pack
D0178-2	2 oz, 60cc Packer, 33-400mm Thread, White Polypropylene Closure, Unlined	24 Pack
D0178-4	4 oz, 120cc Packer, 38-400mm Thread, White Polypropylene Closure, Unlined	24 Pack
D0178-8	8 oz, 250cc Packer, 45-400mm Thread, White Polypropylene Closure, Unlined	24 Pack
D0178-16	16 oz, 500cc Packer, 53-400mm Thread, White Polypropylene Closure, Unlined	12 Pack
D0178-32	32 oz, 950cc Packer, 53-400mm Thread, White Polypropylene Closure, Unlined	12 Pack
D0178-80	80 oz, 2500cc Packer, 70-400mm Thread, White Polypropylene Closure, Unlined	4 Pack

*Don't see what you are looking for?
Please contact us. Any combination of products is available.*

Amber Glass Wide Mouth Packers with Assorted Closures

Standard

Without Closures

Amber Glass Wide Mouth Packers - Class 1		
Cat. No.	Description	Qty
D0179-1/2	1/2 oz, 15cc Packer, 28-400mm Thread	24 Pack
D0179B-1/2	1/2 oz, 15cc Packer, 28-400mm Thread - Bulk Pack	624 Pieces
D0179-1	1 oz, 30cc Packer, 28-400mm Thread	24 Pack
D0179B-1	1 oz, 30cc Packer, 28-400mm Thread - Bulk Pack	432 Pieces
D0179-2	2 oz, 60cc Packer, 33-400mm Thread	24 Pack
D0179-4	4 oz, 120cc Packer, 38-400mm Thread	24 Pack
D0179-8	8 oz, 250cc Packer, 45-400mm Thread	24 Pack
D0179-16	16 oz, 500cc Packer, 53-400mm Thread	12 Pack
D0179-32	32 oz, 950cc Packer, 53-400mm Thread	12 Pack
D0179-80	80 oz, 2500cc Packer, 70-400mm Thread	4 Pack

*Don't see what you are looking for?
Please contact us. Any combination of products is available.*

Boston Round Glass Bottles

Finneran Products Certified For Science™



- Available in clear or amber borosilicate glass
- Choice of closure and liner
- Available in standard, precleaned or precleaned/certified in accordance with recommended E.P.A. Protocol

CLASS 1: (Standard) Containers are assembled with liner and closure without washing treatment.

CLASS 2: (Precleaned) Containers are processed according to EPA recommended wash procedures. Washed with laboratory grade biodegradable, non-phosphate detergent, rinsed with ASTM Type I De-ionized water, oven dried, and assembled in a contaminate-free environment. The exterior of each case is labeled with a lot number. Each case contains a copy of wash "Standard Operating Procedure."

CLASS 3: (Certified) Containers are processed according to EPA recommended wash procedures. Washed with laboratory grade biodegradable, non-phosphate detergent, rinsed with ASTM Type I De-ionized water, oven dried and assembled in a contaminate-free environment. The exterior of each case is labeled with a lot number. Each case contains a "Certificate of Analysis."

An independent laboratory is used to certify the container's cleanliness, assuring impartial results.

Standard

Assembled with White Polypropylene Closure, .015" PTFE Lined

Clear Glass Boston Round Bottles - Class 1

Cat. No.	Description	Qty
9-170	1 oz, 30mL Clear Boston Round Bottle, 20-400mm Thread, White Closure, PTFE Lined	24 Pack
9-171	2 oz, 60mL Clear Boston Round Bottle, 20-400mm Thread, White Closure, PTFE Lined	24 Pack
9-172	4 oz, 125mL Clear Boston Round Bottle, 22-400mm Thread, White Closure, PTFE Lined	24 Pack
9-173	8 oz, 250mL Clear Boston Round Bottle, 24-400mm Thread, White Closure, PTFE Lined	12 Pack
9-174	16 oz, 500mL Clear Boston Round Bottle, 28-400mm Thread, White Closure, PTFE Lined	12 Pack
9-175	32 oz, 1000mL Clear Boston Round Bottle, 33-400mm Thread, White Closure, PTFE Lined	12 Pack

Amber Glass Boston Round Bottles - Class 1

Cat. No.	Description	Qty
9A-170	1 oz, 30mL Amber Boston Round Bottle, 20-400mm Thread, White Closure, PTFE Lined	24 Pack
9A-171	2 oz, 60mL Amber Boston Round Bottle, 20-400mm Thread, White Closure, PTFE Lined	24 Pack
9A-172	4 oz, 125mL Amber Boston Round Bottle, 22-400mm Thread, White Closure, PTFE Lined	24 Pack
9A-173	8 oz, 250mL Amber Boston Round Bottle, 24-400mm Thread, White Closure, PTFE Lined	12 Pack
9A-174	16 oz, 500mL Amber Boston Round Bottle, 28-400mm Thread, White Closure, PTFE Lined	12 Pack
9A-175	32 oz, 1000mL Amber Boston Round Bottle, 33-400mm Thread, White Closure, PTFE Lined	12 Pack

Don't see what you are looking for?
Please contact us. Any combination of products is available.

Boston Round Glass Bottles

Precleaned

Assembled with White Polypropylene Closure, .015" PTFE Lined

Clear Glass Boston Round Bottles - Class 2

Cat. No.	Description	Qty
9-170-2	1 oz, 30mL Clear Boston Round Bottle, 20-400mm Thread, White Closure, PTFE Lined	24 Pack
9-171-2	2 oz, 60mL Clear Boston Round Bottle, 20-400mm Thread, White Closure, PTFE Lined	24 Pack
9-172-2	4 oz, 125mL Clear Boston Round Bottle, 22-400mm Thread, White Closure, PTFE Lined	24 Pack
9-173-2	8 oz, 250mL Clear Boston Round Bottle, 24-400mm Thread, White Closure, PTFE Lined	12 Pack
9-174-2	16 oz, 500mL Clear Boston Round Bottle, 28-400mm Thread, White Closure, PTFE Lined	12 Pack
9-175-2	32 oz, 1000mL Clear Boston Round Bottle, 33-400mm Thread, White Closure, PTFE Lined	12 Pack

Assembled with White Polypropylene Closure, .015" PTFE Lined

Amber Glass Boston Round Bottles - Class 2

Cat. No.	Description	Qty
9A-170-2	1 oz, 30mL Amber Boston Round Bottle, 20-400mm Thread, White Closure, PTFE Lined	24 Pack
9A-171-2	2 oz, 60mL Amber Boston Round Bottle, 20-400mm Thread, White Closure, PTFE Lined	24 Pack
9A-172-2	4 oz, 125mL Amber Boston Round Bottle, 22-400mm Thread, White Closure, PTFE Lined	24 Pack
9A-173-2	8 oz, 250mL Amber Boston Round Bottle, 24-400mm Thread, White Closure, PTFE Lined	12 Pack
9A-174-2	16 oz, 500mL Amber Boston Round Bottle, 28-400mm Thread, White Closure, PTFE Lined	12 Pack
9A-175-2	32 oz, 1000mL Amber Boston Round Bottle, 33-400mm Thread, White Closure, PTFE Lined	12 Pack

Precleaned and Certified

Assembled with White Polypropylene Closure, .015" PTFE Lined

Clear Glass Boston Round Bottles - Class 3

Cat. No.	Description	Qty
9-170-3	1 oz, 30mL Clear Boston Round Bottle, 20-400mm Thread, White Closure, PTFE Lined	24 Pack
9-171-3	2 oz, 60mL Clear Boston Round Bottle, 20-400mm Thread, White Closure, PTFE Lined	24 Pack
9-172-3	4 oz, 125mL Clear Boston Round Bottle, 22-400mm Thread, White Closure, PTFE Lined	24 Pack
9-173-3	8 oz, 250mL Clear Boston Round Bottle, 24-400mm Thread, White Closure, PTFE Lined	12 Pack
9-174-3	16 oz, 500mL Clear Boston Round Bottle, 28-400mm Thread, White Closure, PTFE Lined	12 Pack
9-175-3	32 oz, 1000mL Clear Boston Round Bottle, 33-400mm Thread, White Closure, PTFE Lined	12 Pack

*Don't see what you are looking for?
Please contact us. Any combination of products is available.*

Boston Round Glass Bottles

Precleaned and Certified

Assembled with White Polypropylene Closure, .015" PTFE Lined

Amber Glass Boston Round Bottles - Class 3

Cat. No.	Description	Qty
9A-170-3	1 oz, 30mL Amber Boston Round Bottle, 20-400mm Thread, White Closure, PTFE Lined	24 Pack
9A-171-3	2 oz, 60mL Amber Boston Round Bottle, 20-400mm Thread, White Closure, PTFE Lined	24 Pack
9A-172-3	4 oz, 125mL Amber Boston Round Bottle, 22-400mm Thread, White Closure, PTFE Lined	24 Pack
9A-173-3	8 oz, 250mL Amber Boston Round Bottle, 24-400mm Thread, White Closure, PTFE Lined	12 Pack
9A-174-3	16 oz, 500mL Amber Boston Round Bottle, 28-400mm Thread, White Closure, PTFE Lined	12 Pack
9A-175-3	32 oz, 1000mL Amber Boston Round Bottle, 33-400mm Thread, White Closure, PTFE Lined	12 Pack

*Don't see what you are looking for?
Please contact us. Any combination of products is available.*

Boston Round Glass Bottles with Assorted Closures

Standard

Assembled with Black Phenolic Closure/PE Cone Lined

Clear Glass Boston Round Bottles - Class 1

Cat. No.	Description	Qty
D0149-1/2	1/2 oz, 15mL Clear Boston Round Bottle, 18-400mm Thread, Black Phenolic Closure, PE Cone Lined	24 Pack
D0149-1	1 oz, 30mL Clear Boston Round Bottle, 20-400mm Thread, Black Phenolic Closure, PE Cone Lined	24 Pack
D0149-2	2 oz, 60mL Clear Boston Round Bottle, 20-400mm Thread, Black Phenolic Closure, PE Cone Lined	24 Pack
D0149-4	4 oz, 125mL Clear Boston Round Bottle, 22-400mm Thread, Black Phenolic Closure, PE Cone Lined	24 Pack
D0149-8	8 oz, 250mL Clear Boston Round Bottle, 24-400mm Thread, Black Phenolic Closure, PE Cone Lined	12 Pack
D0149-16	16 oz, 500mL Clear Boston Round Bottle, 28-400mm Thread, Black Phenolic Closure, PE Cone Lined	12 Pack
D0149-32	32 oz, 1000mL Clear Boston Round Bottle, 33-400mm Thread, Black Phenolic Closure, PE Cone Lined	12 Pack

Amber Glass Boston Round Bottles - Class 1

Cat. No.	Description	Qty
D0161-1/2	1/2 oz, 15mL Amber Boston Round Bottle, 18-400mm Thread, Black Phenolic Closure, PE Cone Lined	24 Pack
D0161-1	1 oz, 30mL Amber Boston Round Bottle, 20-400mm Thread, Black Phenolic Closure, PE Cone Lined	24 Pack
D0161-2	2 oz, 60mL Amber Boston Round Bottle, 20-400mm Thread, Black Phenolic Closure, PE Cone Lined	24 Pack
D0161-4	4 oz, 125mL Amber Boston Round Bottle, 22-400mm Thread, Black Phenolic Closure, PE Cone Lined	24 Pack
D0161-8	8 oz, 250mL Amber Boston Round Bottle, 24-400mm Thread, Black Phenolic Closure, PE Cone Lined	12 Pack
D0161-16	16 oz, 500mL Amber Boston Round Bottle, 28-400mm Thread, Black Phenolic Closure, PE Cone Lined	12 Pack
D0161-32	32 oz, 1000mL Amber Boston Round Bottle, 33-400mm Thread, Black Phenolic Closure, PE Cone Lined	12 Pack

Assembled with White Polypropylene Closure, F217 Lined

Clear Glass Boston Round Bottles - Class 1

Cat. No.	Description	Qty
D0156-1	1 oz, 30mL Clear Boston Round Bottle, 20-400mm Thread, White Polypropylene Closure, F217 Lined	24 Pack
D0156-2	2 oz, 60mL Clear Boston Round Bottle, 20-400mm Thread, White Polypropylene Closure, F217 Lined	24 Pack
D0156-4	4 oz, 125mL Clear Boston Round Bottle, 22-400mm Thread, White Polypropylene Closure, F217 Lined	24 Pack
D0156-8	8 oz, 250mL Clear Boston Round Bottle, 24-400mm Thread, White Polypropylene Closure, F217 Lined	12 Pack
D0156-16	16 oz, 500mL Clear Boston Round Bottle, 28-400mm Thread, White Polypropylene Closure, F217 Lined	12 Pack
D0156-32	32 oz, 1000mL Clear Boston Round Bottle, 33-400mm Thread, White Polypropylene Closure, F217 Lined	12 Pack

*Don't see what you are looking for?
Please contact us. Any combination of products is available.*

Boston Round Glass Bottles with Assorted Closures

Standard

Assembled with White Polypropylene Closure, F217 Lined

Amber Glass Boston Round Bottles - Class 1

Cat. No.	Description	Qty
D0168-1	1 oz, 30mL Amber Boston Round Bottle, 20-400mm Thread, White Polypropylene Closure, F217 Lined	24 Pack
D0168-2	2 oz, 60mL Amber Boston Round Bottle, 20-400mm Thread, White Polypropylene Closure, F217 Lined	24 Pack
D0168-4	4 oz, 125mL Amber Boston Round Bottle, 22-400mm Thread, White Polypropylene Closure, F217 Lined	24 Pack
D0168-8	8 oz, 250mL Amber Boston Round Bottle, 24-400mm Thread, White Polypropylene Closure, F217 Lined	12 Pack
D0168-16	16 oz, 500mL Amber Boston Round Bottle, 28-400mm Thread, White Polypropylene Closure, F217 Lined	12 Pack
D0168-32	32 oz, 1000mL Amber Boston Round Bottle, 33-400mm Thread, White Polypropylene Closure, F217 Lined	12 Pack

Assembled with White Polypropylene Closure, Unlined

Clear Glass Boston Round Bottles - Class 1

Cat. No.	Description	Qty
D0154-1	1 oz, 30mL Clear Boston Round Bottle, 20-400mm Thread, White Polypropylene Closure, Unlined	24 Pack
D0154-2	2 oz, 60mL Clear Boston Round Bottle, 20-400mm Thread, White Polypropylene Closure, Unlined	24 Pack
D0154-4	4 oz, 125mL Clear Boston Round Bottle, 22-400mm Thread, White Polypropylene Closure, Unlined	24 Pack
D0154-8	8 oz, 250mL Clear Boston Round Bottle, 24-400mm Thread, White Polypropylene Closure, Unlined	12 Pack
D0154-16	16 oz, 500mL Clear Boston Round Bottle, 28-400mm Thread, White Polypropylene Closure, Unlined	12 Pack
D0154-32	32 oz, 1000mL Clear Boston Round Bottle, 33-400mm Thread, White Polypropylene Closure, Unlined	12 Pack

Amber Glass Boston Round Bottles - Class 1

Cat. No.	Description	Qty
D0166-1	1 oz, 30mL Amber Boston Round Bottle, 20-400mm Thread, White Polypropylene Closure, Unlined	24 Pack
D0166-2	2 oz, 60mL Amber Boston Round Bottle, 20-400mm Thread, White Polypropylene Closure, Unlined	24 Pack
D0166-4	4 oz, 125mL Amber Boston Round Bottle, 22-400mm Thread, White Polypropylene Closure, Unlined	24 Pack
D0166-8	8 oz, 250mL Amber Boston Round Bottle, 24-400mm Thread, White Polypropylene Closure, Unlined	12 Pack
D0166-16	16 oz, 500mL Amber Boston Round Bottle, 28-400mm Thread, White Polypropylene Closure, Unlined	12 Pack
D0166-32	32 oz, 1000mL Amber Boston Round Bottle, 33-400mm Thread, White Polypropylene Closure, Unlined	12 Pack

*Don't see what you are looking for?
Please contact us. Any combination of products is available.*

Boston Round Glass Bottles with Assorted Closures

Standard

Without Closures

Clear Glass Boston Round Bottles - Class 1

Cat. No.	Description	Qty
D0155-1/2	1/2 oz, 15mL Clear Boston Round Bottle, 18-400mm Thread	24 Pack
D0155B-1/2	1/2 oz, 15mL Clear Boston Round Bottle, 18-400mm Thread - Bulk Pack	720 Pieces
D0155-1	1 oz, 30mL Clear Boston Round Bottle, 20-400mm Thread	24 Pack
D0155B-1	1 oz, 30mL Clear Boston Round Bottle, 20-400mm Thread - Bulk Pack	432 Pieces
D0155-2	2 oz, 60mL Clear Boston Round Bottle, Cap, 20-400mm Thread	24 Pack
D0155B-2	2 oz, 60mL Clear Boston Round Bottle, Cap, 20-400mm Thread - Bulk Pack	288 Pieces
D0155-4	4 oz, 125mL Clear Boston Round Bottle, Cap, 22-400mm Thread	24 Pack
D0155B-4	4 oz, 125mL Clear Boston Round Bottle, Cap, 22-400mm Thread - Bulk Pack	160 Pieces
D0155-8	8 oz, 250mL Clear Boston Round Bottle, Cap, 24-400mm Thread	12 Pack
D0155-16	16 oz, 500mL Clear Boston Round Bottle, Cap, 28-400mm Thread	12 Pack
D0155-32	32 oz, 1000mL Clear Boston Round Bottle, Cap, 33-400mm Thread	12 Pack

Amber Glass Boston Round Bottles - Class 1

Cat. No.	Description	Qty
D0167-1/2	1/2 oz, 15mL Amber Boston Round Bottle, 18-400mm Thread	24 Pack
D0167B-1/2	1/2 oz, 15mL Amber Boston Round Bottle, 18-400mm Thread - Bulk Pack	720 Pieces
D0167-1	1 oz, 30mL Amber Boston Round Bottle, 20-400mm Thread	24 Pack
D0167B-1	1 oz, 30mL Amber Boston Round Bottle, 20-400mm Thread - Bulk Pack	432 Pieces
D0167-2	2 oz, 60mL Amber Boston Round Bottle, Cap, 20-400mm Thread	24 Pack
D0167B-2	2 oz, 60mL Amber Boston Round Bottle, Cap, 20-400mm Thread - Bulk Pack	288 Pieces
D0167-4	4 oz, 125mL Amber Boston Round Bottle, Cap, 22-400mm Thread	24 Pack
D0167B-4	4 oz, 125mL Amber Boston Round Bottle, Cap, 22-400mm Thread - Bulk Pack	160 Pieces
D0167-8	8 oz, 250mL Amber Boston Round Bottle, Cap, 24-400mm Thread	12 Pack
D0167-16	16 oz, 500mL Amber Boston Round Bottle, Cap, 28-400mm Thread	12 Pack
D0167-32	32 oz, 1000mL Amber Boston Round Bottle, Cap, 33-400mm Thread	12 Pack

*Don't see what you are looking for?
Please contact us. Any combination of products is available.*

Clear Glass Straight Sided Wide Mouth Jars - Short and Tall

Finneran Products Certified For Science™



- Ideal for use in soil, sediment and sludge sampling
- Preassembled with .015" PTFE or F217 lined closed top white polypropylene closures
- Available in standard, precleaned or precleaned/certified in accordance with recommended E.P.A. Protocol

CLASS 1: (Standard) Containers are assembled with liner and closure without washing treatment.

CLASS 2: (Precleaned) Containers are processed according to EPA recommended wash procedures. Washed with laboratory grade biodegradable, non-phosphate detergent, rinsed with ASTM Type I De-ionized water, oven dried, and assembled in a contaminate-free environment. The exterior of each case is labeled with a lot number. Each case contains a copy of wash "Standard Operating Procedure."

CLASS 3: (Certified) Containers are processed according to EPA recommended wash procedures. Washed with laboratory grade biodegradable, non-phosphate detergent, rinsed with ASTM Type I De-ionized water, oven dried and assembled in a contaminate-free environment. The exterior of each case is labeled with a lot number. Each case contains a "Certificate of Analysis."

An independent laboratory is used to certify the container's cleanliness, assuring impartial results.

Standard

Assembled with White Polypropylene Closure, .015" PTFE Lined

Clear Glass Short Straight Sided Wide Mouth Jars - Class 1

Cat. No.	Description	Qty
9-180	2 oz, 60mL Clear Jar, 53-400mm Thread, White Polypropylene Closure, PTFE Lined	24 Pack
9-181	4 oz, 125mL Clear Jar, 58-400mm Thread, White Polypropylene Closure, PTFE Lined	24 Pack
9-182	8 oz, 250mL Clear Jar, 70-400mm Thread, White Polypropylene Closure, PTFE Lined	24 Pack
9-183	16 oz, 500mL Clear Jar, 89-400mm Thread, White Polypropylene Closure, PTFE Lined	12 Pack
9-184	32 oz, 1000mL Clear Jar, 89-400mm Thread, White Polypropylene Closure, PTFE Lined	12 Pack

Clear Glass Tall Straight Sided Wide Mouth Jars - Class 1

Cat. No.	Description	Qty
9-190	4 oz, 125mL Clear Tall Jar, 48-400mm Thread, White Polypropylene Closure, PTFE Lined	24 Pack
9-191	8 oz, 250mL Clear Tall Jar, 58-400mm Thread, White Polypropylene Closure, PTFE Lined	12 Pack
9-192	16 oz, 500mL Clear Tall Jar, 70-400mm Thread, White Polypropylene Closure, PTFE Lined	12 Pack
9-193	64 oz, 2000mL Clear Tall Jar, 83-400mm Thread, White Polypropylene Closure, PTFE Lined	6 Pack
9-194	128 oz, 4000mL Clear Tall Jar, 89-400mm Thread, White Polypropylene Closure, PTFE Lined	4 Pack

Don't see what you are looking for?
Please contact us. Any combination of products is available.

Clear Glass Straight Sided Wide Mouth Jars - Short and Tall

Precleaned

Assembled with White Polypropylene Closure, .015" PTFE Lined

Clear Glass Short Straight Sided Wide Mouth Jars - Class 2

Cat. No.	Description	Qty
9-180-2	2 oz, 60mL Clear Jar, 53-400mm Thread, White Polypropylene Closure, PTFE Lined	24 Pack
9-181-2	4 oz, 125mL Clear Jar, 58-400mm Thread, White Polypropylene Closure, PTFE Lined	24 Pack
9-182-2	8 oz, 250mL Clear Jar, 70-400mm Thread, White Polypropylene Closure, PTFE Lined	24 Pack
9-183-2	16 oz, 500mL Clear Jar, 89-400mm Thread, White Polypropylene Closure, PTFE Lined	12 Pack
9-184-2	32 oz, 1000mL Clear Jar, 89-400mm Thread, White Polypropylene Closure, PTFE Lined	12 Pack

Clear Glass Tall Straight Sided Wide Mouth Jars - Class 2

Cat. No.	Description	Qty
9-190-2	4 oz, 125mL Clear Tall Jar, 48-400mm Thread, White Polypropylene Closure, PTFE Lined	24 Pack
9-191-2	8 oz, 250mL Clear Tall Jar, 58-400mm Thread, White Polypropylene Closure, PTFE Lined	12 Pack
9-192-2	16 oz, 500mL Clear Tall Jar, 70-400mm Thread, White Polypropylene Closure, PTFE Lined	12 Pack
9-193-2	64 oz, 2000mL Clear Tall Jar, 83-400mm Thread, White Polypropylene Closure, PTFE Lined	6 Pack
9-194-2	128 oz, 4000mL Clear Tall Jar, 89-400mm Thread, White Polypropylene Closure, PTFE Lined	4 Pack

Precleaned and Certified

Assembled with White Polypropylene Closure, .015" PTFE Lined

Clear Glass Short Straight Sided Wide Mouth Jars - Class 3

Cat. No.	Description	Qty
9-180-3	2 oz, 60mL Clear Jar, 53-400mm Thread, White Polypropylene Closure, PTFE Lined	24 Pack
9-181-3	4 oz, 125mL Clear Jar, 58-400mm Thread, White Polypropylene Closure, PTFE Lined	24 Pack
9-182-3	8 oz, 250mL Clear Jar, 70-400mm Thread, White Polypropylene Closure, PTFE Lined	24 Pack
9-183-3	16 oz, 500mL Clear Jar, 89-400mm Thread, White Polypropylene Closure, PTFE Lined	12 Pack
9-184-3	32 oz, 1000mL Clear Jar, 89-400mm Thread, White Polypropylene Closure, PTFE Lined	12 Pack

Clear Glass Tall Straight Sided Wide Mouth Jars - Class 3

Cat. No.	Description	Qty
9-190-3	4 oz, 125mL Clear Tall Jar, 48-400mm Thread, White Polypropylene Closure, PTFE Lined	24 Pack
9-191-3	8 oz, 250mL Clear Tall Jar, 58-400mm Thread, White Polypropylene Closure, PTFE Lined	12 Pack
9-192-3	16 oz, 500mL Clear Tall Jar, 70-400mm Thread, White Polypropylene Closure, PTFE Lined	12 Pack
9-193-3	64 oz, 2000mL Clear Tall Jar, 83-400mm Thread, White Polypropylene Closure, PTFE Lined	6 Pack

*Don't see what you are looking for?
Please contact us. Any combination of products is available.*

Clear Glass Straight Sided Wide Mouth Jars - Short and Tall with Assorted Closures

Standard

Assembled with White Polypropylene Closure, F217 Lined

Clear Glass Short Straight Sided Wide Mouth Jars - Class 1

Cat. No.	Description	Qty
D0086-2	2 oz, 60mL Clear Jar, 53-400mm Thread, White Polypropylene Closure, F217 Lined	24 Pack
D0086-4	4 oz, 125mL Clear Jar, 58-400mm Thread, White Polypropylene Closure, F217 Lined	24 Pack
D0086-8	8 oz, 250mL Clear Jar, 70-400mm Thread, White Polypropylene Closure, F217 Lined	24 Pack
D0086-16	16 oz, 500mL Clear Jar, 89-400mm Thread, White Polypropylene Closure, F217 Lined	12 Pack
D0086-32	32 oz, 1000mL Clear Jar, 89-400mm Thread, White Polypropylene Closure, F217 Lined	12 Pack

Clear Glass Tall Straight Sided Wide Mouth Jars - Class 1

Cat. No.	Description	Qty
D0098-1	1 oz, 30mL Clear Tall Jar, 33-400mm Thread, White Polypropylene Closure, F217 Lined	24 Pack
D0098-2	2 oz, 60mL Clear Tall Jar, 38-400mm Thread, White Polypropylene Closure, F217 Lined	24 Pack
D0098-4	4 oz, 250ml Clear Tall Jar, 48-400mm Thread, White Polypropylene Closure, F217 Lined	24 Pack
D0098-8	8 oz, 250mL Clear Tall Jar, 58-400mm Thread, White Polypropylene Closure, F217 Lined	12 Pack
D0098-16	16 oz, 500mL Clear Tall Jar, 70-400mm Thread, White Polypropylene Closure, F217 Lined	12 Pack

Assembled with White Polypropylene Closure, Unlined

Clear Glass Short Straight Sided Wide Mouth Jars - Class 1

Cat. No.	Description	Qty
D0084-2	2 oz, 60mL Clear Jar, 53-400mm Thread, White Polypropylene Closure, Unlined	24 Pack
D0084-4	4 oz, 125mL Clear Jar, 58-400mm Thread, White Polypropylene Closure, Unlined	24 Pack
D0084-8	8 oz, 250mL Clear Jar, 70-400mm Thread, White Polypropylene Closure, Unlined	24 Pack
D0084-16	16 oz, 500mL Clear Jar, 89-400mm Thread, White Polypropylene Closure, Unlined	12 Pack
D0084-32	32 oz, 1000mL Clear Jar, 89-400mm Thread, White Polypropylene Closure, Unlined	12 Pack

Clear Glass Tall Straight Sided Wide Mouth Jars - Class 1

Cat. No.	Description	Qty
D0096-1	1 oz, 30mL Clear Tall Jar, 33-400mm Thread, White Polypropylene Closure, Unlined	24 Pack
D0096-2	2 oz, 60mL Clear Tall Jar, 38-400mm Thread, White Polypropylene Closure, Unlined	24 Pack
D0096-4	4 oz, 125mL Clear Tall Jar, 48-400mm Thread, White Polypropylene Closure, Unlined	24 Pack
D0096-8	8 oz, 250mL Clear Tall Jar, 58-400mm Thread, White Polypropylene Closure, Unlined	12 Pack
D0096-16	16 oz, 500mL Clear Tall Jar, 70-400mm Thread, White Polypropylene Closure, Unlined	12 Pack

*Don't see what you are looking for?
Please contact us. Any combination of products is available.*

Clear Glass Straight Sided Wide Mouth Jars - Short and Tall with Assorted Closures

Standard

Without Closures

Clear Glass Short Straight Sided Wide Mouth Jars - Class 1

Cat. No.	Description	Qty
D0085-2	2 oz, 60mL Clear Jar, 53-400mm Thread	24 Pack
D0085-4	4 oz, 125mL Clear Jar, 58-400mm Thread	24 Pack
D0085-8	8 oz, 250mL Clear Jar, 70-400mm Thread	24 Pack
D0085-16	16 oz, 500mL Clear Jar, 89-400mm Thread	12 Pack
D0085-32	32 oz, 1000mL Clear Jar, 89-400mm Thread	12 Pack

Clear Glass Tall Straight Sided Wide Mouth Jars - Class 1

Cat. No.	Description	Qty
D0097-1	1 oz, 30mL Clear Tall Jar, 33-400mm Thread	24 Pack
D0097-2	2 oz, 60mL Clear Tall Jar, 38-400mm Thread	24 Pack
D0097-4	4 oz, 125mL Clear Tall Jar, 48-400mm Thread	24 Pack
D0097-8	8 oz, 250mL Clear Tall Jar, 58-400mm Thread	12 Pack
D0097-16	16 oz, 500mL Clear Tall Jar, 70-400mm Thread	12 Pack

*Don't see what you are looking for?
Please contact us. Any combination of products is available.*

High Density Polyethylene Wide Mouth Jars

Finneran Products Certified For Science™



HDPE Wide Mouth Jars

- *Preassembled with foamed polyethylene lined polypropylene closures*
- *All HDPE bottles and jars are also available with PTFE-lined closures or unlined closures.*
- *Available in standard, and precleaned in accordance with recommended E.P.A. Protocol*

CLASS 1: (Standard) Containers are assembled with liner and closure without washing treatment.

CLASS 2: (Precleaned) Containers are processed according to EPA recommended wash procedures. Washed with laboratory grade biodegradable, non-phosphate detergent, rinsed with ASTM Type I De-ionized water, oven dried, and assembled in a contaminate-free environment. The exterior of each case is labeled with a lot number. Each case contains a copy of wash "Standard Operating Procedure."

Standard

Assembled with White Polypropylene Closure, F217 Lined

HDPE Wide Mouth Jars - Class 1

Cat. No.	Description	Qty
9-200	2 oz, 60mL Wide Mouth Jar, 33-400mm Thread, White Polypropylene Closure, F217 Lined	24 Pack
9-200B	2 oz, 60mL Wide Mouth Jar, 33-400mm Thread, White Polypropylene Closure, F217 Lined - Bulk Pack	960 Pieces
9-201	4 oz, 120mL Wide Mouth Jar, 38-400mm Thread, White Polypropylene Closure, F217 Lined	24 Pack
9-201B	4 oz, 120mL Wide Mouth Jar, 38-400mm Thread, White Polypropylene Closure, F217 Lined - Bulk Pack	540 Pieces
9-202	8 oz, 250mL Wide Mouth Jar, 53-400mm Thread, White Polypropylene Closure, F217 Lined	24 Pack
9-202B	8 oz, 250mL Wide Mouth Jar, 53-400mm Thread, White Polypropylene Closure, F217 Lined - Bulk Pack	230 Pieces
9-203	16 oz, 500mL Wide Mouth Jar, 53-400mm Thread, White Polypropylene Closure, F217 Lined	12 Pack
9-203B	16 oz, 500mL Wide Mouth Jar, 53-400mm Thread, White Polypropylene Closure, F217 Lined - Bulk Pack	144 Pieces
9-204	32 oz, 1000mL Wide Mouth Jar, 53-400mm Thread, White Polypropylene Closure, F217 Lined	12 Pack
9-204B	32 oz, 1000mL Wide Mouth Jar, 53-400mm Thread, White Polypropylene Closure, F217 Lined - Bulk Pack	72 Pieces
9-205	68 oz, 2000mL Wide Mouth Jar, 100-400mm Thread, White Polypropylene Closure, F217 Lined	6 Pack
9-205B	68 oz, 2000mL Wide Mouth Jar, 100-400mm Thread, White Polypropylene Closure, F217 Lined - Bulk Pack	30 Pieces
9-206	128 oz, 4000mL Wide Mouth Jar, 110-400mm Thread, White Polypropylene Closure, F217 Lined	4 Pack
9-206B	128 oz, 4000mL Wide Mouth Jar, 110-400mm Thread, White Polypropylene Closure, F217 Lined - Bulk Pack	12 Pieces

*Don't see what you are looking for?
Please contact us. Any combination of products is available.*

High Density Polyethylene Wide Mouth Jars

Precleaned

Assembled with White Polypropylene Closure, F217 Lined

HDPE Wide Mouth Jars - Class 2		
Cat. No.	Description	Qty
9-200-2	2 oz, 60mL Wide Mouth Jar, 33-400mm Thread, White Polypropylene Closure, F217 Lined	24 Pack
9-200B-2	2 oz, 60mL Wide Mouth Jar, 33-400mm Thread, White Polypropylene Closure, F217 Lined - Bulk Pack	960 Pieces
9-201-2	4 oz, 120mL Wide Mouth Jar, 38-400mm Thread, White Polypropylene Closure, F217 Lined	24 Pack
9-201B-2	4 oz, 120mL Wide Mouth Jar, 38-400mm Thread, White Polypropylene Closure, F217 Lined - Bulk Pack	540 Pieces
9-202-2	8 oz, 250mL Wide Mouth Jar, 53-400mm Thread, White Polypropylene Closure, F217 Lined	24 Pack
9-202B-2	8 oz, 250mL Wide Mouth Jar, 53-400mm Thread, White Polypropylene Closure, F217 Lined - Bulk Pack	230 Pieces
9-203-2	16 oz, 500mL Wide Mouth Jar, 53-400mm Thread, White Polypropylene Closure, F217 Lined	12 Pack
9-203B-2	16 oz, 500mL Wide Mouth Jar, 53-400mm Thread, White Polypropylene Closure, F217 Lined - Bulk Pack	144 Pieces
9-204-2	32 oz, 1000mL Wide Mouth Jar, 53-400mm Thread, White Polypropylene Closure, F217 Lined	12 Pack
9-204B-2	32 oz, 1000mL Wide Mouth Jar, 53-400mm Thread, White Polypropylene Closure, F217 Lined - Bulk Pack	72 Pieces
9-205-2	68 oz, 2000mL Wide Mouth Jar, 100-400mm Thread, White Polypropylene Closure, F217 Lined	6 Pack
9-205B-2	68 oz, 2000mL Wide Mouth Jar, 100-400mm Thread, White Polypropylene Closure, F217 Lined - Bulk Pack	30 Pieces
9-206-2	128 oz, 4000mL Wide Mouth Jar, 110-400mm Thread, White Polypropylene Closure, F217 Lined	4 Pack
9-206B-2	128 oz, 4000mL Wide Mouth Jar, 110-400mm Thread, White Polypropylene Closure, F217 Lined - Bulk Pack	12 Pieces

*Don't see what you are looking for?
Please contact us. Any combination of products is available.*

High Density Polyethylene Narrow Mouth Bottles

Finneran Products Certified For Science™



HDPE Narrow Mouth Bottles

- *Preassembled with foamed polyethylene lined polypropylene closures*
- *All HDPE bottles and jars are also available with PTFE - lined closures or unlined closures.*
- *Available in standard, and precleaned in accordance with recommended E.P.A. Protocol*

CLASS 1: (Standard) Containers are assembled with liner and closure without washing treatment.

CLASS 2: (Pre-cleaned) Containers are processed according to EPA recommended wash procedures. Washed with laboratory grade biodegradable, non-phosphate detergent, rinsed with ASTM Type I De-ionized water, oven dried, and assembled in a contaminate-free environment. The exterior of each case is labeled with a lot number. Each case contains a copy of wash "Standard Operating Procedure."

Standard

Assembled with White Polypropylene Closure, F217 Lined

HDPE Narrow Mouth Bottles - Class 1

Cat. No.	Description	Qty
9-210	4 oz, 125mL Narrow Mouth Bottle, 20-410mm Thread, Polypropylene Closure, F217 Lined	24 Pack
9-210B	4 oz, 125mL Narrow Mouth Bottle, 20-410mm Thread, Polypropylene Closure, F217 Lined - Bulk Pack	470 Pieces
9-211	8 oz, 250mL Narrow Mouth Bottle, 24-410mm Thread, Polypropylene Closure, F217 Lined	24 Pack
9-211B	8 oz, 250mL Narrow Mouth Bottle, 24-410mm Thread, Polypropylene Closure, F217 Lined - Bulk Pack	230 Pieces
9-212	16 oz, 500mL Narrow Mouth Bottle, 24-410mm Thread, Polypropylene Closure, F217 Lined	12 Pack
9-212B	16 oz, 500mL Narrow Mouth Bottle, 24-410mm Thread, Polypropylene Closure, F217 Lined - Bulk Pack	144 Pieces
9-213	32 oz, 1000mL Narrow Mouth Bottle, 28-410mm Thread, Polypropylene Closure, F217 Lined	12 Pack
9-213B	32 oz, 1000mL Narrow Mouth Bottle, 28-410mm Thread, Polypropylene Closure, F217 Lined - Bulk Pack	84 Pieces

Precleaned

Assembled with White Polypropylene Closure, F217 Lined

HDPE Narrow Mouth Bottles - Class 2

Cat. No.	Description	Qty
9-210-2	4 oz, 125mL Narrow Mouth Bottle, 20-410mm Thread, Polypropylene Closure, F217 Lined	24 Pack
9-210B-2	4 oz, 125mL Narrow Mouth Bottle, 20-410mm Thread, Polypropylene Closure, F217 Lined - Bulk Pack	470 Pieces
9-211-2	8 oz, 250mL Narrow Mouth Bottle, 24-410mm Thread, Polypropylene Closure, F217 Lined	24 Pack
9-211B-2	8 oz, 250mL Narrow Mouth Bottle, 24-410mm Thread, Polypropylene Closure, F217 Lined - Bulk Pack	230 Pieces
9-212-2	16 oz, 500mL Narrow Mouth Bottle, 24-410mm Thread, Polypropylene Closure, F217 Lined	12 Pack
9-212B-2	16 oz, 500mL Narrow Mouth Bottle, 24-410mm Thread, Polypropylene Closure, F217 Lined - Bulk Pack	144 Pieces
9-213-2	32 oz, 1000mL Narrow Mouth Bottle, 28-410mm Thread, Polypropylene Closure, F217 Lined	12 Pack
9-213B-2	32 oz, 1000mL Narrow Mouth Bottle, 28-410mm Thread, Polypropylene Closure, F217 Lined - Bulk Pack	84 Pieces

*Don't see what you are looking for?
Please contact us. Any combination of products is available.*

Laboratory Grade Plastic Bottles

Finneran Products Certified For Science™



- Available in wide mouth or narrow mouth

- Available in natural or amber

CLASS 1: (Standard) Containers are assembled with liner and closure without washing treatment.

CLASS 2: (Prcleaned) Containers are processed according to EPA recommended wash procedures. Washed with laboratory grade biodegradable, non-phosphate detergent, rinsed with ASTM Type I De-ionized water, oven dried, and assembled in a contaminate-free environment. The exterior of each case is labeled with a lot number. Each case contains a copy of wash "Standard Operating Procedure."

Standard

Wide Mouth Plastic Laboratory Grade Bottles with Closure

High Density Polyethylene (HDPE), Natural - Class 1

Cat. No.	Description	Qty
D0433-4	125mL Natural Wide Mouth Laboratory Grade Bottle, 38mm Closure	24 Pack
D0433B-4	125mL Natural Wide Mouth Laboratory Grade Bottle, 38mm Closure - Bulk Pack	350 Pack
D0433-8	250mL Natural Wide Mouth Laboratory Grade Bottle, 45mm Closure	24 Pack
D0433B-8	250mL Natural Wide Mouth Laboratory Grade Bottle, 45mm Closure - Bulk Pack	180 Pack
D0433-16	500mL Natural Wide Mouth Laboratory Grade Bottle, 55mm Closure	12 Pack
D0433B-16	500mL Natural Wide Mouth Laboratory Grade Bottle, 55mm Closure - Bulk Pack	100 Pack
D0433-32	1000mL Natural Wide Mouth Laboratory Grade Bottle, 65mm Closure	12 Pack
D0433B-32	1000mL Natural Wide Mouth Laboratory Grade Bottle, 65mm Closure - Bulk Pack	55 Pack

High Density Polyethylene (HDPE), Amber - Class 1

Cat. No.	Description	Qty
D0434-4	125mL Amber Wide Mouth Laboratory Grade Bottle, 38mm Closure	24 Pack
D0434B-4	125mL Amber Wide Mouth Laboratory Grade Bottle, 38mm Closure - Bulk Pack	72 Pack
D0434-8	250mL Amber Wide Mouth Laboratory Grade Bottle, 45mm Closure	24 Pack
D0434B-8	250mL Amber Wide Mouth Laboratory Grade Bottle, 45mm Closure - Bulk Pack	72 Pack
D0434-16	500mL Amber Wide Mouth Laboratory Grade Bottle, 55mm Closure	12 Pack
D0434B-16	500mL Amber Wide Mouth Laboratory Grade Bottle, 55mm Closure - Bulk Pack	48 Pack
D0434-32	1000mL Amber Wide Mouth Laboratory Grade Bottle, 65mm Closure	12 Pack
D0434B-32	1000mL Amber Wide Mouth Laboratory Grade Bottle, 65mm Closure - Bulk Pack	24 Pack

Don't see what you are looking for?
Please contact us. Any combination of products is available.

Laboratory Grade Plastic Bottles

Standard

Narrow Mouth Plastic Laboratory Grade Bottles with Closures

High Density Polyethylene (HDPE), Natural - Class 1

Cat. No.	Description	Qty
D0437-4	125mL Natural Narrow Mouth Laboratory Grade Bottle, 28mm Closure	24 Pack
D0437B-4	125mL Natural Narrow Mouth Laboratory Grade Bottle, 28mm Closure - Bulk Pack	350 Pack
D0437-8	250mL Natural Narrow Mouth Laboratory Grade Bottle, 28mm Closure	24 Pack
D0437B-8	250mL Natural Narrow Mouth Laboratory Grade Bottle, 28mm Closure - Bulk Pack	180 Pack
D0437-16	500mL Natural Narrow Mouth Laboratory Grade Bottle, 28mm Closure	12 Pack
D0437B-16	500mL Natural Narrow Mouth Laboratory Grade Bottle, 28mm Closure - Bulk Pack	100 Pack
D0437-32	1000mL Natural Narrow Mouth Laboratory Grade Bottle, 28mm Closure	12 Pack
D0437B-32	1000mL Natural Narrow Mouth Laboratory Grade Bottle, 28mm Closure - Bulk Pack	55 Pack

High Density Polyethylene (HDPE), Amber - Class 1

Cat. No.	Description	Qty
D0438-4	125mL Amber Narrow Mouth Laboratory Grade Bottle, 28mm Closure	24 Pack
D0438B-4	125mL Amber Narrow Mouth Laboratory Grade Bottle, 28mm Closure - Bulk Pack	72 Pack
D0438-8	250mL Amber Narrow Mouth Laboratory Grade Bottle, 28mm Closure	24 Pack
D0438B-8	250mL Amber Narrow Mouth Laboratory Grade Bottle, 28mm Closure - Bulk Pack	72 Pack
D0438-16	500mL Amber Narrow Mouth Laboratory Grade Bottle, 28mm Closure	12 Pack
D0438B-16	500mL Amber Narrow Mouth Laboratory Grade Bottle, 28mm Closure - Bulk Pack	48 Pack
D0438-32	1000mL Amber Narrow Mouth Laboratory Grade Bottle, 28mm Closure	12 Pack
D0438B-32	1000mL Amber Narrow Mouth Laboratory Grade Bottle, 28mm Closure - Bulk Pack	24 Pack

*Don't see what you are looking for?
Please contact us. Any combination of products is available.*

Narrow Mouth Septum Bottles

Finneran Products Certified For Science™



- *Preassembled with PTFE/Silicone-lined open top black polypropylene closures*

- *Available in standard, precleaned, or precleaned/certified in accordance with recommended E.P.A. Protocol*

CLASS 1: (Standard) Containers are assembled with liner and closure without washing treatment.

CLASS 2: (Prcleaned) Containers are processed according to EPA recommended wash procedures. Washed with laboratory grade biodegradable, non-phosphate detergent, rinsed with ASTM Type I De-ionized water, oven dried, and assembled in a contaminate-free environment. The exterior of each case is labeled with a lot number. Each case contains a copy of wash “Standard Operating Procedure.”

CLASS 3: (Certified) Containers are processed according to EPA recommended wash procedures. Washed with laboratory grade biodegradable, non-phosphate detergent, rinsed with ASTM Type I De-ionized water, oven dried and assembled in a contaminate-free environment. The exterior of each case is labeled with a lot number. Each case contains a “Certificate of Analysis.”

An independent laboratory is used to certify the container’s cleanliness, assuring impartial results.

Standard

Assembled with Open Top Black Polypropylene (PP) Closures and Septum

Clear Glass Narrow Mouth Septum Bottles - Class 1

Cat. No.	Description	Qty
9-160	1 oz, 30mL Clear Septum Bottle, 20-400mm Thread, Black PP Closure, PTFE/Silicone Liner	24 Pack
9-161	2 oz, 60mL Clear Septum Bottle, 20-400mm Thread, Black PP Closure, PTFE/Silicone Liner	24 Pack
9-162	4 oz, 125mL Clear Septum Bottle, 22-400mm Thread, Black PP Closure, PTFE/Silicone Liner	24 Pack
9-163	8 oz, 250mL Clear Septum Bottle, 24-400mm Thread, Black PP Closure, PTFE/Silicone Liner	12 Pack

Amber Glass Narrow Mouth Septum Bottles - Class 1

Cat. No.	Description	Qty
9A-160	1 oz, 30mL Amber Septum Bottle, 20-400mm Thread, Black PP Closure, PTFE/Silicone Liner	24 Pack
9A-161	2 oz, 60mL Amber Septum Bottle, 20-400mm Thread, Black PP Closure, PTFE/Silicone Liner	24 Pack
9A-162	4 oz, 125mL Amber Septum Bottle, 22-400mm Thread, Black PP Closure, PTFE/Silicone Liner	24 Pack
9A-163	8 oz, 250mL Amber Septum Bottle, 24-400mm Thread, Black PP Closure, PTFE/Silicone Liner	12 Pack

*Don't see what you are looking for?
Please contact us. Any combination of products is available.*

Narrow Mouth Septum Bottles

Precleaned

Assembled with Open Top Black Polypropylene (PP) Closures and Septum

Clear Glass Narrow Mouth Septum Bottles - Class 2

Cat. No.	Description	Qty
9-160-2	1 oz, 30mL Clear Septum Bottle, 20-400mm Thread, Black PP Closure, PTFE/Silicone Liner	24 Pack
9-161-2	2 oz, 60mL Clear Septum Bottle, 20-400mm Thread, Black PP Closure, PTFE/Silicone Liner	24 Pack
9-162-2	4 oz, 125mL Clear Septum Bottle, 22-400mm Thread, Black PP Closure, PTFE/Silicone Liner	24 Pack
9-163-2	8 oz, 250mL Clear Septum Bottle, 24-400mm Thread, Black PP Closure, PTFE/Silicone Liner	12 Pack

Amber Glass Narrow Mouth Septum Bottles - Class 2

Cat. No.	Description	Qty
9A-160-2	1 oz, 30mL Amber Septum Bottle, 20-400mm Thread, Black PP Closure, PTFE/Silicone Liner	24 Pack
9A-161-2	2 oz, 60mL Amber Septum Bottle, 20-400mm Thread, Black PP Closure, PTFE/Silicone Liner	24 Pack
9A-162-2	4 oz, 125mL Amber Septum Bottle, 22-400mm Thread, Black PP Closure, PTFE/Silicone Liner	24 Pack
9A-163-2	8 oz, 250mL Amber Septum Bottle, 24-400mm Thread, Black PP Closure, PTFE/Silicone Liner	12 Pack

Precleaned and Certified

Assembled with Open Top Black Polypropylene (PP) Closures and Septum

Clear Glass Narrow Mouth Septum Bottles - Class 3

Cat. No.	Description	Qty
9-160-3	1 oz, 30mL Clear Septum Bottle, 20-400mm Thread, Black PP Closure, PTFE/Silicone Liner	24 Pack
9-161-3	2 oz, 60mL Clear Septum Bottle, 20-400mm Thread, Black PP Closure, PTFE/Silicone Liner	24 Pack
9-162-3	4 oz, 125mL Clear Septum Bottle, 22-400mm Thread, Black PP Closure, PTFE/Silicone Liner	24 Pack
9-163-3	8 oz, 250mL Clear Septum Bottle, 24-400mm Thread, Black PP Closure, PTFE/Silicone Liner	12 Pack

Amber Glass Narrow Mouth Septum Bottles - Class 3

Cat. No.	Description	Qty
9A-160-3	1 oz, 30mL Amber Septum Bottle, 20-400mm Thread, Black PP Closure, PTFE/Silicone Liner	24 Pack
9A-161-3	2 oz, 60mL Amber Septum Bottle, 20-40mm Thread, Black PP Closure, PTFE/Silicone Liner	24 Pack
9A-162-3	4 oz, 125mL Amber Septum Bottle, 22-400mm Thread, Black PP Closure, PTFE/Silicone Liner	24 Pack
9A-163-3	8 oz, 250mL Amber Septum Bottle, 24-400mm Thread, Black PP Closure, PTFE/Silicone Liner	12 Pack

*Don't see what you are looking for?
Please contact us. Any combination of products is available.*

Wide Mouth Septum Jars

Finneran Products Certified For Science™



-Preassembled with ultrasonically welded PTFE/Silicone liner

-Available in standard, precleaned or precleaned/certified in accordance with recommended E.P.A. Protocol

CLASS 1: (Standard) Containers are assembled with liner and closure without washing treatment.

CLASS 2: (Precleaned) Containers are processed according to EPA recommended wash procedures. Washed with laboratory grade biodegradable, non-phosphate detergent, rinsed with ASTM Type I De-ionized water, oven dried, and assembled in a contaminate-free environment. The exterior of each case is labeled with a lot number. Each case contains a copy of wash "Standard Operating Procedure."

CLASS 3: (Certified) Containers are processed according to EPA recommended wash procedures. Washed with laboratory grade biodegradable, non-phosphate detergent, rinsed with ASTM Type I De-ionized water, oven dried and assembled in a contaminate-free environment. The exterior of each case is labeled with a lot number. Each case contains a "Certificate of Analysis."

An independent laboratory is used to certify the container's cleanliness, assuring impartial results.

Standard

Assembled with Open Top White Polypropylene Closures and Septum

Tall Straight Sided Wide Mouth Septum Jars - Class 1

Cat. No.	Description	Qty
9-141	4 oz, 125mL Clear Tall Septum Jar, 48-400mm Closure, PTFE/Silicone Liner	24 Pack
9-142	8 oz, 250mL Clear Tall Septum Jar, 58-400mm Closure, PTFE/Silicone Liner	12 Pack

Short Straight Sided Wide Mouth Septum Jars - Class 1

Cat. No.	Description	Qty
9-140	2 oz, 60mL Clear Short Septum Jar, 53-400mm Closure, PTFE/Silicone Liner	24 Pack

Amber Glass Wide Mouth Packers - Class 1

Cat. No.	Description	Qty
9-150	500cc Amber Packer, 53-400mm Closure, PTFE/Silicone Liner	12 Pack
9-151	950cc Amber Packer, 53-400mm Closure, PTFE/Silicone Liner	12 Pack

*Don't see what you are looking for?
Please contact us. Any combination of products is available.*

Wide Mouth Septum Jars

Precleaned

Assembled with Open Top White Polypropylene Closures and Septum

Tall Straight Sided Wide Mouth Septum Jars - Class 2

Cat. No.	Description	Qty
9-141-2	4 oz, 125mL Clear Tall Septum Jar, 48-400mm Closure, PTFE/Silicone Liner	24 Pack
9-142-2	8 oz, 250mL Clear Tall Septum Jar, 58-400mm Closure, PTFE/Silicone Liner	12 Pack

Short Straight Sided Wide Mouth Septum Jars - Class 2

Cat. No.	Description	Qty
9-140-2	2 oz, 60mL Clear Short Septum Jar, 53-400mm Closure, PTFE/Silicone Liner	24 Pack

Amber Glass Wide Mouth Packers - Class 2

Cat. No.	Description	Qty
9-150-2	500cc Amber Packer, 53-400mm Closure, PTFE/Silicone Liner	12 Pack
9-151-2	950cc Amber Packer, 53-400mm Closure, PTFE/Silicone Liner	12 Pack

Precleaned and Certified

Assembled with Open Top White Polypropylene Closures and Septum

Tall Straight Sided Wide Mouth Septum Jars - Class 3

Cat. No.	Description	Qty
9-141-3	4 oz, 125mL Clear Tall Septum Jar, 48-400mm Closure, PTFE/Silicone Liner	24 Pack
9-142-3	8 oz, 250mL Clear Tall Septum Jar, 58-400mm Closure, PTFE/Silicone Liner	12 Pack

Short Straight Sided Wide Mouth Septum Jars - Class 3

Cat. No.	Description	Qty
9-140-3	2 oz, 60mL Clear Short Septum Jar, 53-400mm Closure, PTFE/Silicone Liner	24 Pack

Amber Glass Wide Mouth Packers - Class 3

Cat. No.	Description	Qty
9-150-3	500cc Amber Packer, 53-400mm Closure, PTFE/Silicone Liner	12 Pack
9-151-3	950cc Amber Packer, 53-400mm Closure, PTFE/Silicone Liner	12 Pack

*Don't see what you are looking for?
Please contact us. Any combination of products is available.*

Wide Mouth Straight Sided Polypropylene Plastic Jars

Finneran Products Certified For Science™



Standard

- Closures available with additional lining materials

CLASS 1: (Standard) Containers are assembled with liner and closure without washing treatment.

Assembled with White Polypropylene Closure, F217 Lined

Wide Mouth Straight Sided Polypropylene Jars - Class 1

Cat. No.	Description	Qty
D0044-1	1 oz, 30mL Polypropylene Jar, 43-400mm Closure, F217 Lined	24 Pack
D0044B-1	1 oz, 30mL Polypropylene Jar, 43-400mm Closure, F217 Lined - Bulk Pack	1144 Pieces
D0044-2	2 oz, 60mL Polypropylene Jar, 53-400mm Closure, F217 Lined	24 Pack
D0044B-2	2 oz, 60mL Polypropylene Jar, 53-400mm Closure, F217 Lined - Bulk Pack	420 Pieces
D0044-4	4 oz, 125mL Polypropylene Jar, 58-400mm Closure, F217 Lined	24 Pack
D0044B-4	4 oz, 125mL Polypropylene Jar, 58-400mm Closure, F217 Lined - Bulk Pack	324 Pieces
D0044-8	8 oz, 250mL Polypropylene Jar, 70-400mm Closure, F217 Lined	24 Pack
D0044B-8	8 oz, 250mL Polypropylene Jar, 70-400mm Closure, F217 Lined - Bulk Pack	175 Pieces
D0044-16	16 oz, 500mL Polypropylene Jar, 89-400mm Closure, F217 Lined	12 Pack
D0044B-16	16 oz, 500mL Polypropylene Jar, 89-400mm Closure, F217 Lined - Bulk Pack	140 Pieces
D0044-32	32 oz, 950mL Polypropylene Jar, 120-400mm Closure, F217 Lined	12 Pack
D0044B-32	32 oz, 950mL Polypropylene Jar, 120-400mm Closure, F217 Lined - Bulk Pack	48 Pieces

Assembled with White Polypropylene Closure, Unlined

Wide Mouth Straight Sided Polypropylene Jars - Class 1

Cat. No.	Description	Qty
D0045-1	1 oz, 30mL Polypropylene Jar, 43-400mm Closure, Unlined	24 Pack
D0045B-1	1 oz, 30mL Polypropylene Jar, 43-400mm Closure, Unlined - Bulk Pack	1144 Pieces
D0045-2	2 oz, 60mL Polypropylene Jar, 53-400mm Closure, Unlined	24 Pack
D0045B-2	2 oz, 60mL Polypropylene Jar, 53-400mm Closure, Unlined - Bulk Pack	420 Pieces
D0045-4	4 oz, 125mL Polypropylene Jar, 58-400mm Closure, Unlined	24 Pack
D0045B-4	4 oz, 125mL Polypropylene Jar, 58-400mm Closure, Unlined - Bulk Pack	324 Pieces
D0045-8	8 oz, 250mL Polypropylene Jar, 70-400mm Closure, Unlined	24 Pack
D0045B-8	8 oz, 250mL Polypropylene Jar, 70-400mm Closure, Unlined - Bulk Pack	175 Pieces
D0045-16	16 oz, 500mL Polypropylene Jar, 89-400mm Closure, Unlined	12 Pack
D0045B-16	16 oz, 500mL Polypropylene Jar, 89-400mm Closure, Unlined - Bulk Pack	140 Pieces
D0045-32	32 oz, 950mL Polypropylene Jar, 120-400mm Closure, Unlined	12 Pack
D0045B-32	32 oz, 950mL Polypropylene Jar, 120-400mm Closure, Unlined - Bulk Pack	48 Pieces

*Don't see what you are looking for?
Please contact us. Any combination of products is available.*

PTFE Cap Liners and Solid Top Closures

Finneran Products Certified For Science™



- Solid virgin PTFE liners can be manually inserted into closure and maintains a snug friction fit.

- PTFE liners are also available in other sizes and thicknesses

PTFE Cap Liners

PTFE Cap Liners .015" Thick

Cat. No.	Description	Qty
38-134	18mm PTFE Liner	100 Pack
38-136	20mm PTFE Liner	100 Pack
38-138	22mm PTFE Liner	100 Pack
38-140	24mm PTFE Liner	100 Pack
38-142	28mm PTFE Liner	100 Pack
38-144	33mm PTFE Liner	100 Pack
38-146	38mm PTFE Liner	100 Pack
38-148	43mm PTFE Liner	100 Pack
38-150	45mm PTFE Liner	100 Pack
38-152	48mm PTFE Liner	100 Pack
38-154	53mm PTFE Liner	100 Pack
38-156	58mm PTFE Liner	100 Pack
38-158	63mm PTFE Liner	100 Pack
38-160	70mm PTFE Liner	100 Pack
38-162	83mm PTFE Liner	100 Pack
38-164	89mm PTFE Liner	100 Pack

*Don't see what you are looking for?
Please contact us. Any combination of products is available.*

PTFE Cap Liners and Solid Top Closures



Solid Top Closures

- Closures available with various lining materials

Phenolic Closures - Polycone Lined

Cat. No.	Description	Qty
D0396-13	13-425mm Phenolic Cap/PE Cone Lined	100 Pack
D0396-15	15-425mm Phenolic Cap/PE Cone Lined	100 Pack
D0396-18	18-400mm Phenolic Cap/PE Cone Lined	100 Pack
D0396-20	20-400mm Phenolic Cap/PE Cone Lined	100 Pack
D0396-22	22-400mm Phenolic Cap/PE Cone Lined	100 Pack
D0396-24	24-400mm Phenolic Cap/PE Cone Lined	100 Pack
D0396-28	28-400mm Phenolic Cap/PE Cone Lined	100 Pack
D0396-33	33-400mm Phenolic Cap/PE Cone Lined	100 Pack
D0396-38	38-400mm Phenolic Cap/PE Cone Lined	100 Pack

Polypropylene Closures - PTFE Lined

Cat. No.	Description	Qty
D0399-13	13-425mm White Polypropylene Closure/PTFE Lined	100 Pack
D0399-15	15-425mm White Polypropylene Closure/PTFE Lined	100 Pack
D0399-18	18-400mm White Polypropylene Closure/PTFE Lined	100 Pack
D0399-20	20-400mm White Polypropylene Closure/PTFE Lined	100 Pack
D0399-22	22-400mm White Polypropylene Closure/PTFE Lined	100 Pack
D0399-24	24-400mm White Polypropylene Closure/PTFE Lined	100 Pack
D0399-28	28-400mm White Polypropylene Closure/PTFE Lined	100 Pack
D0399-33	33-400mm White Polypropylene Closure/PTFE Lined	100 Pack
D0399-38	38-400mm White Polypropylene Closure/PTFE Lined	100 Pack
D0399-43	43-400mm White Polypropylene Closure/PTFE Lined	100 Pack
D0399-45	45-400mm White Polypropylene Closure/PTFE Lined	100 Pack
D0399-48	48-400mm White Polypropylene Closure/PTFE Lined	100 Pack
D0399-53	53-400mm White Polypropylene Closure/PTFE Lined	100 Pack
D0399-58	58-400mm White Polypropylene Closure/PTFE Lined	100 Pack
D0399-63	63-400mm White Polypropylene Closure/PTFE Lined	100 Pack
D0399-70	70-400mm White Polypropylene Closure/PTFE Lined	100 Pack
D0399-89	89-400mm White Polypropylene Closure/PTFE Lined	100 Pack

*Don't see what you are looking for?
Please contact us. Any combination of products is available.*

PTFE Cap Liners and Solid Top Closures

Solid Top Closures

Polypropylene Closures - F217 Lined

Cat. No.	Description	Qty
D0400-18	18-400mm White Polypropylene Closure/F217 Lined	100 Pack
D0400-20	20-400mm White Polypropylene Closure/F217 Lined	100 Pack
D0400-22	22-400mm White Polypropylene Closure/F217 Lined	100 Pack
D0400-24	24-400mm White Polypropylene Closure/F217 Lined	100 Pack
D0400-28	28-400mm White Polypropylene Closure/F217 Lined	100 Pack
D0400-33	33-400mm White Polypropylene Closure/F217 Lined	100 Pack
D0400-38	38-400mm White Polypropylene Closure/F217 Lined	100 Pack
D0400-43	43-400mm White Polypropylene Closure/F217 Lined	100 Pack
D0400-45	45-400mm White Polypropylene Closure/F217 Lined	100 Pack
D0400-48	48-400mm White Polypropylene Closure/F217 Lined	100 Pack
D0400-53	53-400mm White Polypropylene Closure/F217 Lined	100 Pack
D0400-58	58-400mm White Polypropylene Closure/F217 Lined	100 Pack
D0400-63	63-400mm White Polypropylene Closure/F217 Lined	100 Pack
D0400-70	70-400mm White Polypropylene Closure/F217 Lined	100 Pack
D0400-89	89-400mm White Polypropylene Closure/F217 Lined	100 Pack

Polypropylene Closures - Unlined

Cat. No.	Description	Qty
D0402-18	18-400mm White Polypropylene Closure/Unlined	100 Pack
D0402-20	20-400mm White Polypropylene Closure/Unlined	100 Pack
D0402-22	22-400mm White Polypropylene Closure/Unlined	100 Pack
D0402-24	24-400mm White Polypropylene Closure/Unlined	100 Pack
D0402-28	28-400mm White Polypropylene Closure/Unlined	100 Pack
D0402-33	33-400mm White Polypropylene Closure/Unlined	100 Pack
D0402-38	38-400mm White Polypropylene Closure/Unlined	100 Pack
D0402-43	43-400mm White Polypropylene Closure/Unlined	100 Pack
D0402-45	45-400mm White Polypropylene Closure/Unlined	100 Pack
D0402-48	48-400mm White Polypropylene Closure/Unlined	100 Pack
D0402-53	53-400mm White Polypropylene Closure/Unlined	100 Pack
D0402-58	58-400mm White Polypropylene Closure/Unlined	100 Pack
D0402-63	63-400mm White Polypropylene Closure/Unlined	100 Pack
D0402-70	70-400mm White Polypropylene Closure/Unlined	100 Pack
D0402-89	89-400mm White Polypropylene Closure/Unlined	100 Pack

*Don't see what you are looking for?
Please contact us. Any combination of products is available.*

Standard EPA Vial Box Configuration

Finneran Products Certified For Science™



72 pack: 20 & 40ml vials



100 pack: 20 & 40ml vials



144 pack: 20, 40 & 60ml vials



72 pack: 60ml vials

Other packaging configurations may be available.
Please contact Customer Service.